

Installation, Operation, Maintenance Manual



IntelliROL® Motorized Roller Conveyor

IOM Part Number: 90480001

Revision Date: February 16, 2023



[Para la OIM española Seleccione Aquí](#)

Table of Contents

- 1 IOM INTRODUCTION 7**
- 2 MHS CONVEYOR POLICIES 8**
 - 2.1 MHS RECOMMENDS PROPER LABELS FOR CONVEYOR TYPES..... 10
 - 2.2 WARNINGS AND SAFETY INSTRUCTIONS 11
 - 2.3 MHS CONVEYOR CONTROLS SAFETY GUIDELINES 14
- 3 INTELLIROL INTRODUCTION 16**
 - 3.1 INTELLIROL APPLICATION OPTIONS 18
 - 3.2 DEFINITION OF TERMS 19
- 4 INTELLIROL RECEIVING & SITE PREPARATION 20**
 - 4.1 PARTS INVENTORY & IDENTIFICATION 21
- 5 INTELLIROL INSTALLATION 23**
 - 5.1 ENVIRONMENT 25
 - 5.2 SUPPORTS & CONNECTIONS 25
 - 5.3 GAP FILLER BED 26
 - 5.4 DIMENSIONAL REFERENCE POINTS 27
 - 5.5 INTELLIROL INSTALLATION 28
 - 5.6 ELEVATIONS..... 29
- 6 INTELLIROL APPLICATIONS..... 31**
 - 6.1 ITR APPLICATION STANDARD 31
 - 6.2 ITR – CBM-105 (TRANSPORTATION)..... 31
 - 6.3 ITR – HB-510 (ACCUMULATION)..... 31
 - 6.4 ITR – IB-E03 (PROGRAMMABLE) 31
 - 6.5 ITR BED CONSTRUCTION..... 32
 - 6.6 ITR FULL WIDTH BELT BED CONSTRUCTION..... 32
 - 6.7 ITR SKEW BED CONSTRUCTION 32
 - 6.8 CURVE CONSTRUCTION 32
 - 6.9 UBT PNEUMATIC CONSTRUCTION..... 33
 - 6.10 UBT ELECTRIC CONSTRUCTION 33
 - 6.11 MERGE BEDS 33
 - 6.12 POWER MERGE CONSTRUCTION 33

6.13 WHEEL DIVERT PNEUMATIC CONSTRUCTION 34

6.14 WHEEL DIVERT ELECTRIC CONSTRUCTION 34

6.15 SPUR CONSTRUCTION..... 34

6.16 ITR GATE 34

7 DESCRIPTION OF OPERATION 35

7.1 INTELLIROL ELECTRIC UBT (URETHANE BELT TRANSFER) 35

7.2 INTELLIROL ELECTRIC WHEEL DIVERTER 38

8 ITR SKEWING BED ROLLERS..... 40

8.1 FACTORY SKEW SECTION 40

8.2 SKEW BED INSTALLATION..... 40

9 ITR GATE..... 41

9.1 LIFT GATE MAXIMUM CYCLES: 42

10 INTELLIROL AIR SUPPLY REQUIREMENTS 43

10.1 LOW PRESSURE SWITCH..... 44

10.2 PNEUMATIC REQUIREMENTS 44

11 INTELLIROL POWER SUPPLY STANDARDS..... 45

11.1 ITR POWER SUPPLY STANDARD..... 45

11.2 ITR AND CRUZCONTROL POWER SUPPLY COMBINATION..... 47

11.3 ITR POWER SUPPLY MOTOR CONTROL..... 47

11.4 ITR POWER SUPPLY MOUNTING BRACKET KITS 48

12 GENERAL ELECTRICAL REQUIREMENTS 49

12.1 CRUZCONTROL TECHNICAL DATA 51

13 ITOH DENKI CBM-105 & CB-016 DRIVERCARD 52

13.1 CBM-105 & CB-016 DRIVERCARD GENERAL NOTES: 52

13.2 CBM-105 & CB-016 FEATURES: 52

13.3 CBM-105 & CB-016 SPECIFICATIONS: 53

14 ITOH DENKI HB-510 DRIVERCARD..... 64

14.1 HB-510 GENERAL NOTES..... 64

14.2 HB-510 FEATURES 65

14.3 ITR HB-510 ELECTRICAL COMPONENTS..... 66

14.4 ACCUMULATION CHARGE ZONE PRESSURE SWITCH ASSEMBLY 79

14.6 DISCHARGE LOGIC CTRL PRESSURE SWITCH KITS 80

15 ITOH DENKI IB-E03 DRIVERCARD83

15.1 IB-E03 GENERAL NOTES:83

15.2 IB-E03 FEATURES83

15.3 IB-E03 OPERATING ENVIRONMENT84

15.4 IB-E03 POWER REQUIREMENTS84

15.5 IB-E03 APPLICABLE POWER ROLLERS (MOTORIZED ROLLERS)85

15.6 IB-E03 ELECTRICAL COMPONENTS.....86

15.7 IB-E03 HARDWARE CONNECTIONS.....89

15.8 IB-E03 ROTARY SWITCHES AND DIP SWITCHES91

15.9 IB-E03 IP ADDRESS SUBNET92

15.10 IB-E03 MODULE STATUS INDICATORS93

15.11 IB-E03 LAN AND SENSOR STATUS INDICATORS94

15.12 IB-E03 REMOTE (AUXILIARY) I/O STATUS INDICATORS.....95

15.13 IB-E03 MOTOR ACTIVITY AND FUNCTION INDICATORS96

16 IB-E03 TROUBLESHOOTING – MOTOR DRIVER.....97

16.1 IB-E03 PHYSICAL BEHAVIOR98

16.2 IB-E03 SOFTWARE ISSUES99

16.3 IB-E03 MODULE RESET.....100

17 ITR MAINTENANCE & TROUBLESHOOTING 101

17.1 ITR TROUBLESHOOTING GUIDE.....103

18 INTELLIROL REPLACEMENT PARTS..... 107

18.1 REPLACEMENT PARTS IDENTIFICATION107

18.2 SPARE PARTS PRIORITY LEVEL EXPLANATIONS107

18.3 REPLACEMENT PARTS - ITOH FE60 MDR108

18.4 REPLACEMENT PARTS - ITOH DRIVERCARD STANDARDS108

18.5 DRIVE AND SLAVE O-RINGS109

18.6 RUN SIGNALS FOR CB-016 DRIVER CARD109

18.7 GENERAL CABLES, CONNECTORS, & KITS.....109

18.8 STANDARD ITR 24VDC POWER HARNESS.....110

18.9 CAT5 COMMUNICATION CABLES110

18.10 RUN SIGNAL HARNESS FOR CB-016 DRIVER CARD.....110

18.11 GENERAL CABLES, CONNECTORS & KITS111

18.12 CABLE, MOTOR EXTENSION USED WITH CBM-105, CB-016 OR HB-510 111

18.13 CABLE, MOTOR EXTENSION USED WITH IB-E03..... 111

18.14 COATED ROLLERS..... 111

18.15 ITR ADDITIONAL POWER HARNESS 112

18.16 HARNESS, GENDER CHANGING 114

18.17 PHOTOEYE AND PRESSURE SWITCH 115

18.18 SHROUDS 116

18.19 ACCUMULATION STRAIGHT BED ZONE 117

18.20 ITR TRANSPORTATION STRAIGHT BED..... 119

18.21 ITR SKEW BED 120

18.22 ITR ACCUMULATION CURVES 121

18.23 ITR TRANSPORTATION CURVES 125

18.24 ITR FWB HORIZONTAL / DECLINE BED 24 & 30 ZONES 128

18.25 ITR FWB HORIZONTAL / INCLINE BED 24 & 30 ZONE 130

18.26 NOSEOVER DECLINE (ACCUMULATION)..... 131

18.27 NOSEOVER INCLINE (ACCUMULATION) 133

18.28 NOSEOVER DECLINE (TRANSPORTATION)..... 135

18.29 NOSEOVER INCLINE (TRANSPORTATION) 137

18.30 NOSEUNDER DECLINE (ACCUMULATION) 139

18.31 NOSEUNDER INCLINE (ACCUMULATION) 141

18.32 NOSEUNDER DECLINE (TRANSPORTATION) 143

18.33 NOSEUNDER INCLINE (TRANSPORTATION) 146

18.34 ITR SPUR TRANSPORTATION 30 DEGREE..... 148

18.35 ITR SPUR TRANSPORTATION 45 DEGREE..... 161

18.36 ITR MERGE 171

18.37 ITR MERGE BRACKET KIT 30 & 45 DEGREE 172

18.38 ITR POWER MERGE..... 173

18.39 ITR SWEEP SPUR 45 DEGREE..... 178

18.40 ITR WHEEL DIVERT (PNEUMATIC)..... 182

18.41 ITR WHEEL DIVERTER (PNEUMATIC LIFT)..... 187

18.42 ITR WHEEL DIVERT (ELECTRIC LIFT)..... 188

18.43 ITR WHEEL DIVERTER (ELECTRIC LIFT) 191

18.44 ITR WHEEL DIVERTER (ELECTRIC LIFT) - ELECTRICAL COMPONENTS193

18.45 ITR UBT (PNEUMATIC LIFT) - MECHANICAL COMPONENTS 5S & 6S.....194

18.46 ITR UBT (PNEUMATIC LIFT) - ELECTRICAL COMPONENTS CB, 5S & 6S.....197

18.47 ITR UBT (PNEUMATIC LIFT) - ELECTRICAL COMPONENTS IB-E03, 5S & 6S198

18.48 ITR UBT (ELECTRIC LIFT) - MECHANICAL COMPONENTS 5S & 6S.....199

18.49 ITR UBT, (ELECTRIC LIFT) - ELECTRICAL COMPONENTS IB-E03, 5S & 6S201

18.50 ITR UBT LIFT TABLE TRANSFER OPTIONAL SPARE PARTS202

18.51 ITR GATE.....203

INTELLIROL REVISION HISTORY 208

WORKS CITED..... 208

MHS CONVEYOR GENERAL INFORMATION..... 208

ABOUT MHS CONVEYOR 209

1 IOM INTRODUCTION

IOM Purpose

It is the intent of MHS Conveyor, through this manual, to provide information that acts as a guide in the installation, operation, and maintenance of MHS Conveyor conveyors.

This manual describes basic installation practices, assembly arrangements, preventive maintenance, and assists in replacement parts identification.

This service manual is intended for use by personnel who are knowledgeable of installation and safe working practices on conveyor systems.

Not all applications and conditions can be covered; therefore, this manual is to be used ONLY as a guide. Proper training of operating and maintenance personnel is required by the owner/operator of the equipment

If additional copies of this manual are needed or if you have any question concerning the conveyor, please contact your MHS Distributor or MHS Lifetime Services at 231-798-4547 or visit MHS at mhs-conveyor.com for maintenance videos and other application information.

Manual Structure

You should receive a separate documentation for each product line of MHS Conveyor implemented in your installation. You can identify the respective product line on the back of the folder or on the cover sheet of the IOM (Installation Operation Maintenance Manual)

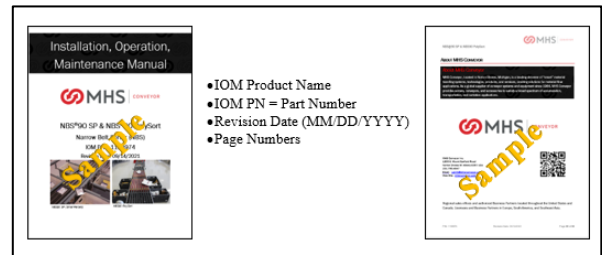

⚠ WARNING



- Pay attention to the safety instructions!
- Prior to working at or in the immediate vicinity of the system it is recommended that you make yourself familiar with the safety instructions included in the present document!

2 MHS CONVEYOR POLICIES

MHS Conveyor Equipment Warranty

MHS Conveyor warrants that the material and workmanship entering into its equipment is merchantable and will be furnished in accordance with the specifications stated.

MHS Conveyor agrees to furnish the purchaser without charge any part proved defective within 2 years from date of shipment provided the purchaser gives MHS Conveyor immediate notice in writing and examination proves the claim that such materials or parts were defective when furnished. For drive components specific to XenoROL® (i.e., Xeno belts, slave Xeno belts, drive spools, standard and speed-up, and spacers), this warranty shall be extended to five years of running use, provided the conveyors are applied, installed and maintained in accordance with MHS Conveyor published standards. Other than the above, there are no warranties which extend beyond the description on the face hereof. Consequential damages of any sort are wholly excluded.

The liability of MHS Conveyor will be limited to the replacement cost of any defective part. All freight and installation costs relative to any warranted part will be at the expense of the purchaser. Any liability of MHS Conveyor under the warranties specified above is conditioned upon the equipment being installed, handled, operated, and maintained in accordance with the written instructions provided or approved in writing by MHS Conveyor.

The warranties specified above do not cover, and MHS Conveyor makes no warranties which extend to, damage to the equipment due to deterioration or wear occasioned by chemicals, abrasion, corrosion or erosion; Purchaser's misapplication, abuse, alteration, operation or maintenance; abnormal conditions of temperature or dirt; or operation of the equipment above rated capacities or in an otherwise improper manner.

THERE ARE NO WARRANTIES, EXPRESSED OR IMPLIED, INCLUDING, BUT NOT LIMITED TO, WARRANTIES OF MERCHANTABILITY OR FITNESS FOR A PARTICULAR PURPOSE, EXTENDING BEYOND THOSE SET FORTH IN THIS STATEMENT OF WARRANTY.

Rev 08/12/2021



MHS Environment Standards

MHS Conveyor equipment is designed to be installed in a clean, dry warehouse environment. Exposure to extreme humidity, direct sunlight, blowing dirt or rain can permanently damage some components of MHS Conveyor. In particular, the curing agents in concrete are known to attack and degrade the urethane conveyor components.

When installing conveyor on a new construction site, be sure that the concrete is properly cured before setting conveyor on it. In addition, if conveyors are stored in the proximity of curing concrete, proper ventilation must be used to direct the curing agent fumes away from the conveyor.

Failure to comply with these guidelines will void the MHS warranty on any failed components that result from these environment issues.

08/12/2021

 WARNING	
	<ul style="list-style-type: none">• Safety: Always lock out power source and follow recommended safety procedures. https://www.osha.gov/

2.1 MHS RECOMMENDS PROPER LABELS FOR CONVEYOR TYPES

Shown below are some samples of labels applicable to conveyor standards.



CEMA Package Conveyors

SAFETY IS IN YOUR HANDS

POST IN PROMINENT AREA

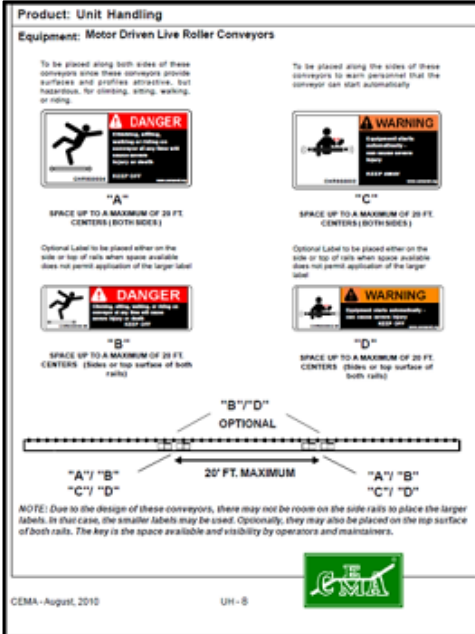

Product: Unit Handling
Equipment: Motor Driven Live Roller Conveyors

To be placed along both sides of these conveyors since these conveyors provide surfaces and profiles attractive, but hazardous, for climbing, sitting, walking or riding.

To be placed along the sides of these conveyors to warn personnel that the conveyor can start automatically.

"A"
SPACE UP TO A MAXIMUM OF 20 FT. CENTERS (BOTH SIDES)

"C"
SPACE UP TO A MAXIMUM OF 20 FT. CENTERS (BOTH SIDES)

Optional Label to be placed either on the side or top of rails when space available does not permit application of the larger label.

"B"
SPACE UP TO A MAXIMUM OF 20 FT. CENTERS (Sides or top surface of both rails)

"D"
SPACE UP TO A MAXIMUM OF 20 FT. CENTERS (Sides or top surface of both rails)

"B"/"D" OPTIONAL

"A"/"B" 20' FT. MAXIMUM "C"/"D"

NOTE: Due to the design of these conveyors, there may not be room on the side rails to place the larger labels. In that case, the smaller labels may be used. Optionally, they may also be placed on the top surface of both rails. The key is the space available and visibility by operators and maintainers.

CEMA - August, 2010 UH - 5

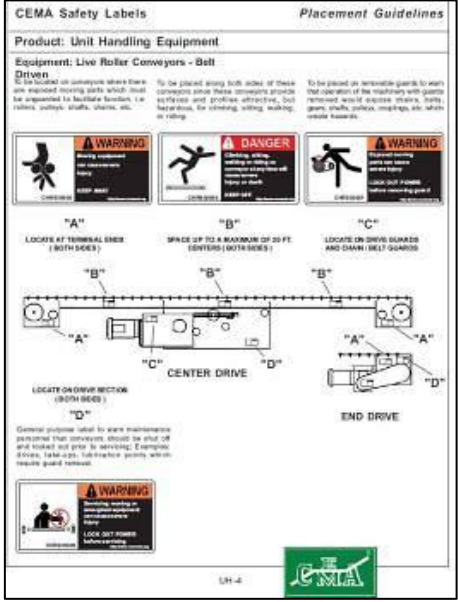

CEMA Safety Labels Placement Guidelines

Product: Unit Handling Equipment
Equipment: Live Roller Conveyors - Belt Driven

To be located on conveyors where there are exposed moving parts which must be safeguarded to facilitate function, i.e. rollers, pulleys, shafts, chains, etc.

To be placed along both sides of these conveyors since these conveyors provide surfaces and profiles attractive, but hazardous, for climbing, sitting, walking or riding.

To be placed on automatic guards to warn that operation of the machinery with guards removed is hazardous. Labels should be placed on the rollers, pulleys, shafts, chains, etc. when visible hazards.

"A"
LOCATE AT TERMINAL ENDS (BOTH SIDES)

"B"
SPACE UP TO A MAXIMUM OF 20 FT. CENTERS (BOTH SIDES)

"C"
LOCATE ON DRIVE GUARDS AND CHAIN/BELT GUARDS

LOCATE ON DRIVE SECTION (BOTH SIDES)

LOCATE ON DRIVE SECTION (BOTH SIDES)

LOCATE ON DRIVE SECTION (BOTH SIDES)

LOCATE ON DRIVE SECTION (BOTH SIDES)

General purpose label to warn maintenance personnel that conveyors should be shut off and locked and tagged for servicing. Examples: Drives, take-ups, idler/drive pulley which require guard removal.

UH-4

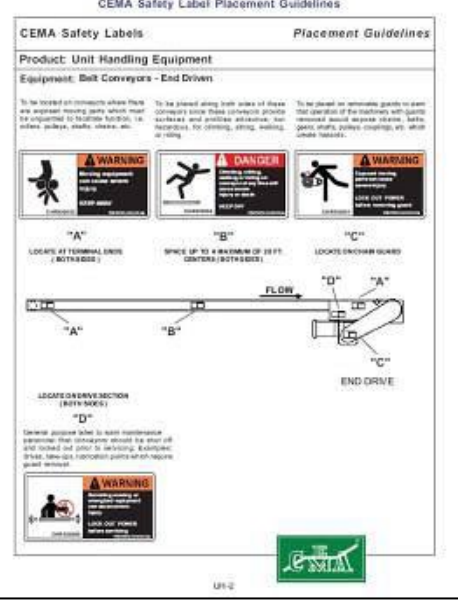

CEMA Safety Labels Placement Guidelines

Product: Unit Handling Equipment
Equipment: Belt Conveyors - End Driven

To be located on conveyors where there are exposed moving parts which must be safeguarded to facilitate function, i.e. rollers, pulleys, shafts, chains, etc.

To be placed along both sides of these conveyors since these conveyors provide surfaces and profiles attractive, but hazardous, for climbing, sitting, walking or riding.

To be placed on automatic guards to warn that operation of the machinery with guards removed is hazardous. Labels should be placed on the rollers, pulleys, shafts, chains, etc. when visible hazards.

"A"
LOCATE AT TERMINAL ENDS (BOTH SIDES)

"B"
SPACE UP TO A MAXIMUM OF 20 FT. CENTERS (BOTH SIDES)

"C"
LOCATE ON CHAIN GUARDS

LOCATE ON DRIVE SECTION (BOTH SIDES)

LOCATE ON DRIVE SECTION (BOTH SIDES)

LOCATE ON DRIVE SECTION (BOTH SIDES)

LOCATE ON DRIVE SECTION (BOTH SIDES)

General purpose label to warn maintenance personnel that conveyors should be shut off and locked and tagged for servicing. Examples: Drives, take-ups, idler/drive pulley which require guard removal.

UH-2

Reference <https://cemanet.org/> for safety label guidelines.

2.2 WARNINGS AND SAFETY INSTRUCTIONS

Failure to follow the instructions and cautions throughout this manual and warning label on the conveyor may result in injury to personnel or damage to the equipment.

Your MHS Conveyor is powered by a motor and can be stopped only by turning off electrical power to the motor. As with all powered machinery, the drive-related components – including sprockets, chains, shafts, universal joints, and pneumatic devices – can be dangerous. We have installed or provided guards to prevent accidental contact with these parts, along with warning labels to identify the hazards.

Special attention must be paid to the following areas of this manual:

 **DANGER**



- Indicates an imminently hazardous situation which, if not avoided, will result in death or serious injury. This signal word is to be limited to the most extreme situations.

 **WARNING**





- Indicates potentially hazardous situation which, if not avoided, could result in minor or moderate injury. It may also be used to alert against unsafe practices.

CAUTION

- Indicates a potentially hazardous situation which, if not avoided, may result in minor or moderate injury. It may also be used to alert against unsafe practices.

2.2.1 Warnings and Safety Instructions

 <h1 style="margin: 0;">WARNING</h1>	
	<ul style="list-style-type: none"> • After maintenance, REPLACE guards immediately. • Keep ALL warning labels clean and clear of any obstructions. • Never remove, deface, or paint over WARNING or CAUTION labels. Any damaged label will be replaced by MHS Conveyor at no cost by contacting Lifetime Services. • It is very important to instruct personnel in proper conveyor use including the location and function of all controls. • Special emphasis must be given to emergency stop procedures. • It is important to establish work procedures and access areas, which do not require any part of a person to be under the conveyor. • It should be required that long hair is covered by caps or hairnets. • Loose clothing, long hair, and jewelry must be kept away from moving equipment. • Maintain enough clearance on each side of all conveyor units for safe adjustment and maintenance of all components. • Provide crossovers or gates at sufficient intervals where needed to eliminate the temptation for personnel to climb over or under any conveyor. • Walking or riding on a moving conveyor must be prohibited. • Before performing maintenance on the conveyor, make sure the start-up controls are locked out and cannot be turned on by any person other than the one performing the maintenance. • If more than, one crewmember is working on the conveyor, EACH CREW MEMBER MUST HAVE A LOCK ON THE POWER LOCKOUT. • All pneumatic devices must be de-energized, and air removed to prevent accidental cycling of the device while performing general maintenance. • Make sure all personnel are clear of all conveyor equipment before restarting the system. • Before restarting a conveyor, which has been stopped because of an emergency, an inspection of the conveyor must be made, and the cause of the stoppage determined. The starting device must be locked out before any attempt is made to correct the cause of stoppage.

 **WARNING**



- Motor rollers can become hot!
- Workplace and traffic routes may require additional protections/guarding if nearby hazardous equipment.
- IntelliROL equipment starts and stops without warning.



- Employees that come in contact with the equipment must be warned of dangers of unexpected start. Hands can be crushed between products or products and channel.



- Before servicing or performing any work in the motor control panel, disconnect and lock out air and the main incoming service. If only the panel disconnect is off, the incoming side will still be hot.



Safety WARNING Label Lock Out Power

2.3 MHS CONVEYOR CONTROLS SAFETY GUIDELINES

The following basic conveyor control safety guidelines are recommended by MHS Conveyor even though Business Partner may or may not purchase conveyor controls from MHS Conveyor. The items listed deal with applications of controls equipment. The actual installation of the equipment must always follow the National Electric Code and all other local codes.

Start-up Warning Horn

Ideally, all conveyors should be within sight of the conveyor start pushbutton. This allows the operator to verify that no one is touching the conveyor or would be in danger if the conveyor were to start up.

If it is not possible to see the entire conveyor being started from the start pushbutton location, then some form of audible warning device is required. It could be a horn, buzzer, bell, or anything unique to that conveyor for that location. It should be loud enough to be heard at any point on the conveyor system. It should sound for approximately five seconds after the start pushbutton is pushed, prior to the actual running of conveyor. Any auxiliary equipment such as vertical lifts, turntables, etc., should also be included in the warning circuitry.

Conveyors that stop and restart under automatic control could also require a horn warning prior to restarting. If it is not easy to distinguish the difference between a fully stopped conveyor system and a momentarily stopped conveyor section, then it is advisable to add a warning horn. All conveyor sections that stop and restart automatically should be marked with appropriate signs or labels.

Start Pushbuttons

Start pushbuttons should be the flush type or guarded such that inadvertently leaning against them will not actuate the conveyor. They should be provided with a legend plate clearly defining which conveyors will be started.

Stop Pushbuttons

Stop pushbuttons should be the extended type such that any contact with it is sufficient to stop the conveyor. They would also be provided with a legend plate clearly defining which conveyors will be stopped.

Operator Controls

Additional operator controls should be designed into the system with the same guidelines that go into start and stop pushbuttons, depending upon their function. Devices which are repeated on multiple control stations, such as emergency stops, should be located at the same relative location on each station (such as lower right corner).

Emergency Stops

All locations where an operator must work directly at the conveyor should be protected by an emergency stop. An operator should not have to move from where he is to actuate the emergency stop.

Conveyors in areas of high pedestrian traffic should also be protected by emergency stop devices.

For all other instances, emergency stops should be located throughout a system such that it is possible to shut down the system without having to walk too far. In these instances, the emergency stop is used more to protect the equipment from damage than to protect personnel.

Emergency stops can be of the pushbutton or cable operated switch type. The pushbutton type should be a red, mushroom head maintained pushbutton which requires resetting after it is actuated. Cable operated switches should trip by pulling the cable and require resetting at the switch.

Actuating an emergency stop must drop-out the start circuit, requiring restarting the system using the start pushbuttons provided.

An emergency stop should normally stop all conveyors in the system. Very large systems may involve dividing a system into zones of control based on proximity of personnel, safety hazards, walls obstacles, etc.

Controls Logic

Solid state controls logic devices, such as programmable controllers are used extensively for conveyor control. They are very reliable, but a hardware failure or software bug would cause an output to function erratically. For this reason, start circuits, warning horn circuits, and emergency stops should usually be configured using conventional relay logic.

Safety Switches

All conveyor control cabinets and motors should be provided with safety (or disconnect) switches. These switches must have provisions for padlocking. As required for maintenance, equipment should be locked in the off position.

Special Devices

Special devices and equipment such as vertical lifts, turntables, high speed conveyors, etc., all have unique design and safety requirements. These should be looked at in each case to determine what the requirements might be.

Rev 08/12/2021

3 INTELLIROL INTRODUCTION

Concept

Utilizing 24V DC motorized roller, this technology is the most revolutionary since the advent of the line-shaft conveyor in the late- '60s. Its impact is currently expanding rapidly as more users and manufacturers begin to see the benefits of this technology. MHS Conveyor' experience with IntelliROL goes back to 1996 with a major tire handling system. This fast-advancing technology uses a self-contained 24-volt DC motorized roller to power a segment or zone of the conveyor. Rollers adjoining the motorized roller are slave-driven with the same components MHS Conveyor developed in the '60s.

XenoROL® line-shaft driven live rollers and IntelliROL equipment both drive product through the developed tangential force at the conveyor roller surface. The relationship between tangential forces, product weight and product characteristics have been at the root of MHS Conveyor technology for the past 30 years. This natural extension places MHS Conveyor at the forefront of applying this technology.

Operation

The product-carrying rollers are slave-driven by a series of pre-tensioned belts to the motorized roller in each zone. Since every motorized roller can be individually controlled, every segment of the system can become a zero-pressure zone.

Accumulation begins when an external signal “arms” the first sensor (discharge end). External signals may originate from electrical controls, sensing devices, manually activated switches, etc. The first product stops at the discharge sensor, which arms the sensor in the upstream zone. A product travels through a zone, until blocking, the sensor (Armed from the previous zone) all carrier rollers within the zone stop. As accumulation takes place from zone-to-zone, accumulated products do not touch each other as long as the product is shorter than the zone length.

Feature/Benefits

Features	Benefits
Flexible Modular design	Easy to reconfigure
Run on demand	Less noise, wear, and energy consumption
Non-contact zero-pressure	Product protection
Compact low profile	Multi-level usage
Reversible	Less electrical hardware cost
No scheduled maintenance	Lower operating cost
Low voltage	Safety and lower cost
Simple installation	Lower cost
Soft start/stop	Low G-forces
Variable speed	Versatility to suit each requirement
Intelligent control capabilities	Cost no greater than need

Most IntelliROL modules have a maximum depth profile of 6-3/8" top of roller (TOR) to bottom of flange. Devices such as UBT, Wheel Diverters, etc. Require a deeper channel profile. A bi-directional urethane belt transfer has a **maximum** rate of 30 cases per minute.

CAUTION
<ul style="list-style-type: none"> • Urethane belt transfer, belts should only run while transferring a load. (<u>Run on Demand</u>)

All curves except the minimum radius curve are based on MHS Conveyor’ true taper roller for all widths.

IntelliROL optional run-on-demand software can selectively deactivate conveyor zones when not carrying product. Because each IntelliROL module has its own drive and control, any level of control sophistication is possible, including product tracking, diagnostics, and data collection.

The technology behind IntelliROL is growing and changing quickly. Most applications use a 24-volt DC, 1.9" diameter, brushless motorized roller, and these rollers are the basis of design for most IntelliROL modules. Special applications requiring slow speeds and high torque may require the use of geared motorized rollers and 3-phase AC voltage motorized rollers have been used in heavy-duty applications.

3.1 INTELLIROL APPLICATION OPTIONS

The application of IntelliROL breaks down into two areas. One is complete systems; the other is the application of specific modules within a system that may be based on line-shaft or some other conveyor technology.

MHS Conveyor has standard designs for straight bed sections for transportation or zoned accumulation. Standard zone lengths are 24" or 30". MHS Conveyor also offers curves in 30, 45, 60 and 90 degree, 30 or 45 degree spurs, UBT transfers, three designs of product stops, belted inclines and declines, gates, minimum radius curve, and anti-rollback brakes (inclining). Many options are available including different roller centers, bearings, roller coatings, etc.

Application Specific Modules may be used to solve certain requirements within a system at a most cost-effective manner using IntelliROL conveyor.

Application Specific Module examples include:

- Short spurs
- Workstations
- Fill gaps between conveyors or devices
- Providing power to a lift bed
- Transfer car
- The bed of a turntable
- Gates
- Low Profile requirements over aisles, multi-level, etc.

In nearly all the above examples, space is a major consideration. Weight and balance may even be a consideration on something like a scale, lift, or vertical conveyor.

3.2 DEFINITION OF TERMS

Accumulation - Act of queuing, holding, or backing up of product on a conveyor.

Carrying Roller - The conveyor roller upon which the object being transported is supported. It has circumferential grooves near one end to allow the slave belts to ride below the carrying surface.

Coefficient of Friction - A numerical expression of the ratio between the force of contact between two surfaces and the resistant force tending to oppose the motion of one with respect to the other.

Conveyor Width - The dimension outside to outside of frame rails. For the inside dimension, the abbreviation "BF" (between frames) is used.

Crossmember - Structural member, which is assembled between two sides, channels of a conveyor bed.

Frame - The structure, which supports the components of a conveyor bed consisting of formed channel rails, bolted together with crossmembers.

Indexing Control - Maintains non-contact accumulation and functionality of gates, transfers, curves, etc. by not allowing accumulation in these areas.

IntelliROL Non-Contact Accumulation - "Pure" zero-pressure accumulation which guarantees that one product will not touch any other during accumulation, release, or any time. (Requires product to be inducted singularly and be 3" to 4-1/2" shorter than zone).

Roller Centers - Distance between centerlines of adjacent rollers. For curves, roller centers are measured at the inside radius.

Roller Groove - The groove that is fabricated into the carrying roller to provide a seat for the slave belt below the carrying surface.

Singulation Release - A method of individual zone release that spaces product approximately one zone length apart.

Slave Belt - An endless round belt manufactured from elastic material, typically urethane, connecting a motorized roller, or carrying rollers or other carrying rollers within a zone.

Slug Release - Simultaneous release of several products.

Tapered Roller - A conical conveyor roller for use in a curve with end and intermediate diameters proportional to their radius.

Zone - A portion of conveyor activated by a motorized roller that may be controlled by a photoeye.

Zone Length - The distance between sensing devices (typically containing one motorized roller).

Zero-Pressure Accumulation - The lack of force between products after accumulation. (Industry standard)

4 INTELLIROL RECEIVING & SITE PREPARATION

General

MHS Conveyor IntelliROL units are shipped in subassemblies. These subassemblies are packaged to guard against damage in shipment, when handled properly.

Examination immediately following unloading will show if any damage was caused during shipment. If damage is evident, claims for recovery of expenses to repair damage or replace components must be made against the carrier immediately. While unloading, a check must be made against the Bill of Lading, or other packing lists provided, to confirm full receipt of listed items.

CAUTION

- **TAKE CARE DURING THE REMOVAL OF EQUIPMENT FROM THE CARRIER.** Remove small items and boxes first. Pull and lift only on the skid, not on the frame, cross member or any part of the equipment.



Preparation of Site

After the conveyor is received, move it to the installation site or designated dry storage area as soon as possible. Clean up all packing material immediately before parts get lost in it. Loose parts should remain in the shipping boxes until needed.

Prior to starting assembly of the conveyor, carefully check the installation path to be sure there are no obstructions that will cause interference. Check for access along the path needed to bring in bed sections and components closest to the point where they are needed. It is often necessary to give the area along the system path a general cleanup to improve installation efficiency, access, and accuracy.

4.1 PARTS INVENTORY & IDENTIFICATION

Each subassembly is shipped completely assembled. Identify and separate components by type or tag number, for inventory and ease of locating during installation.

An identification label is attached to the outside of one side channel or on a cross member, close to one end of each conveyor bed.



This label contains:

- Item number
- Description
- Job Number
- Mfg. Number
- Date of manufacture
- Tag number (if specified)
- Assembler's clock number
- QR (Quick Response) Label
 - Scan Code for IOM Manual





Scan the QR code to retrieve the IOM Manual, if nothing happens; check your scanner settings and make sure the QR Label setting is enabled.

On the supports, the tag is located on the bottom side of the foot. On special devices, it is located on a convenient flat surface that is not offensive to the appearance of the equipment but is still accessible for viewing. These numbers can be cross-referenced against the packing list. Loose parts are boxed and shipped separately.

You should have all conveyor sections and supports for a particular conveyor prior to installation. It is cost-effective to identify and procure any missing parts before they are needed for assembly. Small items like nuts and bolts are weigh-counted and packaged by size and type.

WARNING	
	<ul style="list-style-type: none"> • The Installation Supervisor must be experienced with conveyor, qualified in the mechanics of the equipment, and enforce safe working procedures for the protection of the crew, customer, and customer's property.

 WARNING	
	<ul style="list-style-type: none">• Before restarting a conveyor which has been stopped because of an emergency, an inspection of the conveyor must be made and the cause of the stoppage determined. The starting device must be locked out before any attempt is made to correct the cause of stoppage.

5 INTELLIROL INSTALLATION

General

IntelliROL conveyors are offered in four standard widths of 16BF, 22BF, 28BF, and 34BF with the overall conveyor width being 3.25" plus the BF. Standard available bed lengths are multiples of the two standard zone lengths of 24" and 30", up to 10' (both) or 12' (24" zones only). Standard roller center distance is 3". Other roller centers and widths may be available.

Driver Cards

The driver cards that are supplied with each motorized roller are mounted inside the side channel of a bed, opposite the slave O-ring side of the conveyor. These driver cards condition the 24VDC power coming from a separate power supply. Standard IntelliROL beds are prewired and tested prior to shipping. MHS Conveyor provides an optional plastic shroud that snaps into grooves in the 7.5" deep CRUZchannel to cover the driver cards and wiring. These shrouds are translucent to allow monitoring of the LED condition lights on the driver cards.

Shrouds

Translucent PVC shrouds are available in 5' lengths to enclose the CRUZchannel or C6-channel to cover and protect the CRUZcontrol® components. Mounting brackets for the C6 shrouds are installed in the field. Shrouds and mounting kits are shipped loose for field installation.

Field modification is required to the shrouds if they are used with adjustable channel guardrail. Optional jackets mounted to bottom flange of conveyor can be used as an alternate mount.

Note:

When installing conveyor shrouds, every fourth shroud requires safety label information and in addition, every 4th or 5th section requires a MHS Conveyor label. Alternate labels so they are not on the same shroud.

Drive / Slave Belt Break-in

The roller-to-roller round drive belts are installed under tension with predetermined initial tension. After a time of static and running time, this initial tension drops to a running tension.

Commissioning of Equipment

Commissioning of the equipment can best be defined as the final adjustments and test of the installed equipment required for its proper operation. The need for commissioning is inherent, since the individual components of equipment are brought together at the installation site to operate as a system.

Mechanical and electrical commissioning is most often carried out simultaneously. Commissioning must simulate the actual operation of the system as close as possible to demonstrate its ability to perform reliably at the specified rate in the prescribed operational sequence.

During the Commissioning Phase, it is necessary to load the equipment with product to be conveyed, which provides the means of detecting those areas requiring adjustment. Personnel will be required to support operational functions and may serve as part of operator training and familiarity with the system. During the commissioning activity, special attention should be directed toward personnel safety.

No unnecessary risks should be taken that would endanger the safety of any commissioning personnel. All personnel must familiarize themselves with all safety features of the system such as emergency stops and power supply disconnects.

After commissioning, conduct operator training on all safety and operational aspects of the system. This must include systems start-up, location of emergency stops, and familiarity with all operator controls.

5.1 ENVIRONMENT

Precautions

ULTRAVIOLET RAYS of sunlight will weaken polyurethane slave belts.

OILY OR WET CONDITIONS impair frictional drive characteristics between polyurethane slave belts and roller grooves.

CORROSIVE SUBSTANCES, such as concrete curing agents will adversely affect various components, voiding the warranty.

Temperature range (ambient):

+35° to +100° F. For applications that exceed this temperature range, please consult Applications Engineering.

Grounding:

Equipment should be properly grounded before operation

Cleaning O-Rings

Manufacturer suggested for cleaning O-rings is to use a cloth with a de-natured alcohol when cleaning the O-ring. This cleaning product would also work for cleaning the rollers.

Note:

Do NOT immerse the O-rings or any component in a container of this cleaning product.

5.2 SUPPORTS & CONNECTIONS

Roll Formed (RF) supports replace all existing MHS Conveyor floor supports.

For details on Supports & Connections, see Support & Connections (IOM# 1200485) at: mhs-conveyor.com

5.3 GAP FILLER BED

Application

- The application of Gap Filler Beds is for transportation conveyor.
- When using a Gap Filler Bed between two transportation conveyors, use a roller spacing the same as the beds adjacent to the filler bed.

Features/Benefits

Gap Filler Beds aid the modularity of conveyors. Filler beds fit between straight sections of transportation to add length to the conveyor layout. The following is a list features and their benefit.

- Modular design - Easy to reconfigure.
- C6 and CRUZ channel beds available in both 2” and 3” roller spacing.
- No scheduled maintenance - Lower operating cost.
- Simple installation - Lower cost.
- Few moving parts -Reduced maintenance cost and less noise.

5.4 DIMENSIONAL REFERENCE POINTS

The path of each conveyor in the system is determined by establishing a reference point at each end. The centerline of the conveyor is established and a chalk line is snapped between these points.

Conveyors should be installed with the centerline of the bed matching the centerline of the conveyor path within 1/8" of true center. Locate and mark the center of the crossmembers at each end of the conveyor. Use a plumb line or other acceptable means to ensure accuracy to the chalk line.

Always carry out a thorough check for any obstructions such as building columns, manholes, etc. It may be necessary to reroute the conveyor to avoid the obstruction. In this case it would be advisable to begin installation at this point, using the obstruction as a reference point (Datum), and install the sections in either direction as required.

All conveyor sections must be checked for squareness prior to installation as "racking" or being knocked out of square may have occurred during shipping and handling.

5.5 INTELLIROL INSTALLATION

Basics IntelliROL Installation

IntelliROL conveyor may be installed using any of the supporting arrangements described under Support & Connections chapter of this manual. As each bed is installed in the system, level the conveyor from side to side using a bubble level on the roller at each support. The bubble location should be within the level indicator lines of the level. The centerline of the conveyor should not bow to the right or left more than 1/8" in either direction from a centerline drawn between the centers of the conveyor end assemblies.

A simple way to check this is to tie a nylon string around the center of the end roller, pull it taut, and tie it to the center of the roller at the opposite end. Put a wood spacer under the string at each end so it does not rest on the rollers. With the taut string centered on each end and suspended above the rollers, check the center of the rollers at each support relative to the string and adjust accordingly. (Note that this must be done after side-to-side leveling of the conveyor at each support.)

When joining bed frames it is important to align the side channels. Care must be taken to make sure the rollers are level (carrying surfaces) from bed to bed.

All bed frames should be checked for squareness. To check, measure diagonally from corner to corner. Measure the opposite corners in the same manner. If the bed is square, the two measurements will be the same within 1/16".

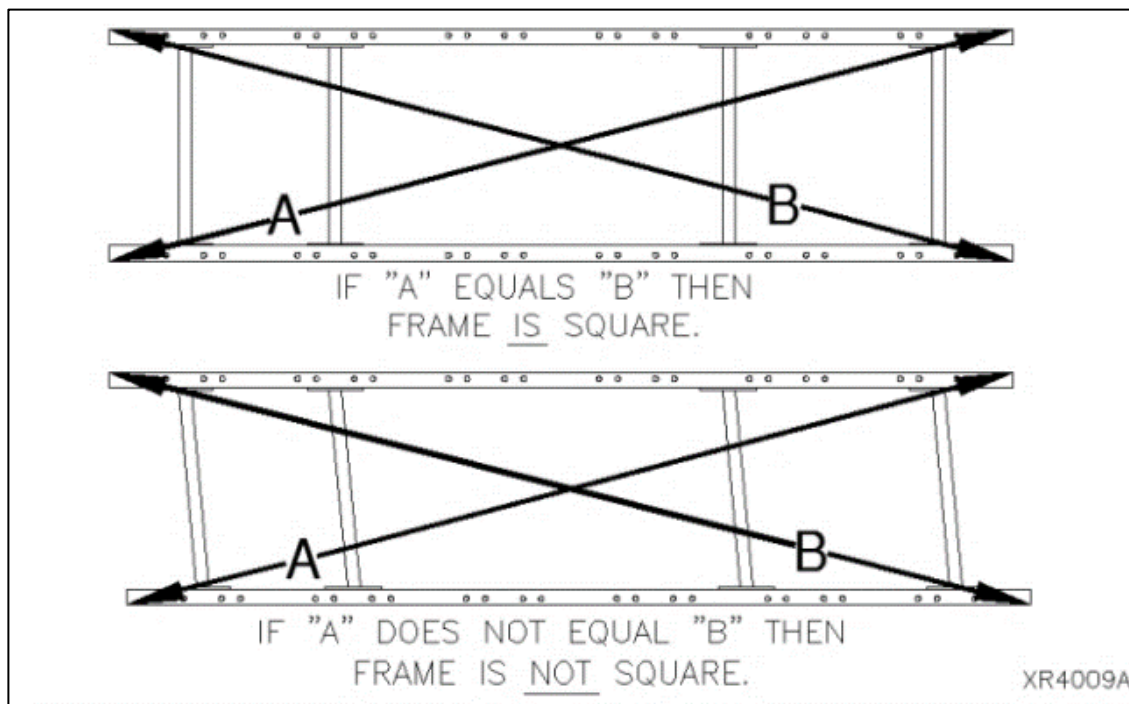

5.6 ELEVATIONS

All conveyors should be installed in accordance with the elevations shown on the drawings. In addition, all conveyors must be level across the frame width and length (if horizontal). Leveling of the frames is best done using a rotating laser level or a builder's level.

After the first elevation is established at a critical point, the elevation of all other points shall be relative to this first point. Normal practice is to dimension the layout and measure elevations from the floor at each point of support.

As the conveyor system proceeds onto another floor or into another building or room, a new elevation will be measured from the floor at that point. This new elevation will then become the reference for subsequent elevations.

When installing an overhead system

The first elevation is measured from the floor and becomes the reference elevation point until a change in elevation is shown on the layout. Any new elevation is also measured from the floor and becomes the new reference point. The process is repeated each time an elevation change occurs.

CAUTION

- Consult the building architect or a structural engineer regarding ceiling loading or structural limitations of the building if any conveyor section is ceiling hung.

Component Orientation

Using your conveyor system layout drawing and the numbers on the I.D. tags on each component, position and align the conveyor sections, you must know:

- The direction of product flow
- The elevation height
- Charge and discharge end beds

IMPORTANT!

Do not make alterations to the equipment without consulting with user's representative and MHS Conveyor. Unauthorized modifications to the equipment may impair its function, create a hazardous condition, affect its useful life, and/or void the warranty.



Establishing Conveyor Flow

Standard IntelliROL beds are supplied as either RH or LH flow. Looking across from the side of the IntelliROL bed the O-rings away from you and the product conveying to the right, the bed is considered a

right hand (RH) flow bed. Using the same position as noted above and with the product conveying to the left, the bed is considered a left hand (LH) flow bed. The identification label described under [Parts Inventory & Identification](#) has all of the information required to identify the piece of equipment.

6 INTELLIROL APPLICATIONS

6.1 ITR APPLICATION STANDARD

The ITR product line is based on the following features and concepts: <http://itohdenki.com/>

- Itoh Denki motorized rollers and drivercards (CBM-105, HB-510 or IB-E03) are standard.
- Cables are pre-engineered with the appropriate connectors.
- All channels are designed to accommodate any of the electrical variations.
- All CRUZchannels including C6 channels have welded connectors and CRUZbelt tube crossmembers.
- AutoCAD blocks for ITR devices are available upon request.

6.2 ITR – CBM-105 (TRANSPORTATION)

- Standard product offered in Core Technologies.
- Transportation conveyor based on the Itoh CBM-105 drivercard and FE-60 motorized roller.
- Each drivercard is wired to power but requires a 24VDC run signal (provided by others) to run each card. Beds include a run harness distributing that signal to each card.
- C6 channel with welded butt bolt bed connectors.
- 30” roller groups with 3” centers are standard.

6.3 ITR – HB-510 (ACCUMULATION)

- Standard product offered in Core Technologies.
- ZPA conveyor based on the Itoh HB-510 drivercard and FE-60 motorized roller.
- Can be a standalone conveyor. It may not require an input from a control panel depending on application.
- CRUZ channel with welded butt bolt bed connectors and integrated photoeyes.
- 24” and 30” zones with 3” centers are standard.
- A start signal can be used to activate the conveyor when using run on demand.

6.4 ITR – IB-E03 (PROGRAMMABLE)

- Standard product offered in Core Technologies.
- Conveyor based on the Itoh IB-E03 drivercard and FE-60 motorized roller.
- Programmable drivercard (Programming by customer).
- CRUZchannel with welded butt bolt bed connectors and integrated photoeyes.
- Accumulation or transportation depending on customer needs.
- A signal can be sent from central PLC to activate the conveyor through the cards LAN line or the card can activate the conveyor with internal programming logic using the cards inputs.

6.5 ITR BED CONSTRUCTION

- Straight bed, curve, & spur channels – CZ or C6.
- C6 channel standard has 1.625” flanges.
- C6 channel top flange are punched at ends for transition bezel (1120166) from C6 to CRUZchannel.
- All channels come with a welded bed connector.
- Straight bed crossmembers are tube style as used in the CRUZbelt product line.
- Straight beds will be punched for drivercards in every zone.

6.6 ITR FULL WIDTH BELT BED CONSTRUCTION

- Horizontal, Decline, Incline, Noseover and Noseunder Beds
- Standard driver card for accumulation.
- ZPA conveyor based on the Itoh HB-510 or IB-E03 driver card and FE-60 motorized roller.
- Can be a stand-alone conveyor. It does not require an input from a control panel, etc. to operate.
- CRUZ®channel with welded butt bolt bed connectors and integrated photoeyes.
- 24" and 30" zones
- A start signal can be used to activate the conveyor when using run on demand.
- Each driver card is wired to power using a power harness with a male connector at the charge end and a female connector at the discharge end.

6.7 ITR SKEW BED CONSTRUCTION

- Straight bed – CRUZ®channel.
- CZ channel standard has 1.625” flanges.
- 2.25"RC installed at the factory.
- Transportation conveyor based on the Itoh CBM-105 cards and FE-60 motorized roller.
- All channels come with a welded bed connector.

6.8 CURVE CONSTRUCTION

- 36” standard inside curve radius with CRUZ® side channel.
- Curve channels are notched with welded 10ga backers.
- No straight tangents, full straight section arc only.
- All channels come with a welded bed connector.
- CBM-105, HB-510, and / or IB-E03 cards located on the outer channel with an adapter plate (CBM-105 Plate: E0006531, HB-510 Plate: E0006532, IB-E03 Plate: 1165192).
- Sensor location is 6” from the end of the zone.

6.9 UBT PNEUMATIC CONSTRUCTION

- 3'-4" OAL standard for 6 strand, 3'0" standard for 5 strand.
- C6 channels are 10ga construction with welded butt bolt bed connectors.
- UBT transfers use 1.9" diameter carrier rollers.
- UBT transfer belts on 4" center standard.
- UBT's with sensors, PE's (ZL) & reflectors are available as a standard option.
- UBT's are universal LH/RH. The power harness is installed for LH flow, but can be reversed by moving a female gender adapter to the other end of the harness.

6.10 UBT ELECTRIC CONSTRUCTION

- 3'-4" OAL standard for 6 strand, 3'0" standard for 5 strand.
- C6 channels are 10ga construction with welded butt bolt bed connectors.
- UBT transfers require 1.9" diameter carrier rollers.
- UBT transfer belts on 4" center standard.
- UBT's with sensors, PE's (ZL) & reflectors are available as a standard option.
- UBT's are universal LH/RH. The power harness is installed for LH flow, but can be repowered by moving a female gender adapter to the other end of the harness.
- ITR_{IBE} is the only version of a standard electric lift UBT (transportation only).
- (2) 24VDC Lifting Gearmotors standard.

6.11 MERGE BEDS

- Single bed that does not come with a spur bed, but is designed to have a spur mounted to it.
- **Must use** designated bracket kit. MHS Conveyor P/N: 1208351
- Merge is available in ITRCB or IB-E03 version.
- Works with standard spur beds. Spur beds are 30 & 45 degree, RH/LH.
- PE's by others.

6.12 POWER MERGE CONSTRUCTION

- Standard power merge is available in ITRCB or IB-E03 version (Transportation only).
- Standard spur angles are 30 & 45 degree, RH/LH.
- Spur BF is 6" wider than abutting bed.
- PE's by others.

6.13 WHEEL DIVERT PNEUMATIC CONSTRUCTION

- Standard wheel diverter available in ITRCB or IB-E03 version (Transportation only).
- Standard spur angle is 30 degree RH/LH beds.
- Standard diverter has 4 wheel rows divided into two groups. Two solenoids standard, each solenoid operates two rows.
- Optional:
 - Diverter has 4 independently acting rows. Each divert wheel row is controlled by a separate solenoid. Having separate solenoids allows for independent control to raise or lower each wheel row independently allowing increased throughput.
- Solenoids are included as standard. 120VAC or 24VDC available.
- PE's by others.
- Wheel diverts include drop out tubs. Maintain at least 10" clearance below divert for removal.

6.14 WHEEL DIVERT ELECTRIC CONSTRUCTION

- ITR_{IBE} is the only version of a standard electric lift wheel diverter (transportation only).
- Standard spur angle is 30 degree RH/LH beds.
- Diverter has 4 acting rows. (2) Divert wheel rows are controlled by separate 24VDC Gearmotors.
- (2) 24VDC Lifting Gearmotors standard.
- PE's by others.
- Wheel diverts include drop out tubs. Maintain at least 10" clearance below divert for removal.

6.15 SPUR CONSTRUCTION

- Standard spur available in ITRCB or IB-E03 version (Transportation only).
- Standard spur angles are created for 30 & 45 degree, RH/LH.
- Each spur has a conversion cable to allow for proper power and control signal flow.
- Each spur includes a wheeled guardrail to direct packages.

6.16 ITR GATE

- Standard driver card for transportation.
- Transportation conveyor based on the Itoh CBM-105 and IB-E03 driver card and FE-60 motorized roller.
- Each driver card is wired to power using a power harness with a male connector at the charge end and a female connector at the discharge end.
- C6 channel with welded bed connectors.
- 30" roller groups.
- ITR CB or IBE Electrical Components
- A limit switch is included with the gate.

7 DESCRIPTION OF OPERATION

7.1 INTELLIROL ELECTRIC UBT (URETHANE BELT TRANSFER)

Note: Ref I/O chart below (dwg 130E263), description of operation based on default LH flow.

4DCM I/O			
OUTPUTS	DESCRIPTIONS	INPUTS	DESCRIPTION
MOTOR A	MOTOR A4 - LIFT	0-10V INPUT	
		SENSOR OUT	
		SPEED OUT	
		ERROR OUT	
		REVERSE	
		RUN	RUN SIGNAL LIFT
		COMMON	
3DCM I/O			
OUTPUTS	DESCRIPTIONS	INPUTS	DESCRIPTION
MOTOR A	MOTOR 3A - LIFT	0 - 10V INPUT	
		SENSOR OUT	
		SPEED OUT	
		ERROR OUT	
		REVERSE	
		RUN	RUN SIGNAL LIFT
		COMMON	
2DCM I/O			
OUTPUTS	DESCRIPTIONS	INPUTS	DESCRIPTION
MOTOR A	MOTOR 2A - ROLLERS	SENSOR A - SEN	
MOTOR B		SENSOR A - ALM	
OUT 1		SENSOR B - SEN	RAISE
OUT 2		SENSOR B - ALM	LOWER
OUT 3		IN 1	
OUT 4		IN 2	
OUT 5		IN 3	
1DCM I/O			
OUTPUTS	DESCRIPTIONS	INPUTS	DESCRIPTION
MOTOR A	MOTOR 1A - BELTS	SENSOR A - SEN	PRE - 3
MOTOR B	MOTOR 1B - BELTS	SENSOR A - ALM	PRE - 4
OUT 1	RUN SIGNAL - LIFT	SENSOR B - SEN	PRE - 1
OUT 2		SENSOR B - ALM	PRE - 2
OUT 3		IN 1	
OUT 4		IN 2	
OUT 5		IN 3	

When the system is first started, the following conditions should exist:

- Upstream conveyor running
- Downstream conveyors running
- UBT transfer rollers running (Motor 2A)
- UBT transfer in down position (Prox Lower)

As packages travel along the upstream conveyor, the PLC programming is used to determine what to do with each package at the decision point of the UBT. Specifically, the decisions needed at the UBT are as follows:

- Whether or not to divert the package.
- If the package is to be transferred, which direction to divert the package.

Once the package has completely entered the transfer, and needs to be diverted, as detected by PE-1 sensing the trailing edge of the package, a specified delay will turn off motor 2A. If the package is to be diverted two things will occur:

1. Motor 3A and 4A will raise the transfer, Prox Raise when detected will stop transfer in the raised position.
2. Motor 1A and 1B will run the transfer belts in the required divert direction.

If the package is diverted right, when the trailing edge of the package leaves the UBT and is detected by PE-4, Motors 1A and 1B will shut down, motor 2A will start the UBT rollers, and motor 3A and 4A will lower the transfer, Prox Lower when detected will stop the transfer in the lowered position.

If the package is diverted left, when the trailing edge of the package is detected by PE-2, Motors 1A and 1B will shut down, motor 2A will start the UBT rollers, and motor 3A and 4A will lower the transfer, Prox Lower when detected will stop the transfer in the lowered position.

If the package is to be passed through the UBT, Motor 2A will continue to run. When the trailing edge of the package is detected by PE-3 the unit is ready to receive another package.

Again, these decisions are based upon the data associated with the position of the package in the system or the barcode on the package.

If desired, if the UBT does not sense any product for a period of time, the system can be stopped. When product begins entering the UBT, as detected by PE-1, the system can be restarted and function as described above.

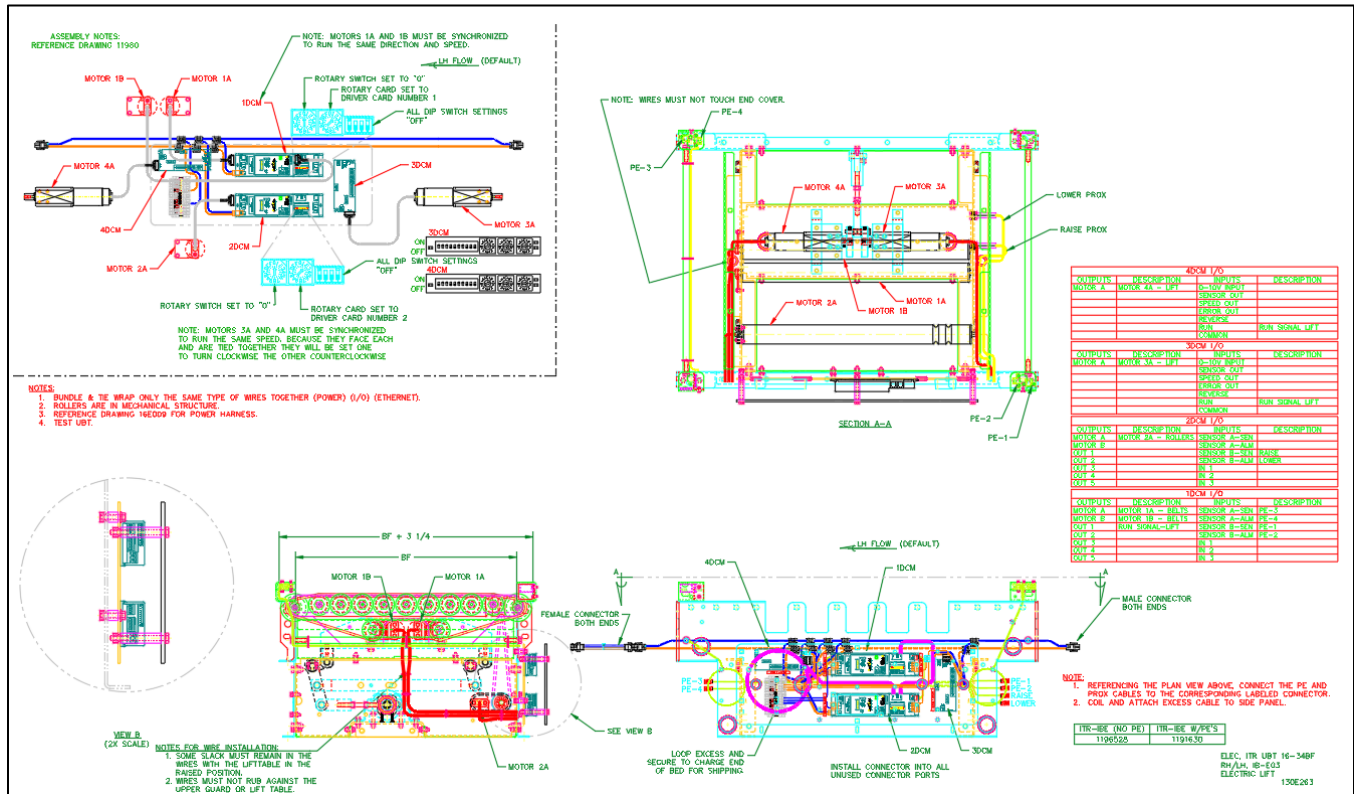

Reference drawing 130E263

7.2 INTELLIROL ELECTRIC WHEEL DIVERTER

Note: Ref I/O chart below (dwg 130E376).

INPUTS				
DEVICE TAG	CARD#	TERMINAL	DESCRIPTION	WIRED AT:
100PX	4	ALM A	WHEEL DIVERT ROW 1 & 2 LOWERED	BENCH
101PX	4	IN 1	WHEEL DIVERT ROW 1 & 2 RAISED	BENCH
102PX	4	IN 2	WHEEL DIVERT ROW 1 & 2 LOWERED	BENCH
103PX	4	IN 3	WHEEL DIVERT ROW 1 & 2 RAISED	BENCH
	4	SEN A	OPEN	
	4	ALM B	OPEN	
	4	SEN B	OPEN	
OUTPUTS				
DEVICE TAG	CARD#	TERMINAL	DESCRIPTION	WIRED AT:
000M	4	OUT 1	WHEEL LIFT MOTOR ROW 1 & 2	BENCH
001M	4	OUT 2	WHEEL LIFT MOTOR ROW 3 & 4	BENCH
	4	OUT 3	OPEN	
	4	OUT 4	OPEN	
	4	OUT 5	OPEN	

When the system is first started, the following conditions should exist:

16BF and 22BF Units	28BF and 34BF Units
Upstream induct conveyor running	Upstream induct conveyor running
Downstream conveyor running (Motor 3A)	Downstream conveyor running (Motor 3A & 3B)
Spur rollers running (Motors 1A & 1B)	Spur rollers running (Motors 1A, 1B & 2A)
Wheel diverter rollers running (Motors 4A & 4B)	Wheel diverter rollers running (Motors 4A & 4B)
Wheel divert in down position (I00PX & I02PX)	Wheel divert in down position (I00PX & I02PX)

As packages travel along the upstream conveyor, the PLC programming is used to determine what to do with each package at the decision point of the wheel diverter.

Specifically, the decision needed at the wheel diverter is:

- Whether or not to divert the package

As the next package upstream is about to enter the diverter area, all motors from the chart above will continue to run. If the package is to be diverted, the following will occur:

3. All motors will continue to run.
4. 000M and 001M will raise the transfer wheels, I01PX & I03PX when detected will stop the transfer wheels in the raised position.
5. The package will divert on to the spur.

Once the package is present on the spur bed, the following will occur:

1. All motors will continue to run.
2. 000M and 001M will lower the transfer wheels, I00PX & I02PX when detected will stop the transfer wheels in the lowered position.

As the next package upstream is about to enter the diverter area, and the package does not need to be diverted, the following will occur:

1. All motors continue to run, and the diverter will stay in the lowered position.

Again, these decisions are based upon the data associated with the position of the package in the system or the barcode on the package.

Note:

The electric lift wheel diverter is not intended to be left in the raised position for prolonged periods of time. It is intended to raise only as needed then returned to the lowered position when the package is cleared.

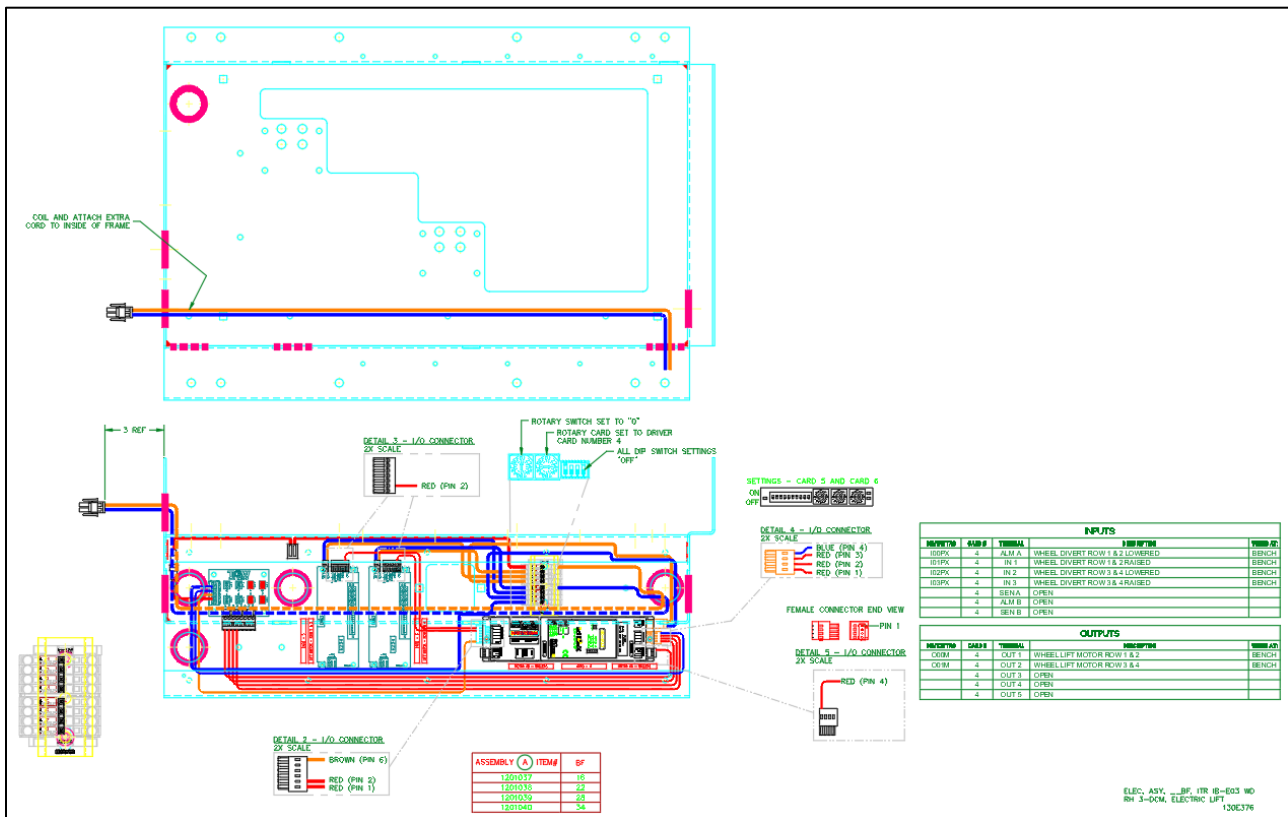

Reference drawing 130E376

8 ITR SKEWING BED ROLLERS

Skewing rollers is recommended on ITR conveyor if the between frame (BF) dimension of conveyor is double the width of the smallest product. The normal method of skewing is to install a factory skew bed at the charge end of your conveyor. If your conveyor line is over 100' long and you have small product on it, you may want to add a shorter maintenance skew bed midway down the conveyor to preserve the product alignment.

8.1 FACTORY SKEW SECTION

Standard 12', 10', or 5' skew beds are available with factory skewed rollers at 7 degrees. These beds are available in left or right hand and a factory installed wheel guard rail is standard. The skewed bed will move products across the conveyor approximately 16" over the 12' length. This side movement is dependent on the bottom condition of the product.

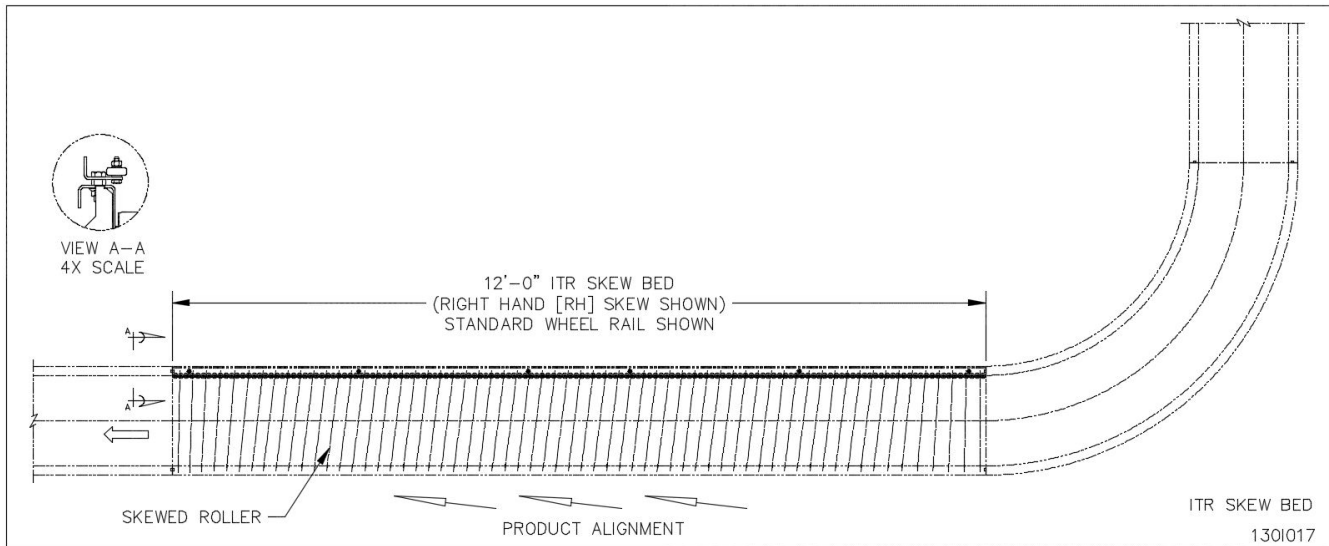

8.2 SKEW BED INSTALLATION

MHS Conveyor dedicated skew beds are typically installed as the first bed section in an ITR conveyor line starting from the charge end. The rollers are factory skewed to the requested side and the installation is the same as any other ITR transportation bed section.

A wheeled guard rail is standard to prevent the stalling of product as it is forced against the side channel by the skewed rollers. The wheeled rail is shipped installed at our factory.

9 ITR GATE

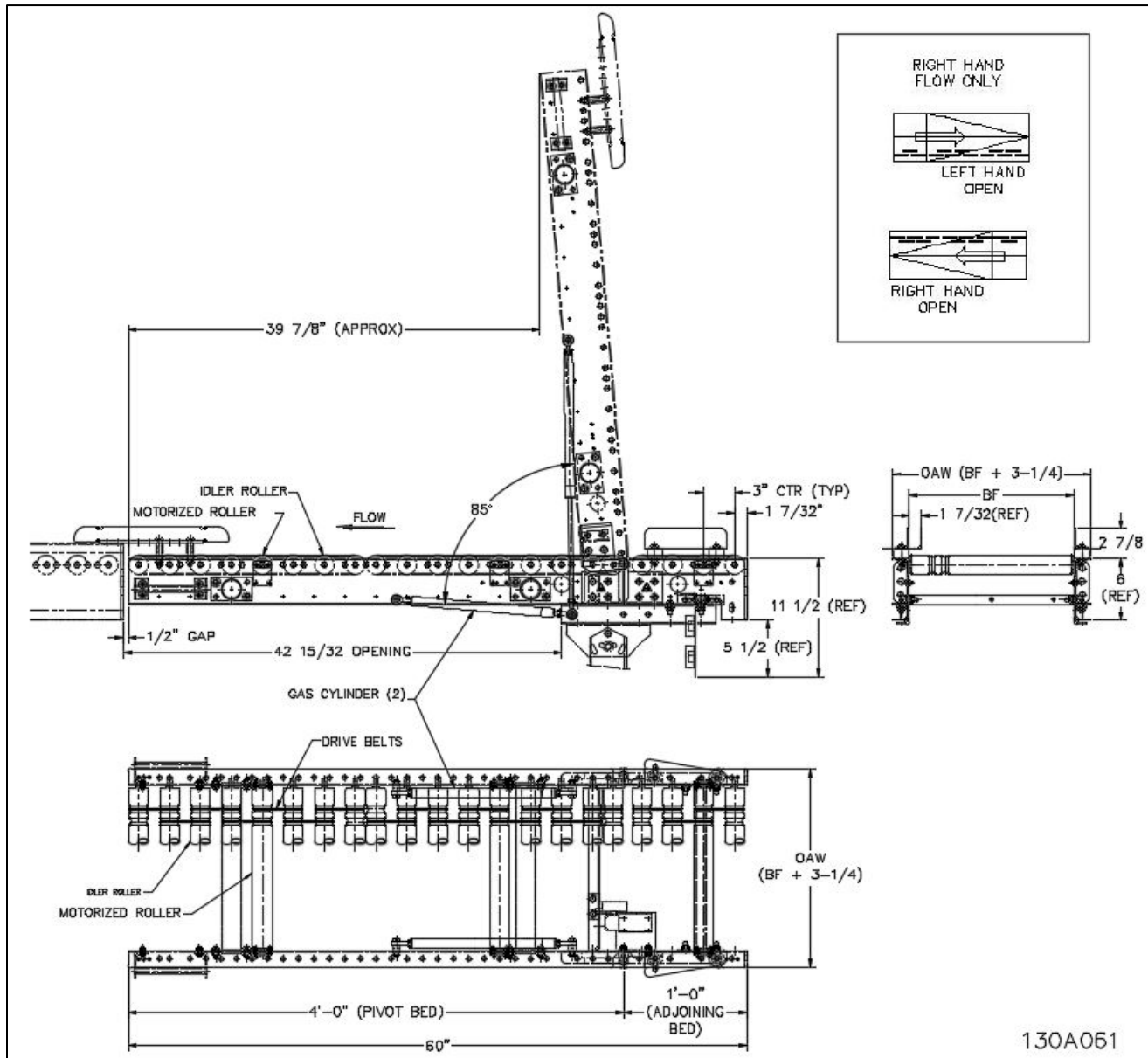

130A061

The gate provides a break in the conveyor line for pedestrian traffic. The power source must be from the charge side. The gate consists of a 4' pivoting bed and a 1' adjoining bed. Gates are available in right hand and left-hand lifts.

The gate requires a 1/2" gap between the discharge end of the lift gate section and the downstream conveyor for clearance.

9.1 LIFT GATE MAXIMUM CYCLES:

Zones are not used in the gate in an accumulation system. When a gate is used in transportation, controls must be in place to stop product when the gate is in the “up” position. The gate must be free of product before rising for pedestrian use. The conveyor **must stop** when the gate is open.

The lift gate operates with two gas springs that are used for counterbalance when the gate is raised and lowered. The gas springs are attached to inside of each gate side channel.

The powered lift gate is used for limited access to the opposite side of the conveyor. The lift gate is rated for a maximum of (5) cycles per 8 hour shift or 125 cycles over a (7) day period.

Exceeding the maximum cycles as stated above will cause damage to the gas springs and gate which will void the warranty.

10 INTELLIROL AIR SUPPLY REQUIREMENTS

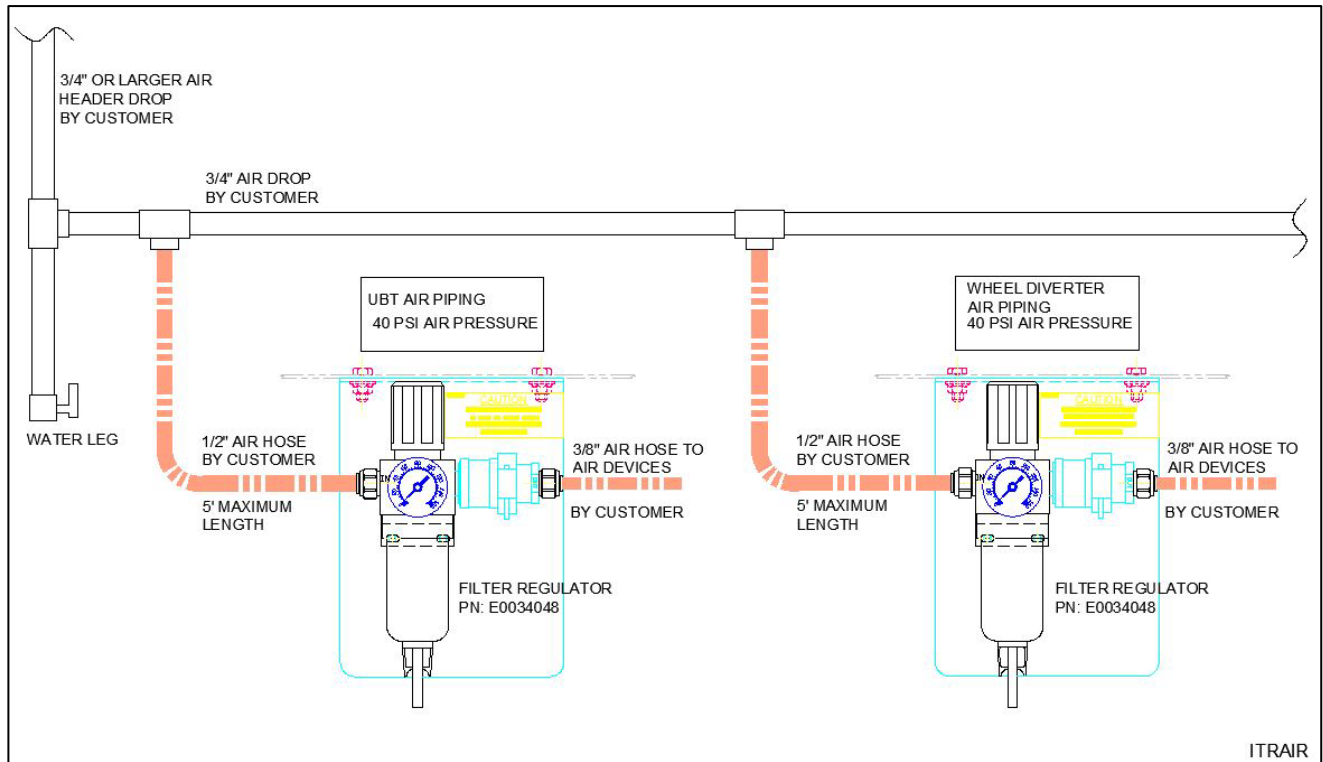

General

Every conveyor system is unique, with its own specific requirements. Therefore, the following is a general guide.

Main Feeder

Air velocity through the main feeder piping can be kept smooth with lower losses using large diameter pipe with minimum bends and restrictions. Standard weight black pipe or copper is suitable for plumbing the compressed air overhead to all points of use.

Air Drops

MHS Conveyor recommends using 3/4" pipe on air drops for low pressure loss. The drop is terminated with a drain at the bottom. A tee located prior to the drain (drop leg) branches off to the conveyor. This branch line must contain a lockout/shutoff. A shutoff must also be located in the drop before the branch tee.

OSHA Rule 29, CFR1910.147 <https://www.osha.gov/> requires energy sources (air drops) be turned off and capable of being locked or labeled with a warning tag.

IMPORTANT!



If your air compressor uses synthetic oil, a coalescing filter plus a regular filter of 5 micron is required. Synthetic oils will shrink the seals in pneumatic devices.

10.1 LOW PRESSURE SWITCH

An air pressure switch is recommended to be installed into the pneumatic circuit to detect a drop in air pressure below required levels. If pressure drops below approximately 40 PSI, the conveyor system should shut off.

10.2 PNEUMATIC REQUIREMENTS

- Maximum conveyor length each way from the regulator is 100'. Locate regulator in center of conveyor.
- **Recommended operating pressure set at: 40 - 45 PSI**
 - **Low Pressure Switch** set below operating pressure of 40 PSI (Typical range: 35-39 PSI)
 - **Pressure Relief Valve** set above 45 PSI (Typical range: 46-50 PSI).
- In high humidity or low temperature, use an air dryer.
- Use 5 micron filter.
- Lockout/shutoff valve, to be provided by the air system installer.

 WARNING	
	<ul style="list-style-type: none">• Whip restraints must be installed on flexible hosing. Cable ties removed from pneumatic hosing must be replaced

11 INTELLIROL POWER SUPPLY STANDARDS

11.1 ITR POWER SUPPLY STANDARD

The IntelliROL product line includes power supplies that convert various AC power sources to 24VDC power sources. These power supplies are used to supply power to the motorized roller components included in our IntelliROL product line. Power supplies are available for most standard input voltages. Available output currents include 10, 20, 40, and 80 amperes. IntelliROL power supplies are available with internal branch circuit protection. If branch circuit protection is already provided upstream by others, IntelliROL power supplies are available without internal branch circuit protection at a lower cost. All IntelliROL power supplies are designed and built to UL508A standards.

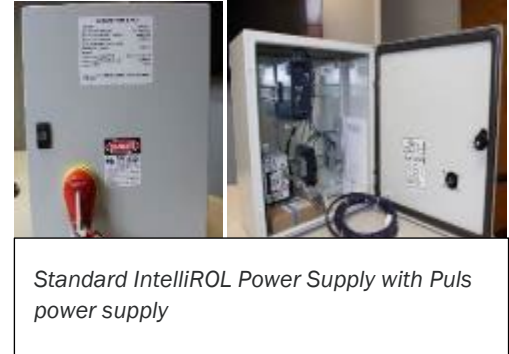

Standard IntelliROL Power Supply with Puls power supply

The 40 amp power supply has (2) 20 amp circuits and the 80 amp power supply has (4) 20 amp circuits. Each 20 amp circuit will support up to 9 motorized rollers. These supplies require either 120 or 240 VAC single-phase or 480 VAC three-phase (480 VAC 10A requires two-phase), and the DC power side is wired to the motorized rollers.

Wiring for the 24 VDC power along the length of the conveyor is provided by MHS Conveyor. See Replacement Parts in this chapter for other parts and cables for IntelliROL. All power supplies are offered with or without branch circuit protection. All power supplies except 80 amps include a 10.5' power harness (1102286) to connect to bed 24VDC power harness. All standard 80 amp power supplies include 33' power harness (1138166) to connect to bed 24VDC power harness. All power supplies also include a common ground (1161502) and splice connector kit (1207178).

For more Power Supply details, See ITR Power Supply Application Control Guidelines (IOM # 1176718):

mhs-conveyor.com

Note:

With Branch Circuit Protection on the supply side, fuses are included with power supply. Without Branch Circuit Protection, fuses are not included with power supply. Fuses on the DC output side are included.

Standard 24VDC power supplies are used for IntelliROL conveyor only. Standard power supplies can be powered from a separate power source input or tapped into a high voltage motor to a corresponding conveyor that the IntelliROL conveyor will directly interface with. Use only with motors without VFD.

24VDC STANDARD POWER SUPPLIES WITH BRANCH CURCUIT PROTECTION FOR INTELLIROL									
MHS Item Number	Drawing Number	Input Voltage	Power Supply Size	Input Current	Output Current	Number of MDR	Enclosure Type	UL Listed	Enclosure Dimensions (H x W x D)
1176603	130E233	480VAC/3PH/60HZ	80A	2.8A	80A	36	Type 12	Yes	15-3/4" X 15-3/4" X 7-7/8"
1160913	130E115	480VAC/3PH/60HZ	40A	1.4A	40A	18	Type 12	Yes	15-3/4" X 15-3/4" X 7-7/8"
1160948	130E117	240VAC/1PH/60HZ	40A	4.5A	40A	18	Type 12	Yes	15-3/4" X 15-3/4" X 7-7/8"
1160950	130E119	120VAC/1PH/60HZ	40A	8.6A	40A	18	Type 12	Yes	15-3/4" X 15-3/4" X 7-7/8"
1160915	130E116	480VAC/3PH/60HZ	20A	0.65A	20A	9	Type 12	Yes	15-3/4" X 15-3/4" X 7-7/8"
1160949	130E118	240VAC/1PH/60HZ	20A	2.23A	20A	9	Type 12	Yes	15-3/4" X 15-3/4" X 7-7/8"
1160951	130E120	120VAC/1PH/60HZ	20A	4.64A	20A	9	Type 12	Yes	15-3/4" X 15-3/4" X 7-7/8"
1166694	130E174	480VAC/3PH/60HZ	10A	0.6A	10A	3	Type 12	Yes	15-3/4" X 15-3/4" X 7-7/8"
1166695	130E175	240VAC/1PH/60HZ	10A	1.13A	10A	3	Type 12	Yes	15-3/4" X 15-3/4" X 7-7/8"
1166696	130E176	120VAC/1PH/60HZ	10A	2.15A	10A	3	Type 12	Yes	15-3/4" X 15-3/4" X 7-7/8"

24VDC STANDARD POWER SUPPLIES WITHOUT BRANCH CURCUIT PROTECTION FOR INTELLIROL									
MHS Item Number	Drawing Number	Input Voltage	Power Supply Size	Input Current	Output Current	Number of MDR	Enclosure Type	UL Listed	Enclosure Dimensions (H x W x D)
1176628	130E234	480VAC/3PH/60HZ	80A	2.8A	80A	36	Type 12	Yes	15-3/4" X 15-3/4" X 7-7/8"
1159645	130E121	480VAC/3PH/60HZ	40A	1.4A	40A	18	Type 12	Yes	15-3/4" X 15-3/4" X 7-7/8"
1160953	130E123	240VAC/1PH/60HZ	40A	4.5A	40A	18	Type 12	Yes	15-3/4" X 15-3/4" X 7-7/8"
1160955	130E125	120VAC/1PH/60HZ	40A	8.6A	40A	18	Type 12	Yes	15-3/4" X 15-3/4" X 7-7/8"
1159647	130E122	480VAC/3PH/60HZ	20A	0.65A	20A	9	Type 12	Yes	15-3/4" X 15-3/4" X 7-7/8"
1160954	130E124	240VAC/1PH/60HZ	20A	2.23A	20A	9	Type 12	Yes	15-3/4" X 15-3/4" X 7-7/8"
1160956	130E126	120VAC/1PH/60HZ	20A	4.64A	20A	9	Type 12	Yes	15-3/4" X 15-3/4" X 7-7/8"
1166697	130E177	480VAC/3PH/60HZ	10A	0.6A	10A	3	Type 12	Yes	15-3/4" X 15-3/4" X 7-7/8"
1166698	130E178	240VAC/1PH/60HZ	10A	1.13A	10A	3	Type 12	Yes	15-3/4" X 15-3/4" X 7-7/8"
1166699	130E179	120VAC/1PH/60HZ	10A	2.15A	10A	3	Type 12	Yes	15-3/4" X 15-3/4" X 7-7/8"

11.2 ITR AND CRUZCONTROL POWER SUPPLY COMBINATION

Combination 24VDC power supplies are used with IntelliROL and conveyor with CRUZcontrol. The power supplies have two 24VDC circuits, Class I for the IntelliROL and Class II for the CRUZcontrol. Combination power supplies can be powered from a separate power source input or tapped into a high voltage motor to a corresponding conveyor that the IntelliROL conveyor will directly interface with. Use only with motors without VFD.

24VDC COMBINATION POWER SUPPLIES WITH BRANCH CURCUIT PROTECTION FOR INTELLIROL AND CRUZCONTROL										
MHS Item Number	Drawing Number	Input Voltage	Power Supply Size	Input Current	Output Current		Number of MDR	Enclosure Type	UL Listed	Enclosure Dimensions (H x W x D)
					ITR	CRUZ				
1160917	130E103	480VAC/3PH/60HZ	40A	1.4A	36	4	17	Type 12	Yes	15-3/4" X 15-3/4" X 7-7/8"
1160919	130E105	240VAC/1PH/60HZ	40A	4.5A	36	4	17	Type 12	Yes	15-3/4" X 15-3/4" X 7-7/8"
1160921	130E107	120VAC/1PH/60HZ	40A	8.6A	36	4	17	Type 12	Yes	15-3/4" X 15-3/4" X 7-7/8"
1160918	130E104	480VAC/3PH/60HZ	20A	0.65A	16	4	8	Type 12	Yes	15-3/4" X 15-3/4" X 7-7/8"
1160920	130E106	240VAC/1PH/60HZ	20A	2.23A	16	4	8	Type 12	Yes	15-3/4" X 15-3/4" X 7-7/8"
1160922	130E108	120VAC/1PH/60HZ	20A	4.64A	16	4	8	Type 12	Yes	15-3/4" X 15-3/4" X 7-7/8"
1166700	130E180	480VAC/3PH/60HZ	10A	0.6A	6	4	2	Type 12	Yes	15-3/4" X 15-3/4" X 7-7/8"
1166701	130E181	240VAC/1PH/60HZ	10A	1.13A	6	4	2	Type 12	Yes	15-3/4" X 15-3/4" X 7-7/8"
1166702	130E182	120VAC/1PH/60HZ	10A	2.15A	6	4	2	Type 12	Yes	15-3/4" X 15-3/4" X 7-7/8"

24VDC COMBINATION POWER SUPPLIES WITHOUT BRANCH CURCUIT PROTECTION FOR INTELLIROL AND CRUZCONTROL										
MHS Item Number	Drawing Number	Input Voltage	Power Supply Size	Input Current	Output Current		Number of MDR	Enclosure Type	UL Listed	Enclosure Dimensions (H x W x D)
					ITR	CRUZ				
1160923	130E109	480VAC/3PH/60HZ	40A	1.4A	36	4	17	Type 12	Yes	15-3/4" X 15-3/4" X 7-7/8"
1160925	130E111	240VAC/1PH/60HZ	40A	4.5A	36	4	17	Type 12	Yes	15-3/4" X 15-3/4" X 7-7/8"
1160927	130E113	120VAC/1PH/60HZ	40A	8.6A	36	4	17	Type 12	Yes	15-3/4" X 15-3/4" X 7-7/8"
1160924	130E110	480VAC/3PH/60HZ	20A	0.65A	16	4	8	Type 12	Yes	15-3/4" X 15-3/4" X 7-7/8"
1160926	130E112	240VAC/1PH/60HZ	20A	2.23A	16	4	8	Type 12	Yes	15-3/4" X 15-3/4" X 7-7/8"
1160928	130E114	120VAC/1PH/60HZ	20A	4.64A	16	4	8	Type 12	Yes	15-3/4" X 15-3/4" X 7-7/8"
1166703	130E183	480VAC/3PH/60HZ	10A	0.6A	6	4	2	Type 12	Yes	15-3/4" X 15-3/4" X 7-7/8"
1166704	130E184	240VAC/1PH/60HZ	10A	1.13A	6	4	2	Type 12	Yes	15-3/4" X 15-3/4" X 7-7/8"
1166705	130E185	120VAC/1PH/60HZ	10A	2.15A	6	4	2	Type 12	Yes	15-3/4" X 15-3/4" X 7-7/8"

11.3 ITR POWER SUPPLY MOTOR CONTROL

The Motor Control 24VDC power supply is used with a 480 VAC motor. The Motor Control power supply is powered from the same power source as the high voltage motor that IntelliROL will directly interface with. Use only with motors without VFD.

MOTOR CONTROL 24VDC POWER SUPPLIES FOR INTELLIROL (USED ONLY WITH MOTORS W/O VFD)										
MHS Item Number	Drawing Number	Input Voltage	Power Supply Size	Input Current	Output Current	Number of MDR	Enclosure Type	UL Listed	Enclosure Dimensions (H x W x D)	
1145930	130E042	480VAC/3PH/60HZ	10A	0.6A	10A	3	Type 12	Yes	12"X 12" X 8"	
1145931	130E043	480VAC/3PH/60HZ	20A	0.65A	20A	9	Type 12	Yes	12"X 12" X 8"	

11.4 ITR POWER SUPPLY MOUNTING BRACKET KITS

Mounting Brkt for ITR STD & CMB, Under Mount 15-3/4"x15-3/4" & 12"x12"

NOTE:
THE FLANGES OF THE BRACKETS FACE THE SAME DIRECTION
THERE ARE NO RH AND LH MOUNTING BRACKETS

	(A)	ITEM 01
KIT FOR POWER SUPPLY		
16BF	1216387	1216190
22BF	1216388	1216191
28BF	1216389	1216192
34BF	1216390	1216193

12 X 12 ENCLOSURE SPACING 15-3/4 X 15-3/4 ENCLOSURE SPACING ASSEMBLY (A) 15-3/4" X 15-3/4" ASSEMBLY (A) 12" X 12"

ITR POWER SUPPLY MOUNTING BRACKET
SIDE/UNDER MOUNT 16S121

Mounting Brkt for ITR STD & CMB, Low Profile Side Mount 15-3/4"x15-3/4" & 12"x12"



NOTE:
THE FLANGES OF THE BRACKETS FACE THE SAME DIRECTION
THERE ARE NO RH AND LH MOUNTING BRACKETS

	(A)	ITEM 01
KIT FOR POWER SUPPLY		
16BF	1216387	1216190
22BF	1216388	1216191
28BF	1216389	1216192
34BF	1216390	1216193



12 X 12 ENCLOSURE SPACING 15-3/4 X 15-3/4 ENCLOSURE SPACING ASSEMBLY (A) 15-3/4" X 15-3/4" ASSEMBLY (A) 12" X 12"

ITR POWER SUPPLY MOUNTING BRACKET
SIDE/UNDER MOUNT 16S121

12 GENERAL ELECTRICAL REQUIREMENTS



 WARNING	
	<ul style="list-style-type: none">• All electrical controls must be installed, wired, and connected by a licensed electrician only.• All motor controls and wiring must conform to the National Electrical Code as published by the National Fire Protection Association and approved by the American National Standards Institute, Inc. Since specific electrical codes vary from one area to another, be sure to check with proper authorities before starting.



The electrical voltage of motorized rollers will be stamped on a metal name plate affixed to one end of the roller. This voltage should be checked to see that it matches the output voltage of your power supply. Consult the appropriate MHS Conveyor wiring diagram for the proper connections. If a single speed three phase motorized roller runs the wrong direction, two leads must be switched to reverse rotation.

 WARNING	
	<ul style="list-style-type: none">• Do not connect the driver card to any other voltage than the one listed on its name plate.

NOTE:

All controls equipment is covered by the original manufacturer's equipment warranty.

 WARNING	
	<ul style="list-style-type: none">• All safety devices, including wiring of electrical safety devices, shall be arranged to operate in a “fail safe” manner. That is, if power failure or failure of the device itself would occur, a hazardous condition must not result.

 WARNING	
	<ul style="list-style-type: none">• Before restarting a conveyor, which has been stopped because of an emergency, an inspection of the conveyor must be made and the cause of the stoppage determined. The starting device must be locked out before any attempt is made to correct the cause of stoppage.

12.1 CRUZCONTROL TECHNICAL DATA

CRUZcontrol Power Supply Specification

Technical Data	PN 1117431	PN 1117432
Input Parameters		
Input Voltage Range V AC (nominal)	100...120/220...240 V	380...480 V (2 phase)
Input Voltage Range V AC (continuous)	85...132/1184...264 V	323...552 V (2 phase)
Input Frequency	47...63 Hz	47...63 Hz
Phase	1	2
Input Voltage Range V DC (see derating requirements)	220...375 V	consult factory
Input Rated Current	< 2.0 A (100 V AC)	< 0.42 A (400 V AC)
	< 0.95 A (196 V AC)	< 0.36 A (480 V AC)
Transient Immunity Over Entire Load Range		Consult factory
Output Parameters		
Output Voltage	24...28 V DC	24...28 V DC
Output Voltage Preset	24.5 V DC ±0.5%	24.5 V DC ± 0.5%
Ripple/Noise @ 20 MHz, 50 Ohm	< 50 m Vpp	< 50 m Vpp
Output Voltage Regulation Accuracy	0.5% Vout static ±1.5% Vout dynamic	± 200 mV static Dynamic not available
Output Rated Current	3.9 A (at 24 V) 3.2 A (at 28 V)	3.75 A (at 24 V) 3.2 A (at 28 V)
Hold Up Time	> 20 ms (196 V AC, 24.5V/3.9 A) > 20 ms (100 V AC, 24.5 V/3.9A)	Typ. 52 ms (at 400 V) Typ. 93 ms (at 480 V)
General Device Parameters		
Operating Temperature Range (Tamb) - Full Load	14...140°F (-10...60 C)	14...140°F (-10...60 C)
Operating Temperature Range (Tamb) - Derated	122...140°F (50...60 C)	122...140°F (50...60 C)
Storage Temperature	-13...185°F (-25...85 C)	-13...185°F (-25...85 C)
Humidity (Do not energize when condensation is present)	< 93%	< 95%
Input Cable Access	3/4 or 1/2 in. hole for conduit	
AC Connection Wires		
Stranded cable	0.3...2.5 mm ² / AWG 28-12	≥ 2,5 mm ² , AWG 26-12
Solid cable	0.3...4 mm ² / AWG 28-12	≥ 2,5 mm ² , AWG 26-12
Stripping at wire end	6 mm	6 mm
<i>Note: secure wires from strain</i>		
AC External Protection/Fusing	20A Max	30A Max
Output Connector Cables	M12 4-pin "T" cable	M12 4-pin "T" cable
Efficiency	90% (typical at 230 V AC, 3.9A)	89.5% (at 400 V) 89.0% (at 480 V)
Protection Class - Type 1 Enclosure	IP 20 (DIN/IEC 60 529)	IP 20 (DIN/IEC 60 529)
MTBF	500,000 h @ 40C SN 29500	1.5 Mio h @ 40C SN 29500
	Not tested at MIL 217 GP40	482,000 h @ MIL 217 GP40
Dimensions	9.25 x 5.67 x 5.13 (235 x 144 x 130.4 mm)	9.25 x 5.67 x 5.13 (235 x 144 x 130.4 mm)
Weight	3.9 lbs (1.8 kg)	4.4 lbs (2.0 kg)
Cover Screw Torque Rating (in-lb)	4±1	4±1
Mounting	Vertical mounting only. AC input enters from the bottom	
Clearance	Keep 4 in. clearance from ventilating slots in cover	
Applicable Standards		
EN 60 950-1, IEC 60 950	Yes	Yes
EN 60 204-1, EN 50 178	Yes	Yes
Third Party Approvals		
UL 508 Listing (US and Canada)	Multiple Listing	Multiple Listing
UL 60 950-1 Recognition (US and Canada)	Multiple Listing	Multiple Listing
NEC Class 2 According to UL 1310	Multiple Listing	Multiple Listing

For more CRUZcontrol (IOM# 1118211) details visit mhs-conveyor.com

13 ITOH DENKI CBM-105 & CB-016 DRIVERCARD

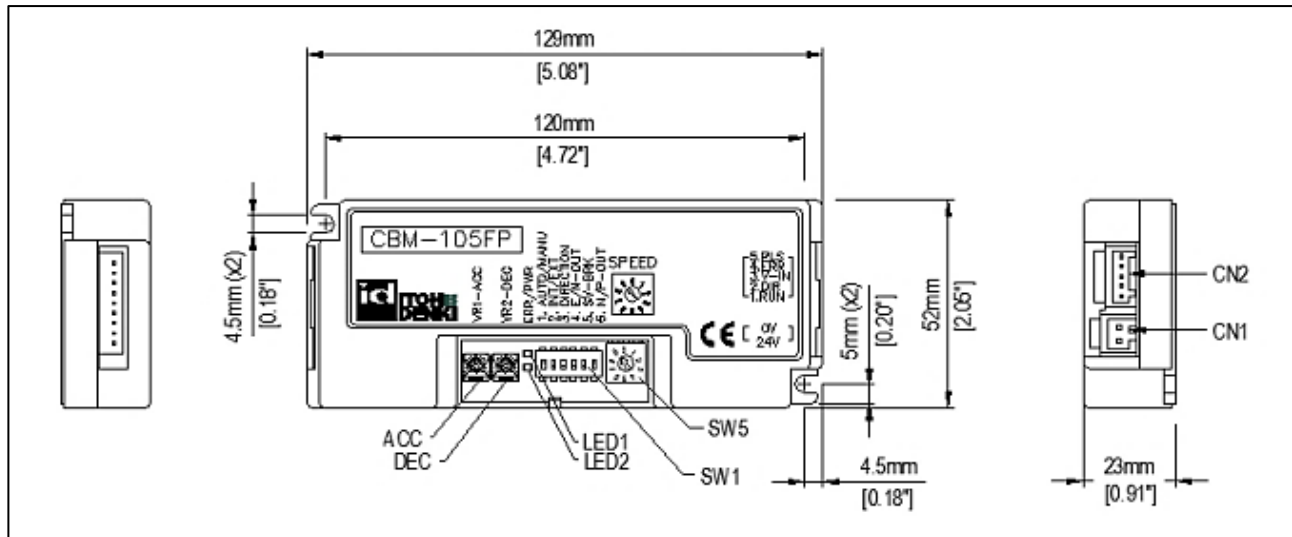

13.1 CBM-105 & CB-016 DRIVERCARD GENERAL NOTES:

- For “transportation” conveyor segments, and devices not requiring zoned accumulation (transfers, merges, wheel diverts). Requires PLC or other external control for basic run and reverse functions.
- MHS Conveyor CBM-105 (ITR^{CB}) conveyor includes:
 - Power harness – installed with taps to individual drivercards and bed-to-bed plug-in connections.
 - Drivercard – installed, connected to power harness, and speed pre-set.
 - CN2 – 5-PIN connector installed in card with “run harness” pre-wired to all cards.
 - Motorized rollers – installed in bed, motor cable connected.

All beds factory tested for flow direction, speed, and proper plug-in connections.

13.2 CBM-105 & CB-016 FEATURES:

- Adjustable acceleration and deceleration time (0 to 2.5 seconds)
- Stable speed operation
- Manual or automatic recover of the thermal overload device
- One (1) rotary switch to select up to 10 different fixed speeds or external voltage input for up to 20 fixed speeds
- Forcibly stops motor if motor is locked for more than 4 seconds or thermal overload error lasts for 1 second or more
- Two (2) LEDs (red & green) to identify the type of error and power
- Back EMF error for over speeding protection
- Pulse signal output to indicate motor revolution
- Servo brake control allows product to maintain its position after run signal is removed
- Error output selection for output in normal or abnormal status

- Low Voltage Protection – See “LED’s and Error Indications” section
- External Direction control – See “User Interface Switch Settings” section

13.3 CBM-105 & CB-016 SPECIFICATIONS:

Operation:

- Cycle: 1 second ON; 1 second OFF (max on-off cycles 30/minute)
- Continuous duty permissible
- Do not overfeed by 150% of no-load operating speed (back EMF will be generated)
- Power: +24V DC +/-10% (full-wave rectified, smoothed current <10% ripple)
- Power ON delay <1 second
- 4 Amp locking current
- Input signal level for activation minimum 18V for PNP
- See “Connections” section for I/O circuit current limitations/requirements
- PNP circuitry for all I/O, except for CN2 output 2-4, which is configurable as PNP or NPN.
- Servo brake mode – See “User Interface Switch Settings” section

Protection:

- Thermal Overload 185 °F (85 °C) on PCB
- Thermal Overload 221 °F (105 °C) in motor
- 5 Amp Internal fuse (non-replaceable) to power supply
- Internal diode circuit protection (Voltage Polarity)

Environment:

- Ambient Temperature 32-104 °F (0-40 °C)
- <90% Relative Humidity (No condensation)
- No Corrosive Gases
- Vibration <0.5G

See Itoh-Denki technical document for additional information: itohdenki.com

13.3.1 CBM-105 & CB-016 Connections

CN1 – 2 PIN connector for Power		Male Connector on Card WAGO #734-162	Female Connector for Wiring WAGO #734-102 TGW PN:1104417 & 18
PIN	Description		
1	+24VDC +/-10% (full-wave rectified, smoothed current <10% ripple)		Wire Size: 28-14AWG
2	0V		

CN2 5 PIN connector for external control		Male Connector on Card WAGO #733-335	Female Connector for Wiring WAGO #733-105 TGW PN:733105 & 1104417
PIN	Description		
1	+24V DC (Input) – RUN		Wire Size: 28-20AWG
2	+24V DC (Input) – DIR		
3	0-+10V DC (Input) – V-IN (Allows analog speed control, 1.6mA/card)		
4	+24V DC (Output) – ERR (Open collector: 25mA max)		
5	+24V DC (Output) – PLS (Open collector: 25mA max)		

CN3 – 9 PIN connector for Motor	Male Connector on Card JST #S9B-XH-A	Female Connector for Wiring JST #XHP-9
PIN	Description	
1	GND - Grey	<p>Wire Size: 28-22AWG & 24-22AWG motor phases</p> <p>Terminal pins: JST #SXH-001T-P0.6</p>
2	+12V DC – Blue	
3	Motor Phase U – Red	
4	Motor Phase V – White	
5	Motor Phase W – Black	
6	Hall Sensor U – Violet	
7	Hall Sensor V – Orange	
8	Hall Sensor W – Green	
9	Thermistor – Light Blue	

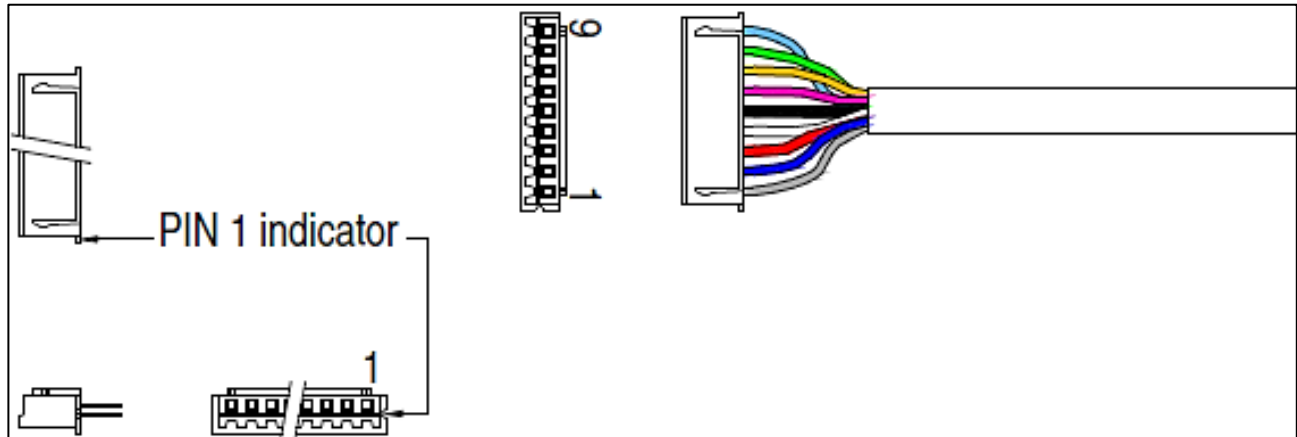

13.3.2 CBM-105& CB-016 Installation Precautions

Precaution	Action	Reason
Power Supply	Power supply must be sized appropriately for the number of cards/rollers it provides power to. See "Power Supply Application Information" section.	Exceeding the power supply capacity can cause low voltage issues.
Multiple power supplies	0V line of all power supplies associated with a conveyor "unit" (cards, rollers, and external controls) need to be connected.	This completes the signal path between conveyor sections and system controls.
Voltage drop across power bus	Use suitable gauge wire in relation to distance and current draw.	Voltage must not drop below 21.6V DC or voltage faults will occur

13.3.3 CBM-105 & CB-016 User Interface Switch Settings

DIP Switches (SW1) – User Settings				
DIP Switch	Function	ON	OFF	Default Setting
1	Thermal device/low voltage/back EMF recover	Manual	Automatic (Thermal restarts 1min after cool down)	ON
2	Speed change selection	External (0~10V DC applied)	Internal (Rotary switch)	OFF
3	DIR* (No external DIR signal; viewed from cable side)	FS/FP – CCW FE – CW	FS/FP – CW FE – CCW	OFF
4	Error signal activity	Active during normal status	Active during abnormal status	ON
5	Brake mode	Servo	Dynamic	OFF
6	Error output (FN type)	PNP	NPN	OFF
	Error output (FP type)	PNP	NPN	ON

*External direction signal only. If a direction change signal should occur while the motor is running, the motor will first stop for 0.5s. The motor will then start in the new direction.

Rotary switch (SW2)

Applicable when using internal speed control (DIP-SW2 OFF)

Factory default position 9 (highest speed), MHS Conveyor presets speeds on production beds

Potentiometers*

VR1 – Acceleration

Adjust acceleration time from 0~2.5 seconds after the RUN signal is applied

VR2 – Deceleration

Adjust deceleration time from 0~2.5 seconds after the RUN signal is removed

*VR's turn 270°

Brake

Servo Brake mode with DIP-SW 1-5 ON

- Holds Power Roller in position 0.2 seconds after the RUN signal is removed
- If external force moves the Power Roller it will return back to its initial stopped position
- Maximum holding force is 17.7 lb.-in at 1.0 Amp (Based on a PM486FE-60)
- Servo brake does not function during an error condition

Motor pulse output signal

- NPN (0V) output from CN2-5
- Two (2) pulses per motor revolution

13.3.4 CBM-105& CB-016 LED's and Error Indications

Status	LED1 (green)	LED2 (red)	ERR Output (DIP-SW4 setting)		Error Condition*	Result	Solution
			OFF	ON			
Normal	● (ON)	○ (OFF)	○	●	n/a	n/a	n/a
No power	○ (OFF)	○ (OFF)	○	○	n/a	No operation	
Thermal overload	● (ON)	● (ON)	●	○	Motor or PCB above operating temperature		1
Motor lock	● (ON)	Blinks (1Hz) ● ○	●	○	Motor locked (>4s)		2
Motor unplugged	● (ON)	● (ON)	●	○	Motor not connected to card		3
Open Fuse	○ (OFF)	Blinks (6Hz) ●●●●●○ ●●●●●○	●	○	Current exceeded 5A		4
Back EMF	● (ON)	Blinks/off (6Hz) ●●●●●○ ○○○○○○	●	○	Supply voltage >40V DC for 2s, or 60V DC for 0.1s		5
Low voltage (<15V)	● (ON)	Blinks (6Hz) ●●●●●○ ●●●●●○	●	○	<15V DC (>1s or 5x in 0.5s)		6

13.3.5 CBM-105 & CB-016 Solution

1. See more information under Input / Output Settings, DIP switch 1-8
 - A signal applied to CN2-1 (RUN), or CN2-2 (DIR) will reset this error status
 - Thermal overload can only be reset if the temperature has fallen back into the operating range
2. Remove the cause of the motor lock and clear the zone
3. Remove power from the card, plug in the motor connector, and then reapply power
4. Replace the card
5. If card detects back EMF over 40V DC for 2sec or 60V DC for 0.1sec, the motor will stop running and go into dynamic brake condition to slow the product down
 - Back EMF results from forcing a roller to run at >150% of its set operating speed
 - If DIP-SW1 is ON (Manual recovery), card must be reset 1sec after voltage drops under 30V DC. Applying a signal to CN2-1 or CN2-1 will reset error.
 - If DIP-SW1 is OFF (Automatic recover), card will restart roller 1sec after the voltage drops below 30V DC (if run signal is active)
6. Check power supply output, voltage drop along power bus, and roller count per power supply.

13.3.6 ITR CBM-105 & CB-016 Electrical Components

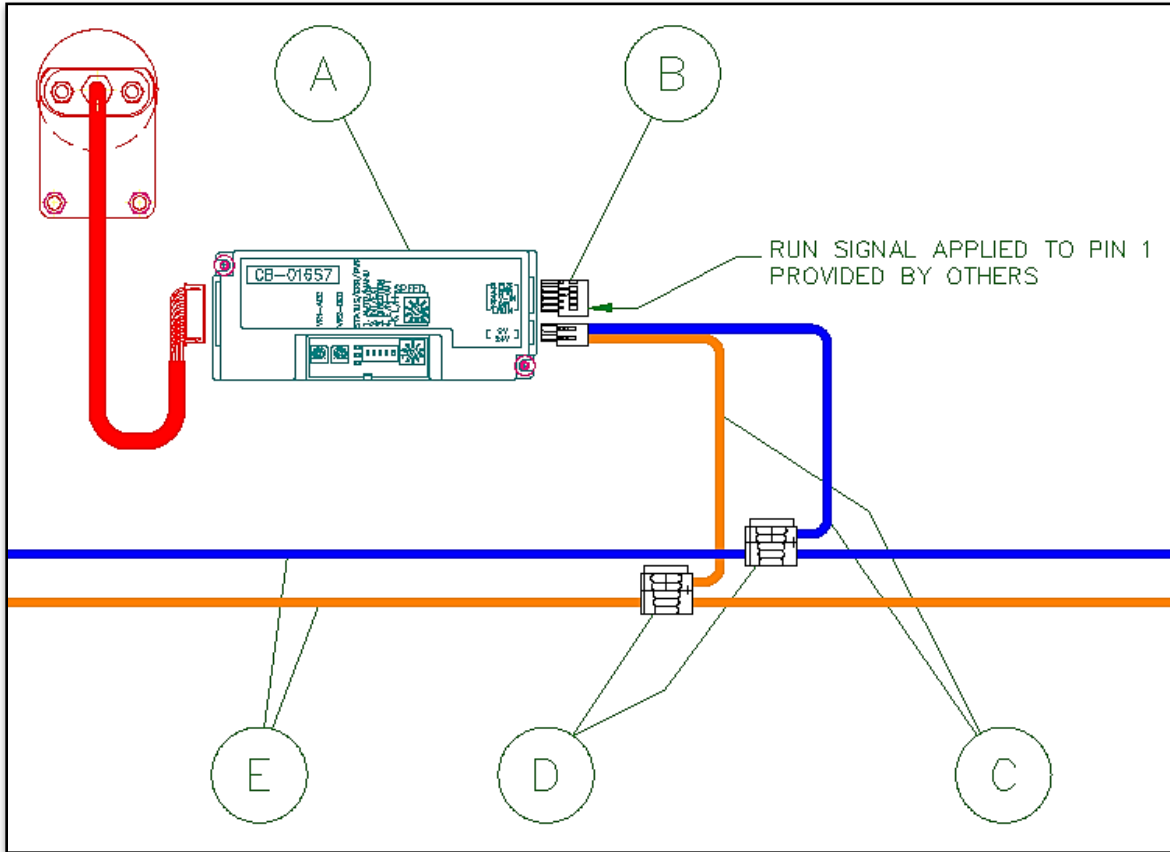

Figure 1 –CBM-105 Drivercard and CB-016

- A. CB-016P7 (P/N 1139716 with hardware) or CB-105FP (P/N 1153931 with hardware)
- B. 5-Pin connector (for run signal connection): 733105
- C. Power tap cable (for short distances < 6”): 1139543
- D. Scotchlok connectors (connect power tap to power harness): 3M567 (Brown)
- E. Power harness – see power harness table

Table1: Power Harness

Item No.	Description
1129502	HARNESS,ITR-POWER-10AWG-12.5'
1102286	HARNESS,ITR-POWER-10AWG-10.5'
1102287	HARNESS,ITR-POWER-10AWG-8'
1102288	HARNESS,ITR-POWER-10AWG-5.5'
1102289	HARNESS,ITR-POWER-10AWG-3'

13.3.7 CBM-105 Drivercard Speed Chart

CBM-105 DRIVERCARD / FE-___ ROLLER											
ROLLER: FE-17			ROLLER: FE-60			ROLLER: FE-100			ROLLER: FE-140		
MHS NOMINAL SPEED	ROTARY SWITCH	ACTUAL SPEED ± 5% (fpm)	MHS NOMINAL SPEED	ROTARY SWITCH	ACTUAL SPEED ± 5% (fpm)	MHS NOMINAL SPEED	ROTARY SWITCH	ACTUAL SPEED ± 5% (fpm)	MHS NOMINAL SPEED	ROTARY SWITCH	ACTUAL SPEED ± 5% (fpm)
6	0	6.9	25	0	24.6	85	0	87.5	85	0	87.5
9	1	9.2	30	1	32.8	115	1	116.6	115	1	116.6
13	2	13.8	45	2	49.2	170	2	174.9	170	2	174.9
18	3	18.4	65	3	65.6	230	3	233.2	230	3	233.2
25	4	27.7	95	4	98.4		4	349.7/(285.7)	345	4	349.7
35	5	36.9	130	5	131.2		5			5	466.3/(408.2)
40	6	41.5	145	6	147.6		6			6	524.7/(408.2)
45	7	46.1	160	7	164	285	7	433.1/(285.7)	405	7	
	8	50.7/(48.0)		8	180.4/(170.6)		8			8	566.2/(408.2)
50	9	55.3/(48.0)	180	9	196.8/(170.6)		9			9	

Note: Speed with two numbers are " NO-LOAD / RATED". Rated numbers are what the roller is capable of doing under a continuous duty full load condition.

CBM-105 DRIVERCARD / FP-___ ROLLER								
ROLLER: FP-55			ROLLER: FP-100			ROLLER: FP-140		
MHS NOMINAL SPEED	ROTARY SWITCH	ACTUAL SPEED ± 5% (fpm)	MHS NOMINAL SPEED	ROTARY SWITCH	ACTUAL SPEED ± 5% (fpm)	MHS NOMINAL SPEED	ROTARY SWITCH	ACTUAL SPEED ± 5% (fpm)
25	0	26.7	120	0	121.7	120	0	121.7
35	1	35.6	160	1	162.3	160	1	162.3
50	2	53.4	240	2	243.4	240	2	243.4
70	3	71.2		3	324.5/(306.3)	320	3	324.5
105	4	106.8		4			4	486.6/(470.7)
140	5	142.4		5			5	
160	6	160.2	305	6			6	
175	7	178.0/(175.5)		7	446.0/(306.3)	470	7	627.1/(470.7)
	8	195.8/(175.5)		8			8	
180	9	213.7/(175.5)		9			9	

Note: Speed with two numbers are " NO-LOAD / RATED". Rated numbers are what the roller is capable of doing under a continuous duty full load condition.

13.3.8 CB-016 Drivercard Speed Chart

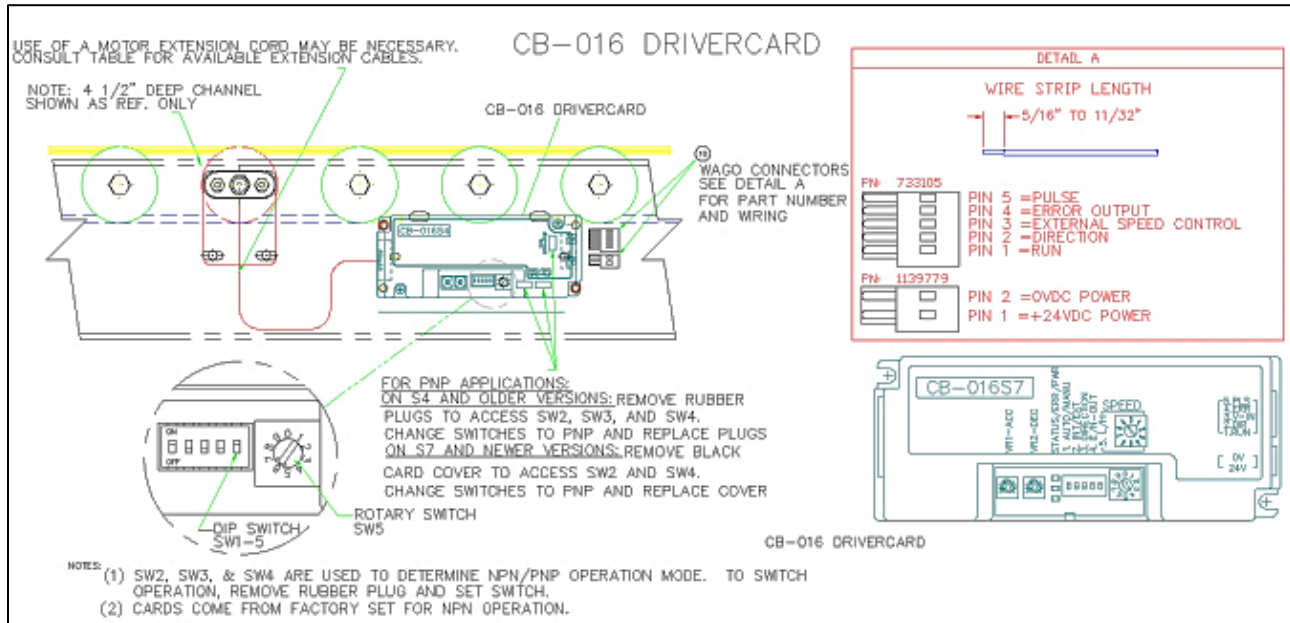

SPEED CHANGE TABLE										CB-016 DRIVERCARD	
20 DISCREET SPEED CHANGE STEPS FOR INTERNAL CONTROL VIA DIP SWITCH AND ROTARY SWITCH		FP ROLLERS (FPM)			FE ROLLERS (FPM)			FS ROLLERS (FPM)			
DIP SW1-5	ROTARY SW5	100,140, 190,255	20,30, 45,55	5,8, 10,15	70,100,14 0180,210	20,30,45 55,60	5,8,10, 15,17	20,30, 45,55	5,8, 10,15		
ON	9	971.9	214.1	56.8	698.9	197.5	55.4	214.1	56.8		
ON	8	890.9	196.3	52.1	640.6	181.0	50.8	196.3	52.1		
ON	7	850.4	187.3	49.7	611.5	172.8	48.5	187.3	49.7		
ON	6	809.9	178.4	47.3	582.4	164.5	46.2	178.4	47.3		
ON	5	769.4	169.5	45.0	553.3	156.3	43.9	169.5	45.0		
ON	4	728.9	160.6	42.6	524.1	148.1	41.6	160.6	42.6		
ON	3	647.9	142.7	37.9	465.9	131.6	36.9	142.7	37.9		
ON	2	607.4	133.8	35.5	436.8	123.4	34.6	133.8	35.5		
ON	1	566.9	124.9	33.1	407.6	115.2	32.3	124.9	33.1		
ON	0	526.4	116.0	30.8	378.5	106.9	30.0	116.0	30.8		
OFF	9	485.9	107.0	28.4	349.4	98.7	27.7	107.0	28.4		
OFF	8	445.4	98.1	26.0	320.3	90.5	25.4	98.1	26.0		
OFF	7	404.8	89.2	23.7	291.1	82.3	23.1	89.2	23.7		
OFF	6	364.3	80.3	21.3	262.0	74.0	20.8	80.3	21.3		
OFF	5	324.0	71.4	18.9	233.0	65.8	18.5	71.4	18.9		
OFF	4	283.5	62.5	16.6	203.9	57.6	16.2	62.5	16.6		
OFF	3	243.0	53.5	14.2	174.8	49.4	13.9	53.5	14.2		
OFF	2	202.5	44.6	11.8	145.6	41.1	11.5	44.6	11.8		
OFF	1	162.0	35.7	9.5	116.5	32.9	9.2	35.7	9.5		
OFF	0	121.5	26.8	7.1	87.4	24.7	6.9	26.8	7.1		

14 ITOH DENKI HB-510 DRIVERCARD

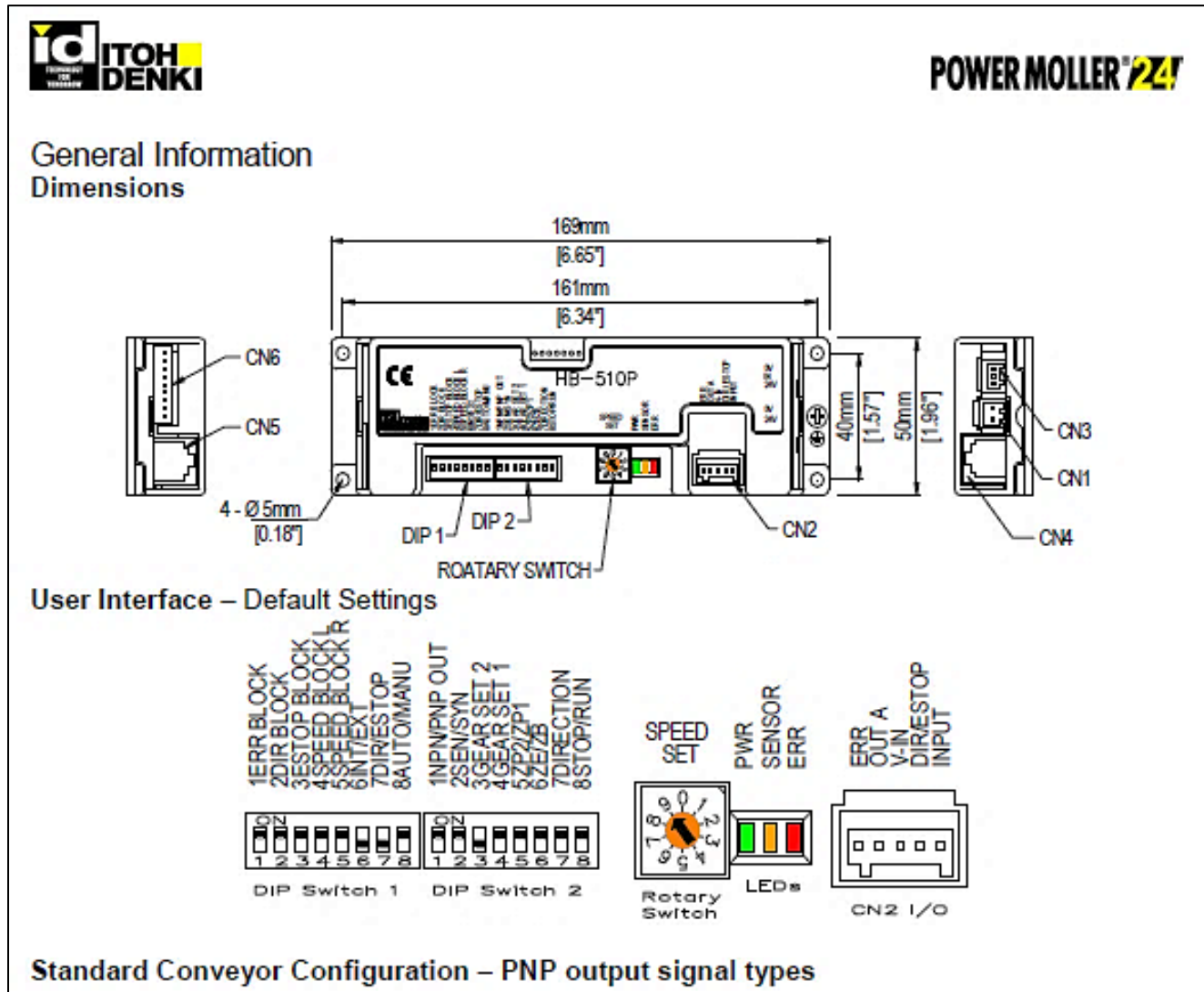

14.1 HB-510 GENERAL NOTES

- Local accumulation control with minimal higher level control system interface requirement (infeed zone, line full status, discharge zone). See Application Guideline section for details.
- MHS Conveyor HB-510 conveyor (ITRHB) includes:
 - Zone sensor – installed, connected, and pre-aligned to reflector.
 - Power harness – installed with taps to individual drivercards and bed-to-bed plug-in connections.
 - Drivercard – installed, connected to power harness and sensor, and speed pre-set.
 - Card-to-card communication cables (CAT5E) factory installed.
 - CN2 – 5-PIN connector installed in card.
 - Motorized rollers – installed in bed, motor cable connected.

- All beds factory tested for PE alignment, flow direction, speed, and proper plug-in connections.

See Itoh-Denki technical document for additional information: itohdenki.com/

14.2 HB-510 FEATURES

- A. Built in thermal protection for both driver card and power roller
- B. Three LED's to identify type of error and number of occurrences
- C. Dynamic brake control
- D. Stable speed function to ensure articles of different weights travel at the same rate
- E. Variable speed control by rotary switch or by external voltage input for up to 10 speeds
- F. Direction control by onboard DIP switch or external signal input
- G. Logic for general zero pressure accumulation (ZPA) control is built in
- H. Direct connection for photo eye to both power it and receive its output signal
- I. Easy connection between adjacent HB-510's with Cat5E communication cable to simplify wiring
- J. Flexible Zone Recognition (patented) to handle long articles which simultaneously block multiple sensors
- K. Also available for rollers with built-in brakes, HB-510B
- L. Compatible with Motorized Rollers PM486FS, PM486FE, PM486FP, PM570FE, PM605FE, PM635FS

Table 1: Replacement Parts –Power Harness

Item No.	Description
1129502	HARNESS, ITR-POWER-10AWG-12.5'
1102286	HARNESS, ITR-POWER-10AWG-10.5'
1102287	HARNESS, ITR-POWER-10AWG-8'
1102288	HARNESS, ITR-POWER-10AWG-5.5'
1102289	HARNESS, ITR-POWER-10AWG-3'

Table 2: Communication Cables

Item No.	Description
E0034025	CABLE, CTRLS-CAT5E-3'-GRAY
E0034026	CABLE, CTRLS-CAT5E-5'-GRAY
E0034027	CABLE, CTRLS-CAT5E-7'-GRAY
E0030796	CABLE, CTRLS-CAT5E-10'-GRAY
E0009905	CABLE, CTRLS-CAT5E-14'-GRAY
E0009904	CABLE, CTRLS-CAT5E-25'-GRAY

Cat5E cable (Upstream cable goes in right side of card, and downstream cable comes out the left side of the card, RH generally requires a longer cable). See diagrams below:

Figure 3 – HB 510 Communication Cable LH Flow

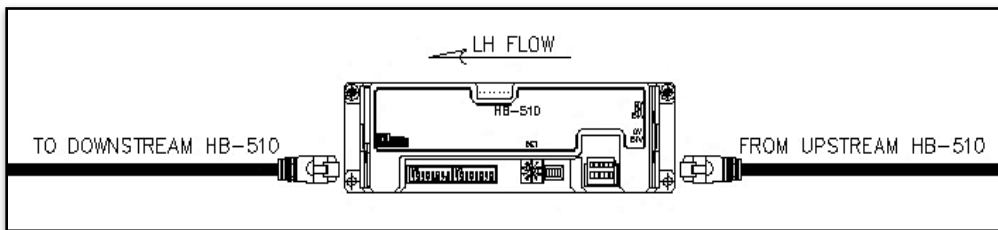
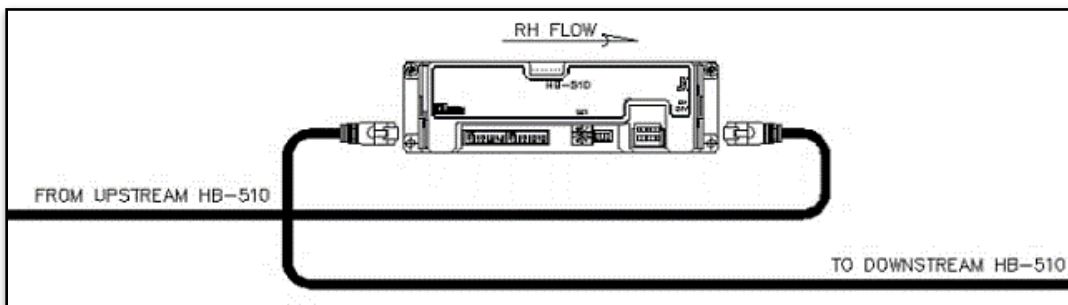

Figure 4 – HB-510 Communication Cable RH Flow



14.3.1 HB-510 Specifications

Operation:

- Cycle: 1 second ON; 1 second OFF (max on-off cycles 30/minute)
- Continuous duty permissible
- If being fed by faster upstream equipment, do not exceed 150% of no-load operating speed (back EMF will be generated)
- Power: +24V DC +/-10% (full-wave rectified, smoothed current <10% ripple)
- See “Connections” section for I/O circuit current limitations/requirements
- PNP circuitry for all I/O, except for CN2 outputs 2-4 & 2-5, which are configurable as PNP or NPN

Protection:

- Thermal Overload 185 °F (85 °C) on PCB (Printed Circuit Board)
- Thermal Overload 221 °F (105 °C) in motor
- 5A Internal fuse (non-replaceable) to power supply
- Internal diode circuit protection (Voltage Polarity)

Environment:

- Ambient Temperature 32-104 °F (0-40 °C)
- <90% Relative Humidity (No condensation)
- No Corrosive Gases
- Vibration <0.5G

14.3.2 HB-510 Connections

CN1 – 2 PIN connector for Power		Male Connector on Card WAGO #734-162	Female Connector for Wiring WAGO #734-102
PIN	Description		
1	+24VDC +/-10% (full-wave rectified, smoothed current <10% ripple)		Wire Size: 28-14AWG
2	0V		

CN2 – (Included with Card) 5 PIN connector for external control		Male Connector on Card WAGO #733-335	Female Connector for Wiring WAGO #733-105
PIN	Description		
1	+24V DC (Input) – Release, Force Run, or Force Zone Stop		Wire Size: 28-20AWG
2	+24V DC (Input) – DIR/E-stop		
3	0-+10V DC (Input) – V-IN (Allows analog speed control, 1.6mA/card)		
4	+24V DC (Output) – OUT-A (Open collector: 25mA max)		
5	+24V DC (Output) – ERR (Open collector: 25mA max)		

CN2 – (Included with Card)		Male Connector on Card	Female Connector for Wiring
5 PIN connector for external control		WAGO #733-335	WAGO #733-105
PIN	Description		
1	+24V DC (Input) – Release, Force Run, or Force Zone Stop		Wire Size: 28-20AWG
2	+24V DC (Input) – DIR/E-stop		
3	0-+10V DC (Input) – V-IN (Allows analog speed control, 1.6mA/card)		
4	+24V DC (Output) – OUT-A (Open collector: 25mA max)		
5	+24V DC (Output) – ERR (Open collector: 25mA max)		

CN3 – 3 PIN connector		Male Connector on Card	Female Connector for Wiring
for Sensor		WAGO #733-363	WAGO #733-103
PIN	Description		
1	+24V DC (Power supply to Sensor)		Wire Size: 28-20AWG
2	+24V DC (sensor signal input) – Dark Operate PNP sensor		
3	0V		

CN4 & CN5 – Control Interconnect

- CAT5E cable connection is for card to card signaling only, is not a network, and does not follow Ethernet PIN order.
- See Itoh Denki for additional information on CN 4 & 5 pin outs, as well as information for interfacing HB-510 drivercards with previous generation cards (HB-508).

CN6 – 9 or 10 PIN connector for Motor (10 PIN for brake roller)		Male Connector on Card JST #S9B-XH-A (S10B if brake)	Female Connector for Wiring JST #XHP-9 (-10 if brake)
PIN	Description		
1	GND - Grey		Wire Size: 28-22AWG & 24-22AWG motor phases Terminal pins: JST #SXH-001T-P0.6
2	+12V DC – Blue		
3	Motor Phase U – Red		
4	Motor Phase V – White		
5	Motor Phase W – Black		
6	Hall Sensor U – Violet		
7	Hall Sensor V – Orange		
8	Hall Sensor W – Green		
9	Thermistor – Light Blue		
10	Brake - Yellow		

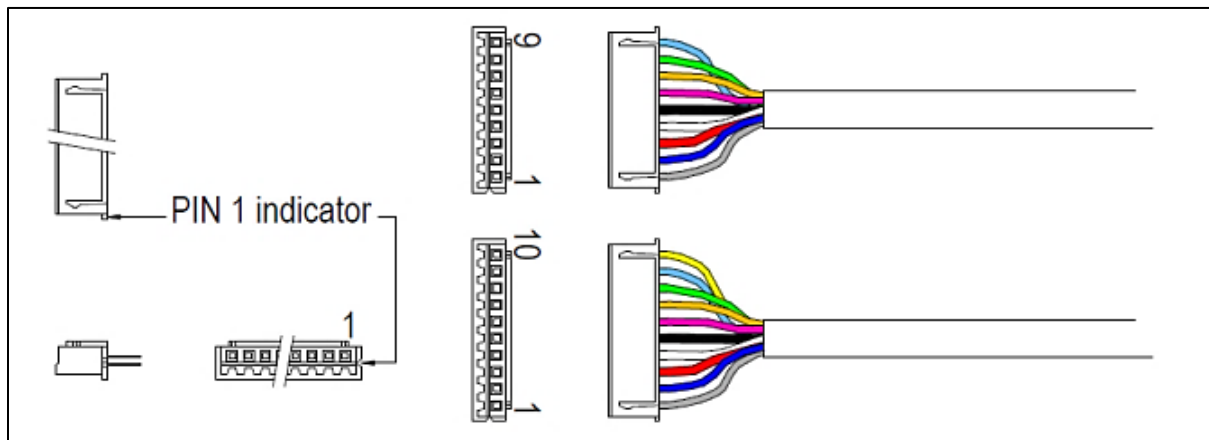

14.3.3 HB-510 Installation Precautions

Precaution	Action	Reason
<p>More than 30 cards connected together with the CAT5E communication cable</p>	<p>The first card after each set of 30* must be set as follows:</p> <p>DIP Switch 1-1: OFF</p> <p>DIP Switch 1-2: OFF</p> <p>DIP Switch 1-3: OFF</p> <p>*Standard conveyor configuration; starting with first upstream card. If using ERR, DIR or ESTOP, signal must be connected to each group of 30 cards.</p>	<p>When a card has its ERR, DIR or ESTOP signal activated, that signal is communicated through the CAT5E cable by sinking the signal. Each card's circuitry must be able to handle the current sourced by other cards on the chain. More than 30 cards will exceed the current limit and damage the printed circuit boards.</p>
<p>Powering ON</p>	<p>Maintain safe distance from the system when powering on, as equipment will start automatically.</p>	<p>When the system is first powered on, a 5-7 second startup cycle will initiate. Unoccupied zones will run at a slow speed to advance articles which may be between photo-sensors (Seek to Sensor function). After this, occupied zones will start running if there are open downstream sensors.</p>
<p>Low impedance connection to PNP output(s)</p>	<p>DO NOT connect an output terminal (CN2-4, CN2-5) set for PNP directly to 0V, GND, or a low impedance input on a controller.</p>	<p>When the PNP signal is active, the low impedance input will draw a high current, potentially damaging both the driver card and the controller.</p>
<p>Multiple power supplies</p>	<p>0V line of all power supplies associated with a conveyor "unit" (cards, rollers, and external controls) need to be connected.</p>	<p>This completes the signal path between conveyor sections and system controls.</p>
<p>Voltage drop across power bus</p>	<p>Use suitable gauge wire in relation to distance and current draw.</p>	<p>Voltage must not drop below 21.6V DC or voltage faults will occur.</p>

14.3.4 HB-510 User Interface Switch Settings

Signal Block Settings						
DIP Switch	Function	On		Off		Default Setting
		CN5 (Left)	CN4 (Right)	CN5 (Left)	CN4 (Right)	
1-1	ERR signal transmission	Transmit & Receive	Transmit & Receive	Transmit & Receive	Blocked	ON
1-2	DIR signal transmission				Blocked	ON
1-3	ESTOP signal transmission				Blocked	ON
1-4	SPEED signal transmission Left (Downstream)		n/a	Blocked	n/a	ON
1-5	SPEED signal transmission Right (Upstream)	n/a	Transmit & Receive	n/a	Blocked	ON

Input / Output Settings					
DIP Switch	Function	ON	OFF	Default Setting	
1-6	SPEED adjustment	External: 0-10V DC	Internal: Rotary switch	OFF	
1-7	DIR or ESTOP input (CN2-2)	ESTOP signal input	DIR signal input	OFF	
1-8	Reset for thermal recovery	Manual input recover	Automatic recover	ON	
2-1	Output signal type (CN2-4 & CN2-5)	PNP signal output	NPN signal output	ON**	
2-2	Sensor or Synchronous output (CN2-4)	Output is active (+24V) while internal motor RUN signal is ON.	Output is active (+24V) while photo-sensor (CN3-2) signal is ON.	ON	
2-8	STOP or RUN input (CN2-1)	RUN signal input	STOP signal input	ON	
<p>Timer Settings – Allows card timers to be adjusted for fast (single stage) down to slow (three stage) rollers, default setting is for two stage. Also can be used to lengthen run timers for long (>36”) zones.</p>					
Dip Switch		Gear Stages	Time (seconds)		
2-3	2-4		Sensor Timer	Run Hold Timer	Jam Timer
OFF	OFF	1	0.3-1.2	0.3-1.2	0.6-2.2
OFF (Default)	ON (Default)	2	1.0-4.0	1.0-4.0	2.0-8.0
ON	OFF	3	4.0-14.0	4.0-14.0	7.5-27.0
ON	ON	n/a	Motor runs continuously; for trouble shooting only		

Other Settings						
DIP Switch	Function	ON		OFF		Default Setting
2-5	Release modes	ZP1 Train/Slug release		ZP2 Singulated release		ON
2-6	Last zone mode	ZB Standard zone		ZE Last (discharge) zone		ON
2-7	Motor direction*	FE	FS/FP	FE	FS/FP	ON
		CCW	CW	CW	CCW	

*Motor direction (as viewed from the cable side; PM486 series) is independent of ZPA logic flow direction.

Notes:

- Table based on PM486FE-60 roller
- See Roller Performance Tables for additional card/roller speed combinations
- When using an analog signal for external speed control, note that roller speed selections are in fixed increments and not infinitely adjustable.

14.3.5 HB-510 LED's and Error Indications

Status	LED1 (green)	LED2 (orange)	LED3 (red)	ERR Signal (CN2-5)	Error Condition	Result	Solution*
Normal	● (ON)		○	● (ON)	n/a	n/a	n/a
	Blinks (1Hz) ● ○ while running		(OFF)	(ON)			
Thermal overload		● (ON) When sensor signal is ON	● (ON)	○ (OFF)	Motor or PCB above operating temperature	No operation	1
Motor lock	● (ON)		Blinks (1Hz) ● ○	● (ON)	Motor locked (>4s)		2
Motor unplugged	(ON)		● (ON)		Motor not connected to card		3
JAM error		Blinks (1Hz) ● ○	○ (OFF)	○ (OFF)	Jam Timer activated		4
Open fuse Low voltage	○ (OFF)	●	Blinks (1Hz) ● ○		Low voltage or current exceeded 5A		5
Current limit	Blinks (1Hz) ● ○ while running	(ON) When sensor signal is ON	Blinks (6Hz) ●●●●●● ●●●●●●	● (ON)	High current draw	n/a	6

Solution

1. See more information under Input / Output Settings, DIP switch 1-8
 - A signal applied to CN2-1 (INPUT) will reset this error status
 - Thermal overload can only be reset if the temperature has fallen back into the operating range
2. Remove the cause of the motor lock and clear the zone
 - A signal applied to CN2-1 (INPUT) AND DIP switch 2-8 set to ON (RUN) will reset this error status

3. Remove power from the card, plug in the motor connector, and then reapply power
4. Remove the cause of the jam and clear the zone
 - A signal applied to CN2-1 (INPUT) will reset this error status
 - As long as a signal is applied to CN2-1, jam error status will not turn ON
5. Replace the card
6. Not usually a cause for concern, unless it is occurring frequently over the entire running cycle

14.3.6 HB-510 Drivercard speed chart

HB-510 DRIVERCARD / FP-___ ROLLER											
ROLLER: FE-17			ROLLER: FE-60			ROLLER: FE-100			ROLLER: FE-140		
MHS NOMINAL SPEED	ROTARY SWITCH	ACTUAL SPEED ± 5% (fpm)	MHS NOMINAL SPEED	ROTARY SWITCH	ACTUAL SPEED ± 5% (fpm)	MHS NOMINAL SPEED	ROTARY SWITCH	ACTUAL SPEED ± 5% (fpm)	MHS NOMINAL SPEED	ROTARY SWITCH	ACTUAL SPEED ± 5% (fpm)
13	0	13.8	45	0	49.2	170	0	174.8	170	0	174.9
18	1	18.4	65	1	65.6	230	1	232.9	230	1	233.2
20	2	23	80	2	82		2	290.3/(239.4)	290	2	291.4
25	3	27.6	95	3	98.4		3	349.3/(239.4)	345	3	349.7
30	4	32.5	110	4	114.8		4		405	4	408.2
35	5	37.1	130	5	131.2	235	5			5	466.3/(419.8)
40	6	41.7	145	6	147.6		6	407.4/(239.4)		6	524.7(419.8)
45	7	46.3	160	7	164		7		415	7	
	8	50.9/(49.9)	180	8	180.4/(176.8)		8			8	566.2/(419.8)
50	9	55.3/(49.9)		9	196.8/(176.8)		9			9	

Note: Speed with two numbers are " NO-LOAD / RATED". Rated numbers are what the roller is capable of doing under a continuous duty full load condition.

HB-510 DRIVERCARD / FP-___ ROLLER								
ROLLER: FP-55			ROLLER: FP-100			ROLLER: FP-140		
MHS NOMINAL SPEED	ROTARY SWITCH	ACTUAL SPEED ± 5% (fpm)	MHS NOMINAL SPEED	ROTARY SWITCH	ACTUAL SPEED ± 5% (fpm)	MHS NOMINAL SPEED	ROTARY SWITCH	ACTUAL SPEED ± 5% (fpm)
50	0	53.5	240	0	243	240	0	243.4
70	1	71.2		1	324.1/(259.1)	320	1	324.5
85	2	88.9		2		405	2	405.4
105	3	106.9		3			3	486.6/(478.2)
120	4	124.6		4			4	567.7/(478.2)
140	5	142.4	255	5	404.8/(259.1)		5	
160	6	160.4		6		475	6	
175	7	178.1		7			7	627.1/(478.2)
	8	195.8/(181.1)		8			8	
180	9	204.3/(181.4)		9			9	

Note: Speed with two numbers are " NO-LOAD / RATED". Rated numbers are what the roller is capable of doing under a continuous duty full load condition.

ITRHB General Information

See Itoh-Denki technical document for additional information: <http://itohdenki.com/>

14.3.7 HB-510 Start Kit

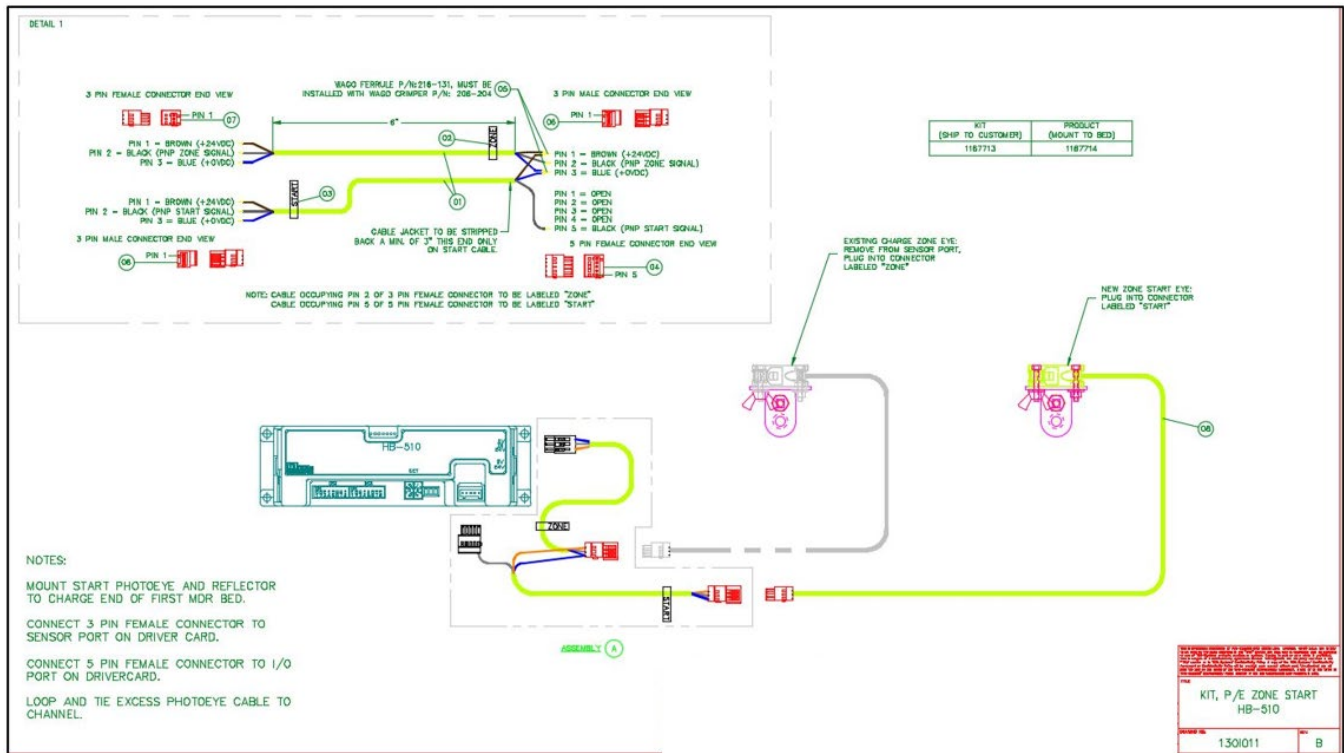

14.3.7.1 Replacement Parts - HB-510 Photoeye Kit

General Photoeye Cables & Kit				
Balloon	Item #	Description	Mounted	DWG #
1 - 8	1167713	KIT,P/E ZONE START HB-510	FIELD MOUNTED	130I011

14.4 ACCUMULATION CHARGE ZONE PRESSURE SWITCH ASSEMBLY

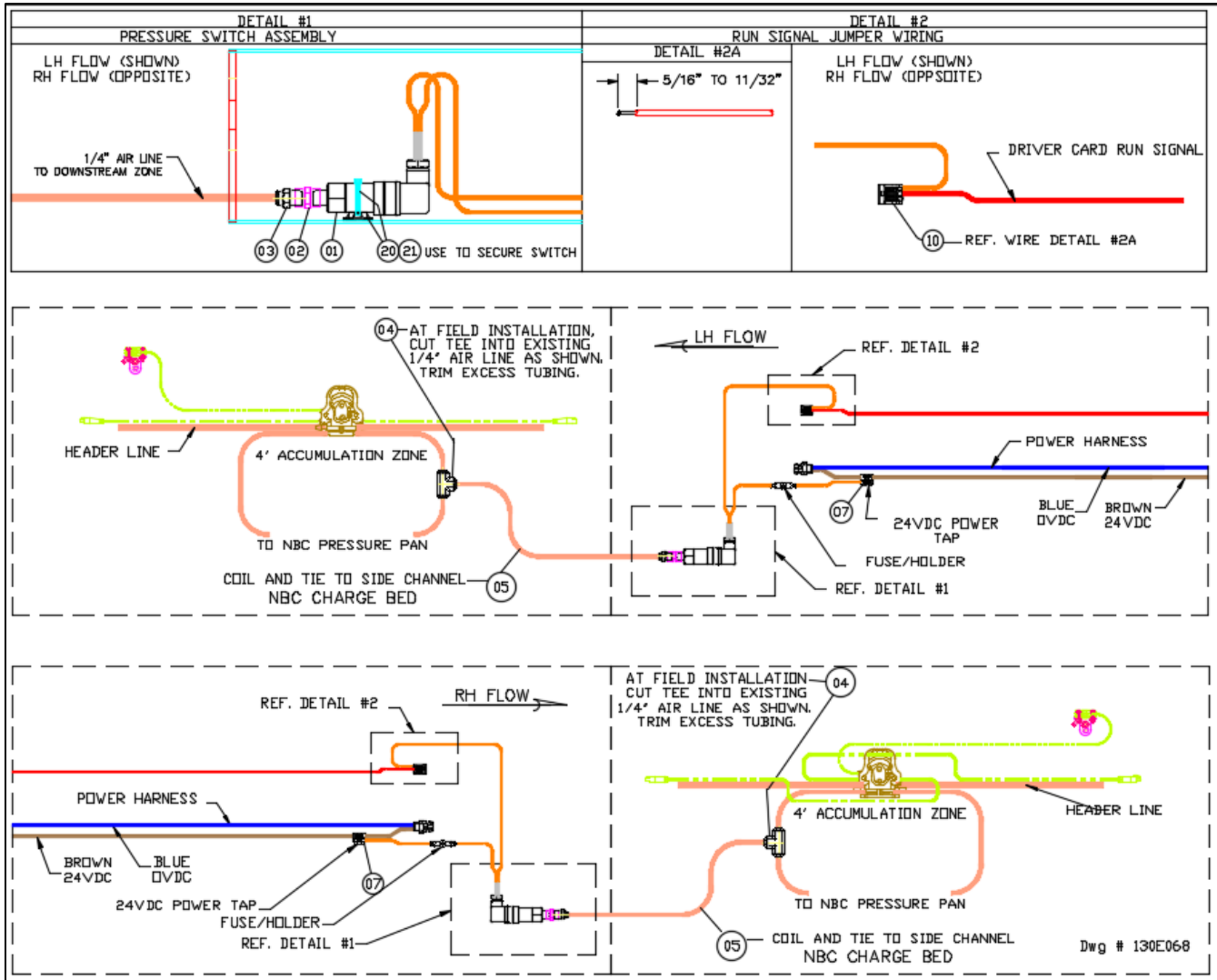

14.4.1 Replacement Part - Pressure Kit, CB to NBC

Pressure Switch Kit, CB to NBC				
Balloon	Item #	Description	Mounted	DWG #
ALL	1152711	KIT, ITR-PRSS SWTCH-CB TO NBC	FIELD MOUNTED	130E068

14.6 DISCHARGE LOGIC CTRL PRESSURE SWITCH KITS

14.6.1 Discharge Logic Control Left Hand

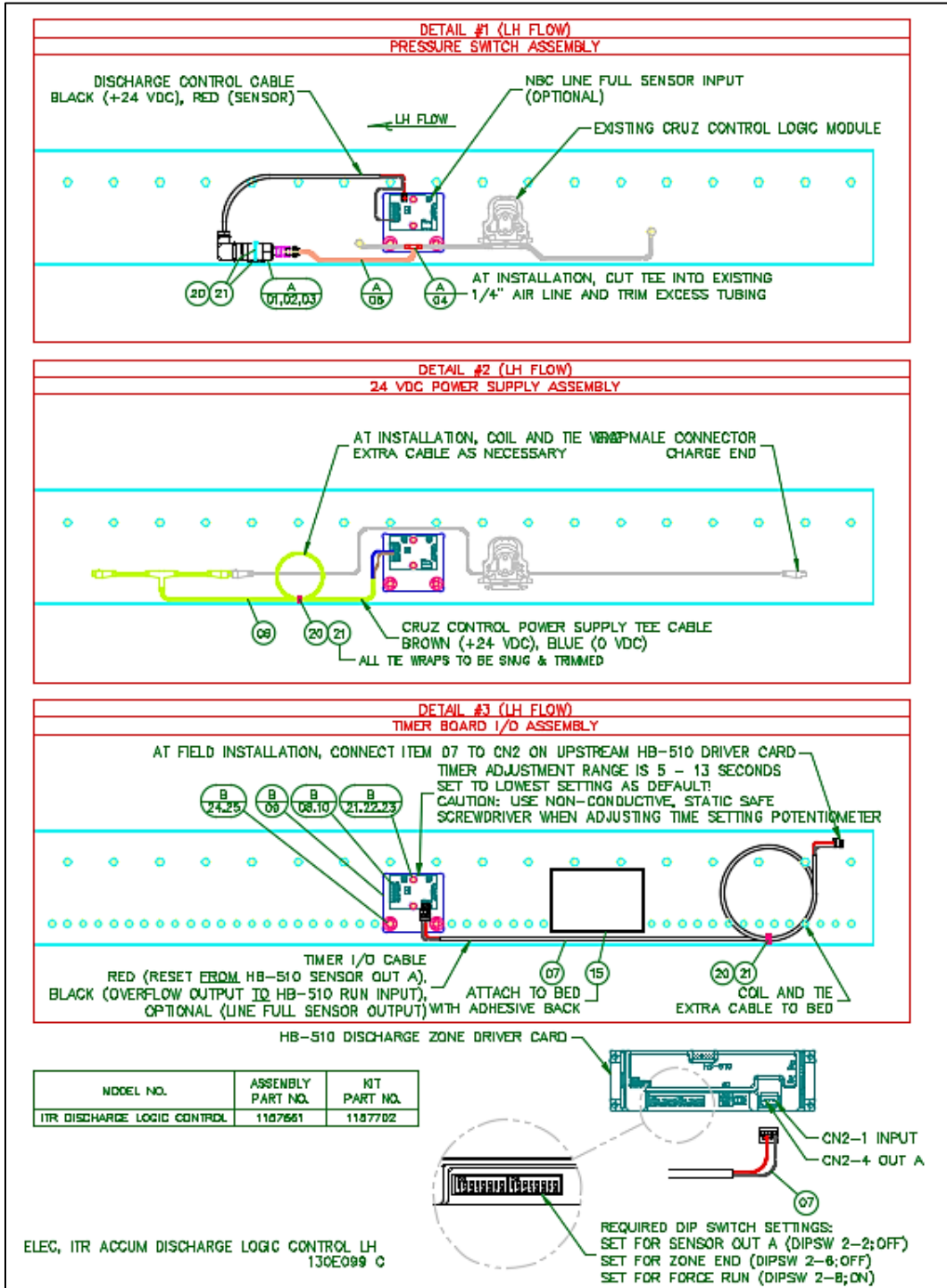

14.6.2 Discharge Logic Control Right Hand

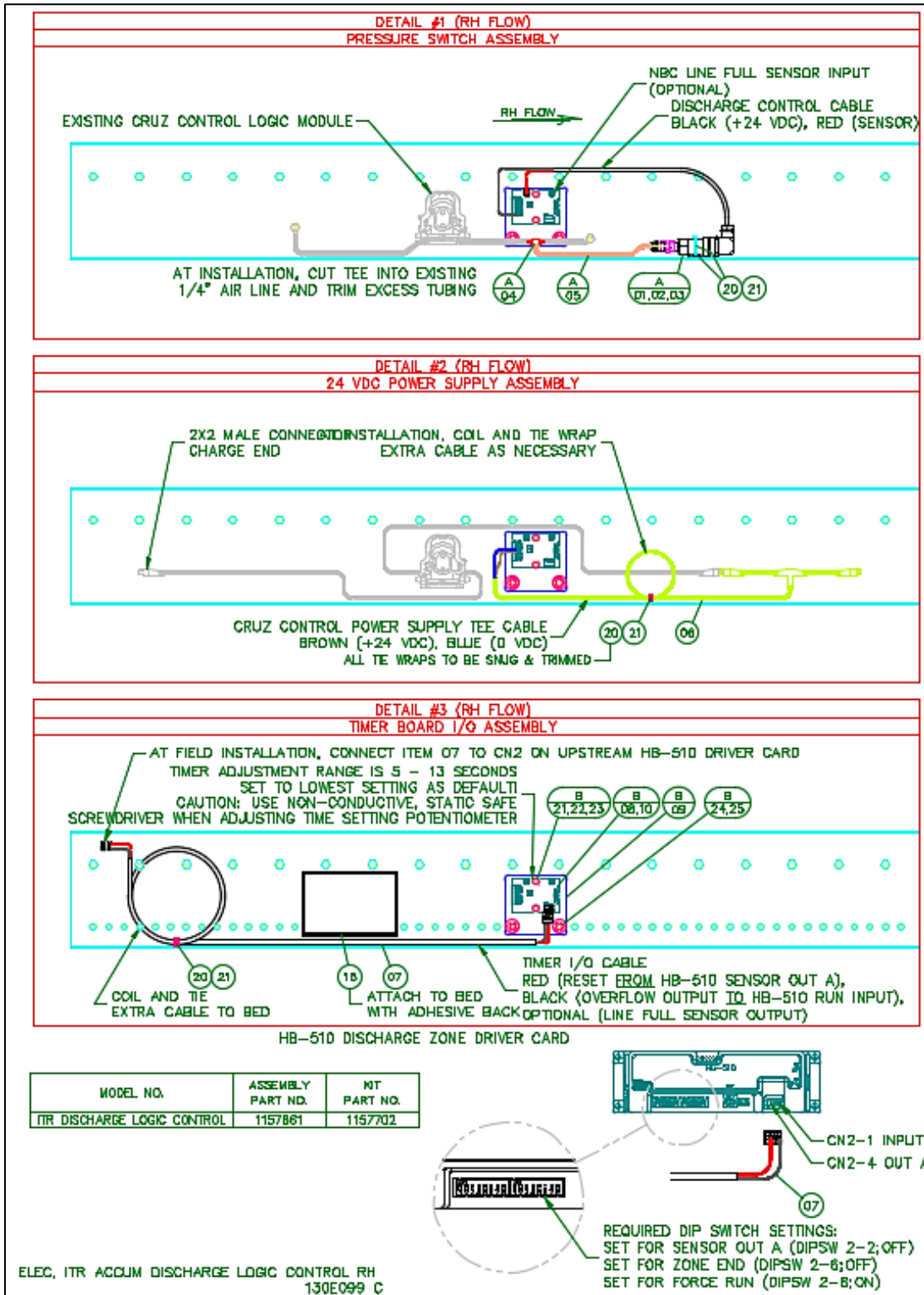

14.6.2.1 Replacement Part - Pressure Switch Kits, HB to NBC

Accumulation Discharge Logic Control LH / RH Pressure Switch Kit,HB to NBC				
Balloon	Item #	Description	Mounted	DWG #
All	1157702	KIT,ITR-PRSS SWTCH-HB TO NBC	FIELD MOUNTED	130E099

15.3 IB-E03 OPERATING ENVIRONMENT

Conditions		Notes
Ambient temperature	-20 to 40 °C (-4 to 104 °F)	No condensation, water, frost, or ice
Humidity	≤ 90% Relative Humidity	
Atmosphere	No corrosive gas	
Vibration	≤ 1.0G	
Installation	Indoor	
Pollution level	2	Conforming to IEC60640-1 and UL840
Overvoltage category	2	

15.4 IB-E03 POWER REQUIREMENTS

Item	Specification
<ul style="list-style-type: none"> Input Power 	<ul style="list-style-type: none"> 24V DC (+/- 5%)
<ul style="list-style-type: none"> Typical Loaded Current Draw Per Motor* for IB-E01 and IB-E03B 	<ul style="list-style-type: none"> 2 ~ 3A – Motor A 2 ~ 3A – Motor B
<ul style="list-style-type: none"> Maximum Current Draw Per Motor For IB-E01 and IB-E03B 	<ul style="list-style-type: none"> 4A – Motor A 4A – Motor B
<ul style="list-style-type: none"> Typical Loaded Current Draw Per Motor* for IB-E04F 	<ul style="list-style-type: none"> 3 ~ 4A – Motor A 3 ~ 4A – Motor B
<ul style="list-style-type: none"> Maximum Current Draw Per Motor for IB-E04F 	<ul style="list-style-type: none"> 7A – Motor A 7A – Motor B
<ul style="list-style-type: none"> Maximum Current Draw Per Remote (Auxiliary) Output 	<ul style="list-style-type: none"> 1A – Remote output 1 1A – Remote output 2 20mA – Remote output 3 20mA – Remote output 4 20mA – Remote output 5

* Actual current draw is dependent on load (size and weight) and motorized roller model used.

Note: The Remote (Auxiliary) Outputs are isolated from the IB-E power. Therefore, a separate 24V DC power source may be used. If not, the Remote Output current draw should be factored into the IB-E's overall current draw when used.

15.5 IB-E03 APPLICABLE POWER ROLLERS (MOTORIZED ROLLERS)

IB-E01 and IB-E03B

Standard*	With Brake Option
PM486FE	PM486FE-BR
PM486FS	PM486FS-BR
PM486FP	PM486FP-BR
PM570FE	PM570FE-BR
PM605FE	PM605FE-BR
PM635FS	PM635FS-BR

* IB-E01 and IB-E03B are designed to work with both our standard models and brake models. The (mechanical) brake option requires a 10th pin for the brake coil. Therefore, standard model rollers will need to have either a 10-pin connector on the motor cable or a 9-to-10-pin extension cable.

15.6 IB-E03 ELECTRICAL COMPONENTS

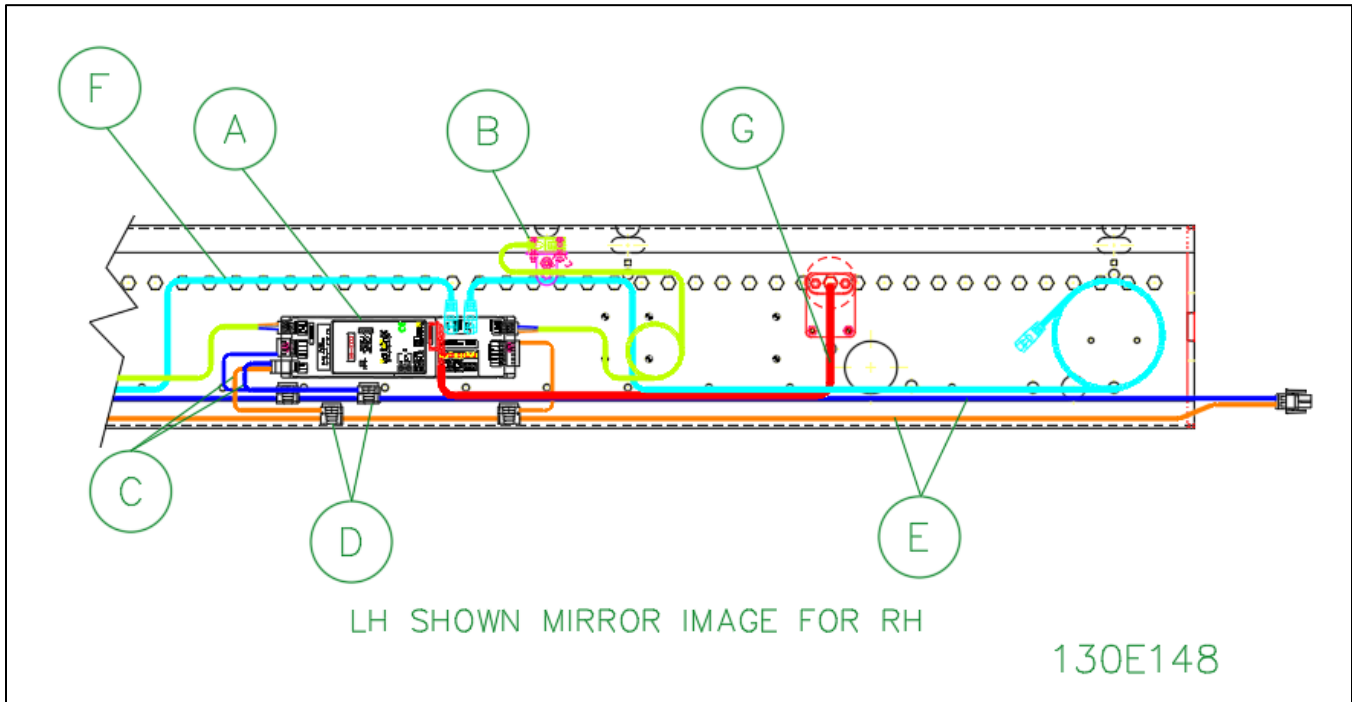

- A. IB-E03 driver card (includes hardware, no connectors): P/N 1166288
- B. Photoeye (ZL PNP light op-2000mm lead w/733-104 w/reflector & tape): P/N 1164882
- C. Cable, Power IB-E03 (for short distances < 6"): P/N 1165236
- D. Scotchlok Connectors (connect power tap to power harness): P/N 3M567
- E. Power Harness: See Table 1.
- F. Cat5E Communication Cable: See Table 2.
- G. Cable, Motor Extension: See Table 3.

Table 1 IB-E03 Power Harness

Item No.	Description
1129502	HARNESS, ITR-POWER-10AWG-12.5'
1102286	HARNESS, ITR-POWER-10AWG-10.5'
1102287	HARNESS, ITR-POWER-10AWG-8'
1102288	HARNESS, ITR-POWER-10AWG-5.5'
1102289	HARNESS, ITR-POWER-10AWG-3'

Table 2 Communication Cables

Item No.	Description
E0034025	CABLE, CTRLS-CAT5E-3'-GRAY
E0034026	CABLE, CTRLS-CAT5E-5'-GRAY
E0034027	CABLE, CTRLS-CAT5E-7'-GRAY
E0030796	CABLE, CTRLS-CAT5E-10'-GRAY
E0009905	CABLE, CTRLS-CAT5E-14'-GRAY
E0009904	CABLE, CTRLS-CAT5E-25'-GRAY

Table 3 - Cable Motor Extensions

Item No.	Description
1135339	CABLE, MOTOR EXTENSION, 600MM ITOH M-F-EXT-10PIN-600 USE W/ IB-N03/IB-E/HBM-604/BRAKE
1135340	CABLE, MOTOR EXTENSION, 1200MM ITOH M-F-EXT-10PIN-1200 USE W/ IB-N03/IB-E/HBM-604/BRAKE
1135341	CABLE, MOTOR EXTENSION, 1200MM ITOH M-F-EXT-10PIN-1200 USE W/ IB-N03/IB-E/HBM-604/BRAKE

15.6.1 IBE Photoeye Cable Kit

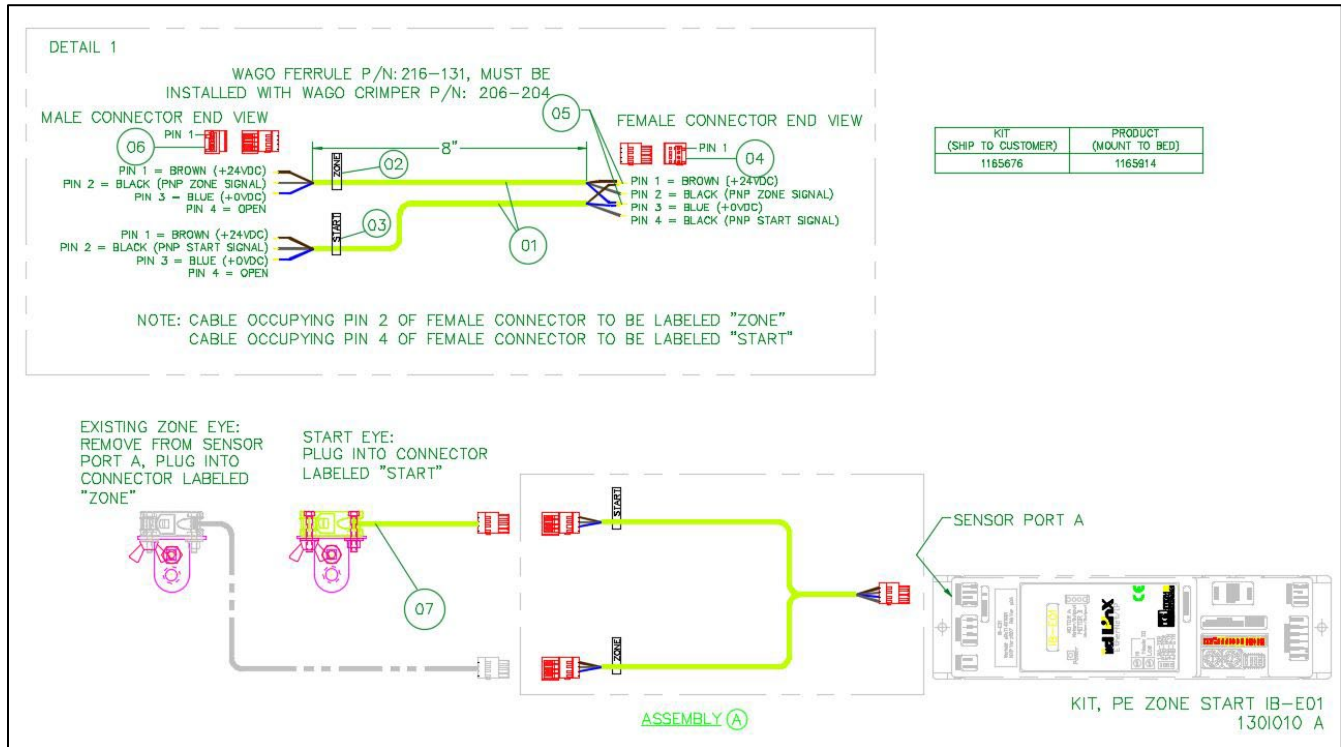





15.6.2 Replacement Parts - IB-E03 Photoeye Kit

General Photoeye Cables & Kit				
Balloon	Item #	Description	Mounted	DWG #
1 - 6	1165676	KIT,CTRLS-PE ZONE START-IBE	FIELD MOUNTED	130I010

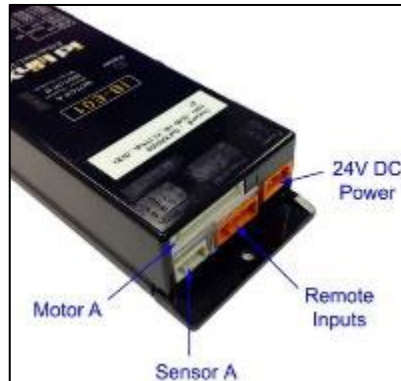
15.7 IB-E03 HARDWARE CONNECTIONS



Left (“A”) Side

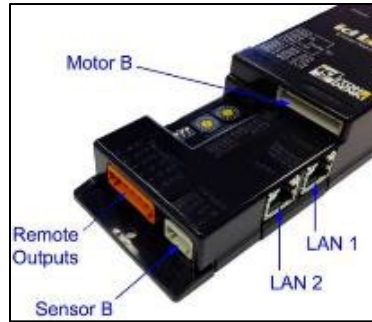

Connection	Pin Outs	Description
Motor A	 1 10	Brushless DC Driver When configured as a discrete output (NPN, sinking, only): 3 – Discrete output U (IB-E04F pins 3 & 4) 4 – Discrete output V (IB-E04F pins 5 & 6) 5 – Discrete output W (IB-E04F pins 7 & 8) See “Precaution: Motor Port Discrete Output Wiring” below. Connector for wiring: JST XHP-10 (IB-E04F XHP-12) Included with motorized roller
Sensor A	 1 4	1 – 24V DC (550mA max) 2 – Sensor input (35mA max) 3 – 0V 4 – Sensor alarm input (35mA max) IB-E01: Inputs are auto-sensing, responding to either PNP (+24V DC) or NPN (0V) signals. In the normal state, the input pins have a +12V DC reference. IB-E03B and IB-E04F: Signal types are set as PNP or NPN from factory. Noted as a “-P” or “-N”, respectively (e.g. IB-E03B-P) Connector for wiring: WAGO 733-104
Remote Inputs (Auxiliary)	 1 4	1 – Remote input 1 2 – Remote input 2 3 – Remote input 3 4 – Common (24V DC for NPN or 0V for PNP) Connector for wiring: WAGO 734-204
24V DC Power	 1 2	Input Power 1 – 0V 2 – 24V DC Connector for wiring: WAGO 231-302/026-000

Right (“B”) Side

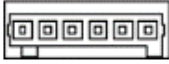
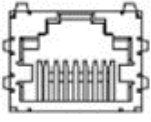

Connection	Pin Outs	Description
Motor B	 1 10	Brushless DC Driver When configured as a discrete output (NPN, sinking, only): 3 – Discrete output U (IB-E04F pins 3 & 4) 4 – Discrete output V (IB-E04F pins 5 & 6) 5 – Discrete output W (IB-E04F pins 7 & 8) See “Precaution: Motor Port Discrete Output Wiring” below. Connector for wiring: JST XHP-10 (IB-E04F XHP-12) Included with motorized roller
Sensor B	 1 4	1 – 24V DC (550mA max) 2 – Sensor input (35mA max) 3 – 0V 4 – Sensor alarm input (35mA max) IB-E01: Inputs are auto-sensing, responding to either PNP (+24V DC) or NPN (0V) signals. In the normal state, the input pins have a +12V DC reference . IB-E03B and IB-E04F: Signal types are set as PNP or NPN from factory. Noted as a “-P” or “-N”, respectively (e.g. IB-E03B-P) Connector for wiring: WAGO 733-104
Remote Outputs (Auxiliary)	 1 6	1 – Remote output 1, 1A max 2 – Remote output 2, 1A max 3 – Remote output 3, 20mA max 4 – Remote output 4, 20mA max 5 – Remote output 5, 20mA max 6 – Common (24V DC for PNP or 0V for NPN) Connector for wiring: WAGO 734-206
LAN (1 & 2)	 8 1	1 – Tx + 2 – Tx - 3 – Rx + 4 – n/a 5 – n/a 6 – Rx - 7 – n/a 8 – n/a Connector for wiring: RJ-45

15.8 IB-E03 ROTARY SWITCHES AND DIP SWITCHES

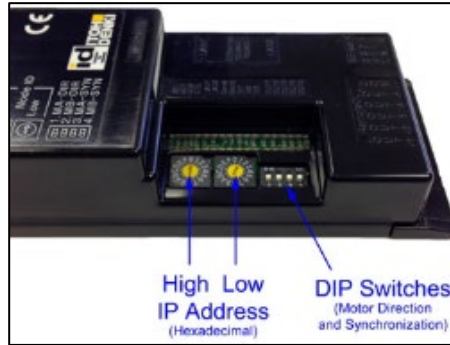

Switch	Position	Description
IP Address High Byte	0 ~ F	Hexadecimal setting of IP address' last octet. 192.168.1.xxx Example 1: High Byte: "0" Low Byte: "1" Hexadecimal value "01" = 1 (decimal) IP Address: 192.168.1.1
IP Address Low Byte	0 ~ F	
DIP 1	OFF	Default
	ON	Motor A's direction is opposite of configuration, reversed
DIP 2	OFF	Default
	ON	Motor B's direction is opposite of configuration, reversed
DIP 3	OFF	Default
	ON*	Motor A operates when Motor B operates, synchronized
DIP 4	OFF	Default
	ON*	Motor B operates when Motor A operates, synchronized

* If both DIP switch 3 and 4 are ON, the IB-E is set to factory reset mode. Refer to troubleshooting section for more information.

15.9 IB-E03 IP ADDRESS SUBNET

Default: 192.168.1.xxx

If a different subnet for the IP address is needed, different from the default 192.168.1.xxx, it can be changed using the Itoh Configurator for EtherNet/IP (ICE).

IP Address Setting (Last Octet)

The rotary switches set the last octet of the IB-E's IP address. There are 16 positions (hexadecimal base) for each rotary switch.

The following table is available to assist in determining the decimal equivalent of the hexadecimal rotary switch positions.

High Byte		+	Low Byte	
Position	Base Decimal Value		Position	Base Decimal Value
0	0		0	0
1	16		1	1
2	32		2	2
3	48		3	3
4	64		4	4
5	80		5	5
6	96		6	6
7	112		7	7
8	128		8	8
9	144		9	9
A	160		A	10
B	176		B	11
C	192		C	12
D	208		D	13
E	224		E	14
F	240		F	15

Using the decimal values, the last octet can be calculated.

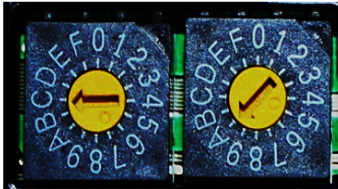

Base	High Byte	+	Low Byte	=	Last Octet
Hexadecimal	C				A
Decimal	192		10		202

LED Indicators

See troubleshooting.

15.10 IB-E03 MODULE STATUS INDICATORS

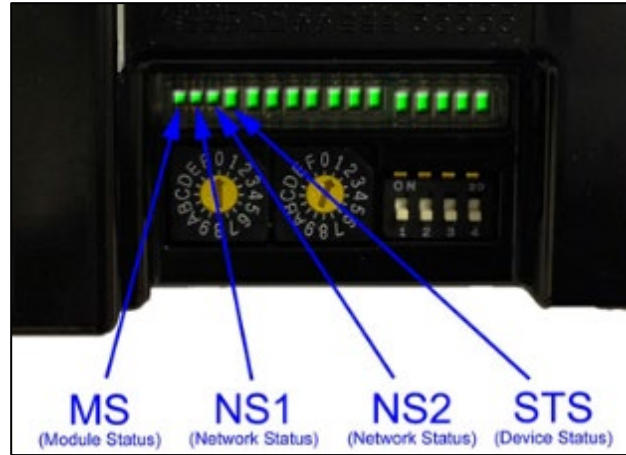

LED	LED indication pattern		Description
	Green	Red	
MS	OFF	OFF	No network power
	ON	OFF	Normal operation
	ON	Flash (1Hz)	No setting on device
	OFF	Flash (1Hz)	Network error at LAN 1 or LAN 2
	OFF	ON	Network error at LAN 1 and LAN 2
	Flash (1Hz)	Flash (1Hz)	Boot up sequence
NS1 & NS2*	OFF	OFF	No communication
	Flash (1Hz)	OFF	Normal operation
	ON	OFF	I/O connection
	OFF	Flash (1Hz)	I/O connection timeout error
	OFF	ON	Duplicate IP address error
	Flash (1Hz)	Flash (1Hz)	Boot up sequence
STS	ON	-	Power ON Network PCB
	Flash (6Hz)	-	Low voltage (< 20V DC) error
	Flash (1Hz)	-	Firmware updating
	OFF	-	No power on network PCB

* NS2 is only on the IB-E01

15.11 IB-E03 LAN AND SENSOR STATUS INDICATORS

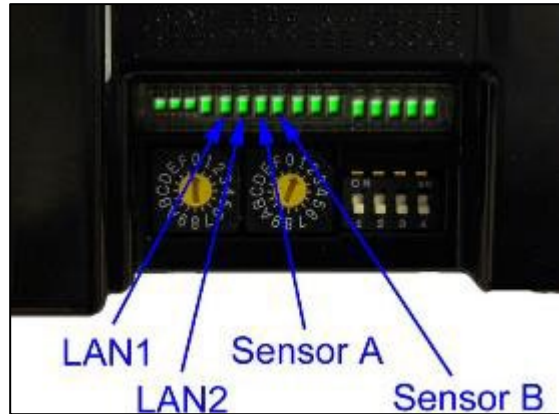

LED	LED indication pattern		Description
	Green	Red	
LAN1 & LAN2	Flash	-	Active LAN communication
	OFF	-	No LAN communication
SenA & SenB	ON	-	Sensor input is active
	OFF	-	No sensor input

15.12 IB-E03 REMOTE (AUXILIARY) I/O STATUS INDICATORS

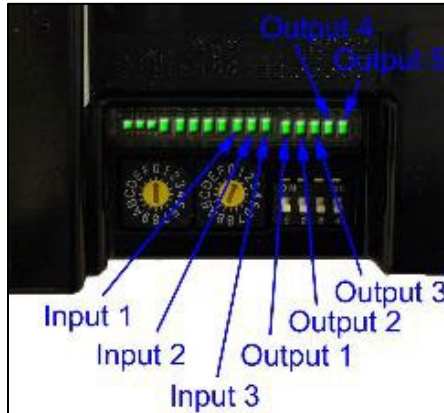

LED	LED indication pattern		Description
	Green	Red	
IN1 ~ IN3	ON	-	Remote input is active
	OFF	-	No remote input
OUT1 ~ OUT5	ON	-	Remote output is active
	OFF	-	No remote output

15.13 IB-E03 MOTOR ACTIVITY AND FUNCTION INDICATORS

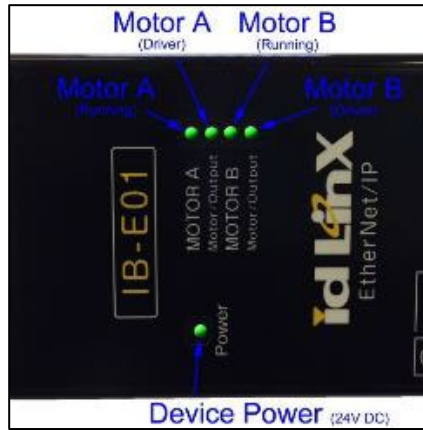

LED	LED indication pattern		Description
	Green	Red	
Power	ON	-	Normal, power is on
	OFF	-	No power to device
Motor/Output	ON	-	24V brushless DC driver
	OFF	-	Discrete outputs
MOTOR A & MOTOR B	OFF	OFF	Motor is not running
	Flash (1Hz)	OFF	Motor is running, CW
	ON	OFF	Motor is running, CCW
	OFF	Flash (6Hz)	Low voltage error
	OFF	Flash (1Hz)	Motor unplugged error
	ON	Flash (1Hz)	Motor lock error
	OFF	ON	Thermal error
	ON	2 x Flash (0.6Hz)	Back EMF error
	Alternating (1Hz)		JAM error*
Alternating (6Hz)		Sensor Timer error*	

16 IB-E03 TROUBLESHOOTING – MOTOR DRIVER

Error Type	Priority	Suspected Cause	Suggested Solution	Reset Method	IB-E Logic	Motor
Low Voltage	1	Supply voltage < 20V DC	Maintain supply voltage ≥ 20V DC	Automatic	Stop	Stop
Fuse blown		Fuse is blown	Replace IB-E	-		
Motor Disconnected	2	Motor is not connected	Connect motor	Automatic or Manual	Run	
Motor Stalled	3	Motor does not turn (stalled)	Clear the issue which prevents the motorized roller from turning	Automatic* or Manual		
PCB Thermal	4	High temperature on circuit board	Allow circuit board to cool	Automatic or Manual		
Motor Thermal	5	High temperature in motor	Allow motor to cool	Automatic or Manual		
Back EMF (Over-speeding)	6	Generated voltage from motor ≥ 60V DC, at least 0.1 second or ≥ 40V DC, at least 2 seconds	Remove the cause of over speeding, then reset the error from the controller or by cycling 24V DC power	Manual		
Motor port (discrete output) current limit		≥ 4A, at least 0.1 second	Remove the cause for the high current draw	Manual		
Jam	7		Remove the cause of error or review ICE logic for output conditions	Based on logic conditions	Based on logic conditions	
Sensor Timer	8	ICE logic element output is active				
Sensor Alarm	9	Occurs when the (sensor) Alarm signal is active	Check the sensor or wiring of the sensor connection	Automatic		

“Automatic” reset from a motor stalled error requires the motorized roller to be turned by hand (manually).

Error Reset - Refer to - Error Information to reset error status using ICE.

16.1 IB-E03 PHYSICAL BEHAVIOR

The motorized roller is not running at the set (linear/surface) speed.

- Check the “Motor” tab under properties for the following:
 - Gear Reduction setting matches the correct motorized roller model
 - Speed setting is for the correct time base
 - Roller Diameter is set correctly for millimeters
 - Roller Speed(s) are set correctly and that the logic is using the correct speed setting output
- Check input power (refer to Chapter 1 – Power Requirements)
- Make sure the motorized roller is mounted properly

The motorized roller is running in the wrong direction.

- Check “Motor” tab under properties for the following:
 - Motor Type setting matches the correct roller model
 - Direction is set for the correct default motor direction
- Check DIP switch 1 and/or 2 (refer to – [Rotary Switches and DIP Switches](#))
- Check that the logic is using (or not using) the motor direction output

The motorized roller does not run.

- Make sure “Motor Port Setting” in the “Motor” tab under properties is set as “Motor”
- Check that the logic is using the correct motor output
- Check the status LEDs on the IB-E (refer to – [LED Indicators](#))
- Check DIP switch 3 and/or 4 (refer to – [Rotary Switches and DIP Switches](#))
- Make sure the motorized roller is mounted properly

There is no response to the sensor input.

- Make sure the sensor is powered
- Make sure the sensor is wired correctly (refer to Chapter 1 – Hardware connections)
- Check the status LEDs on the IB-E (refer to – [LED Indicators](#))
- Check the logic for the correct sensor input

There is no response to the remote (auxiliary) input.

Make sure the input (device) and common are wired correctly (refer to – [Hardware connections and – General Wiring and Precautions](#))

- Check the status LEDs on the IB-E (refer to – LED Indicators)
- Check the logic for the correct remote input

The remote (auxiliary) output does not turn on.

- Make sure the output (device) and common are wired correctly (refer to – Hardware connections and – General Wiring and Precautions)
- Check the status LEDs on the IB-E (refer to – LED Indicators)
- Check the logic for the correct remote output

The Discrete Output from the motor port does not work.

- Make sure “Motor Port Setting” in the “Motor” tab under properties is set as “Port(Nch)”
- Make sure the output is wired correctly (refer to – Hardware connections and – General Wiring and Precautions)
- Check the status LEDs on the IB-E (refer to – LED Indicators)
- Check the logic for the correct discrete motor port output

16.2 IB-E03 SOFTWARE ISSUES

Read/write (configuration or logic) failure

- Check the IP address settings on the IB-E (refer to – Rotary Switches and DIP Switches)
- Check the IP address setting in ICE (refer to – Project Tree)
- Check the PC’s IP address (refer to – Property Setting)
- Check the PC’s firewall settings (refer to – Windows Firewall)
- Make sure the IB-E has had enough time to reboot between consecutive writes/downloads.

Monitor not responding to status changes

- Check the IP address settings on the IB-E (refer to – Rotary Switches and DIP Switches)
- Check the IP address setting in ICE (refer to – Project Tree)
- Check the PC’s IP address (refer to – Property Setting)
- Check the PC’s firewall settings (refer to – Windows Firewall)
- Make sure the IB-E has had enough time to reboot between consecutive writes/downloads.

16.3 IB-E03 MODULE RESET

The module can be reset to factory defaults. Normally, this is not necessary.

16.1 Power OFF the IB-E, set both rotary switches to “0”, set DIP switches 1 and 2 to the OFF position, and set DIP switches 3 and 4 to the ON position.



16.2 Power ON the IB-E and wait for the central LED indicators to light up.

16.3 Power OFF the IB-E and set the rotary switches and the DIP switches to the previous (or other operational) settings.

16.4 Power ON the IB and use as normal.

See Itoh-Denki IB-E and ICE Manual for additional information: <http://itohdenki.com/>

17 ITR MAINTENANCE & TROUBLESHOOTING

General Preventive Maintenance



Preventive maintenance will save expensive downtime, wasted energy costs, and increase life of components. An accurate record keeping system will track component servicing history. Periodic maintenance intervals may vary with load, speed, hours of operation, ambient temperature, humidity, etc. Intervals can be established by fairly frequent maintenance at first, and then lengthens the intervals as justified by observation of need based on history. The following schedule is based on 5 days per week, 8 hours per day operation under normal conditions.

Daily

- Listen to everything for unusual noises or vibration.
- Visually inspect to see that conveyor sections are clear and free of debris.
- Check to see that all safety guards are in place.
- Check for loose bolts or parts.
- Listen for air leaks.

Weekly



- Check for proper PSI on air regulators.
- Check air filter bowls for accumulated water.

 WARNING	
	<ul style="list-style-type: none">• Prohibit walking or riding on conveyor by anyone.• Care should be taken when servicing any conveyor to prevent accidental injury.• All moving parts are potentially dangerous.

Air Systems

The best preventive maintenance for any air operated device is clean air. Dirty air will make pneumatic devices sticky, and they will not operate properly. To ensure the continued performance of filters, monitor filter / regulator bowl drain every week.

To manually drain the bowl, push the push button at the bottom of the bowl. Let all accumulated liquid drain until you hear air escaping.

 WARNING	
	<ul style="list-style-type: none">• Do not perform maintenance on the conveyor until the start-up controls, including motor safety switches, are locked out and cannot be turned by any person other than the one performing the maintenance.• If more than, one member of a crew is working on the conveyor, EACH CREW MEMBER MUST HAVE A LOCK ON THE POWER LOCK OUT. The air pressure must be turned off to the work area. All pneumatic devices must be de-energized to prevent accidental cycling of the device.• Check the loosened parts have been retightened and all guards reinstalled.• Make sure personnel are clear of all conveyor equipment before restarting the system.

17.1 ITR TROUBLESHOOTING GUIDE

	<u>Problem</u>	<u>Possible Cause</u>	<u>Remedy</u>
1.	Power Roller does not turn	ITR roller not properly installed	Check that the Power Roller is properly inserted into the frame. Adjust as necessary
			Check the tube and end caps are not contacting the frame, side rails, or other parts. Power Roller should be allowed to move freely
		Too many slave rollers connected to drive roller	Inspect MDR zone to ensure proper number of idlers is adequate related to the Powered Roller. Refer to IOM Manual for additional information
		Power Cable extensively twisted	Inspect cable for kinks or cracks in wiring.
		Check that the Power Roller's shafts are properly mounted with the applicable bracket(s). Proper mounting is required for tube rotation.	For FE series motors one bracket securing the cable side shaft.
			For FS / FP / FH series motors two brackets securing both cable side and spring-loaded shafts
		When slave driving idler rollers check that, the number of idlers driven is adequate for the particular model of Power Roller being used.	Check air pressure on take up assembly. Make sure belt tension is proper.
		Check that the power cable is in good condition, with no twisting or severe kinks in the cable that would indicate broken wires. Also, check for any cuts in the power cable or wires near the connector end.	Locate and correct interference
Install belt properly			
2.	LED status	Red LED OFF, Green LED OFF, Orange LED OFF	Check that the power supply is on.
			Check that the card is correctly wired. Reference IOM manual.
			Measure the voltage, stable 24V DC is required.
		Red LED ON,	Check that the motor connector is properly plugged into the card then cycle the run / sensor signal.

	<u>Problem</u>	<u>Possible Cause</u>	<u>Remedy</u>
		Green LED ON, Orange LED ON if sensor is blocked	Thermal protection active – motor or card reached thermal limit, motor will not operate until one minute after the card, or motor has cooled down below thermal limit. Consider possible causes of why the Power Roller is reaching thermal limit; cycle times, ambient temperature, load changes, roller not turning freely, etc. Do not remove power to the card to reset the error, damage may occur
		Red LED OFF, Green LED ON, Orange LED ON if sensor is blocked	Check that the sensor is properly wired in the correct position and is the proper voltage. Reference IOM manual.
			If the run signal is coming from a device on a separate power supply check that the 0V lines are connected between the device’s power supply and the driver cards power supply.
			If using a run signal check the wiring to CN2 is in the correct position and wired correctly, see page 4 of the manual. Also, check that dip switch 2-8 is ON for run.
			If card is set to zone begin, dip switch 2-6 ON and the downstream zone is stopped and occupied, then the roller will not run. If card is set to zone end, dip switch 2-6 OFF, zone will accumulate product at the sensor. Reference IOM manual.
			Replace roller
3.	Flashing LED	Many options	Refer to IOM Manual for detailed information OR refer to appropriate ITOH Denki driver card manuals for additional options.
4.	Roller’s “dancing” or spinning uncontrollably	Too many zones on one ITR control circuit	Set direction blocking dip switch setting. Refer to IOM Manual for additional information.
		Power Supply not centered within the string of zones	Locate and Adjust Power Supply to correct current supply issue
		Supply of power not equally distributed	Set card to Basic Accumulation. Refer to IOM Manual for additional information.
		Mixture of driver cards	Within the ITR transportation product line, you can only use FP or FN cards within a string. Reference IOM Manual for additional information

	<u>Problem</u>	<u>Possible Cause</u>	<u>Remedy</u>
		Power Supply Issue	If power supply is not purchased from MHS, please consult manufactures operation directions.
		Multiple connected Power Supply units	OV line of all power supplies connected within a conveyor “unit” need to be connected. Reference IOM for additional detailed information
5.	Infeed zone not activating or running	Need input signal	Install MHS Conveyor start eye kit, or provide 24V run signal
		Loose connection between driver cards	Inspect, and adjust, connection cables as necessary
6.	Discharge zone not releasing	Down flow sending not providing “release” signal	Make sure photo eye and reflector are in alignment
		No “release” signal being provided	Use PLC connection, or Photo Eye & Reflector to provide zone with discharge open signal.
7.	One Zone not turning	Loose wire connection	Check all stranded wires to ensure they are inserted properly
		Loose connector cable	Check all quick connection within power harness to ensure they are properly connected.
8.	Driver Card continuously faulting	Poor supply of power	Inspect to see if power supply is transmitting correct voltage
		Power Supply unit not wired correctly to the 24V supply line	Inspect termination points to ensure proper wiring. Adjust accordingly. Reference IOM Manual for additional information.
		Bad bearing in wheel bracket or slave roller	Replace worn out component to relieve the extra stress on ITR roller.
9.	Rollers are turning slowly	Too many zones are connected to the Power Supply unit	Consult IOM Manual to ensure the proper configuration between Driver Cards and Power Supply unit.
		Wrong dip switch setting on driver card	Check dip switch setting of 1-6 is properly set to OFF for internal speed (rotary switch control) Refer to IOM Manual for additional settings.
10.	Driver cards faulting regularly in UBT	Programming issue. Transfer belt rollers running 24/7	ITR rollers driving the transfer bands only need to run when signal is provided to UBT to divert product.

	Problem	Possible Cause	Remedy
11.	Thermal Limit reached	Driver Card or Roller are over heating	Check the ambient temperature. Consult IOM Manual for acceptable temperature ranges
		Back plate of driver card not touching conveyor frame	Inspect mounting plate/conveyor surface to ensure complete surface connection for maximum heat dissipation.
		Excess friction or drag on motorized roller	Inspect area around roller to ensure nothing is rubber or lodged by the roller causing extra friction.
12	Electric Lift	Lift not working	Check switch to motors are properly set Check EZ24 Card settings

18 INTELLIROL REPLACEMENT PARTS

18.1 REPLACEMENT PARTS IDENTIFICATION

This section is used to identify parts that may require replacement during the life of the conveyor. Parts, which specifically pertain to MHS Conveyor conveyors, are included with illustrations. A "Recommended Spare Parts List" is published for all conveyor orders of \$20,000. This spare parts list is sent to the purchaser approximately (2) weeks after the order is received. It includes part numbers, description, pricing and recommended quantities to be kept on hand for maintenance. If you are unable to locate this document, another may be obtained by contacting the MHS Conveyor Lifetime Services at 231-798-4547.

18.2 SPARE PARTS PRIORITY LEVEL EXPLANATIONS

Level #1

Failure of a priority level #1 spare part ("A" level part) may cause major disruption of system performance.

Priority level 1 spare parts must be on-hand, and available to be replaced in the event of a component failure that could shut down a critical function of a conveyor system.

Priority level 1 spare parts include motors, gear reducers, gearmotor, motorized rollers, air solenoid valves, and related components. The majorities of these parts are purchased from MHS Conveyor vendors and carry their own warranties through these vendors. For more warranty information, see MHS Conveyor Equipment Warranty.

Level #2

Failure of a priority level #2 spare parts ("B" level part) usually is gradual and should not cause a major system disruption.

Priority level 2 spare parts are parts required for smooth system operation and preventative or regular mechanical maintenance.

Priority level 2 spare parts include roller chain, sprockets, belt pulleys, rollers, air cylinders, and other related parts whose failure should not stop a conveyor system suddenly. These parts tend to wear out gradually and are not known to fail suddenly.

Level #3

Priority level #3 parts ("C" level part) rarely fails and are easily obtainable.

Priority level 3 spare parts are parts that rarely fail or maybe optionally used by the customer.

18.3 REPLACEMENT PARTS - ITOH FE60 MDR

REPLACEMENT PARTS for ITOH FE-60 MOTORIZED ROLLER STANDARD ASSEMBLIES				
Item #	Description	(1) FIXING BRKT HEX AXLE-UP	Replacement Rollers	Description
1139544	ROLLER,ASY ITR 13.25BF 2G	FLAT	1139545	ROLLER,ITR 13.25BF 2G
1138727	ROLLER,ASY ITR 16BF 2G	FLAT	1138722	ROLLER,ITR 16BF 2G
1143630	ROLLER,ASY ITR 16BF 2G	POINT	1138722	ROLLER,ITR 16BF 2G
1140370	ROLLER,ASY ITR 16BF 2G CTD	FLAT	1140375	ROLLER,ITR 16BF 2G CTD
1138728	ROLLER,ASY ITR 22BF 2G	FLAT	1138723	ROLLER,ITR 22BF 2G
1142531	ROLLER,ASY ITR 22BF 2G	POINT	1138723	ROLLER,ITR 22BF 2G
1140371	ROLLER,ASY ITR 22BF 2G CTD	FLAT	1140376	ROLLER,ITR 22BF 2G CTD
1138729	ROLLER,ASY ITR 28BF 2G	FLAT	1138724	ROLLER,ITR 28BF 2G
1140372	ROLLER,ASY ITR 28BF 2G CTD	FLAT	1140377	ROLLER,ITR 28BF 2G CTD
1138730	ROLLER,ASY ITR 34BF 2G	FLAT	1138725	ROLLER,ITR 34BF 2G
1144662	ROLLER,ASY ITR 34BF 2G	POINT	1138725	ROLLER,ITR 34BF 2G
1140373	ROLLER,ASY ITR 34BF 2G CTD	FLAT	1140378	ROLLER,ITR 34BF 2G CTD

Reference DWG. 130S001

18.4 REPLACEMENT PARTS - ITOH DRIVERCARD STANDARDS

REPLACEMENT PARTS for ITOH DRIVERCARD STANDARD ASSEMBLIES	
Replacement Drivercard	Description
CB-02	DRIVERCARD, ITOH PM486 SERIES
1116036	DRIVERCARD, ITOH CB-016P7
1143591	DRIVERCARD, ITOH CB-016BP7
1153054	DRIVERCARD, ITOH CB-016N7
1153930	DRIVERCARD, ITOH CBM-105FP
1157157	DRIVERCARD, ITOH CBM-105FN
1101261	DRIVERCARD, ITOH HB-510P
1108863	DRIVERCARD, ITOH HB-510BP, BRAKE CONTROL
1166286	DRIVERCARD, ITOH IB-E03BP
1131443	DCM, 4-ZONE CONTROLLER

18.5 DRIVE AND SLAVE O-RINGS

REPLACEMENT PARTS - DRIVE AND SLAVE O-RINGS			
Item #	Description	Roller Centers	Application
E0005536	ORING,3/16DIA X 9.5" HT BLUE ITR 3"CTR	3"	STRAIGHT SLAVE
1142656	ORING,3/16 DIA X 7-3/4" HT BLUE ITR 2"CTR	2"	STRAIGHT SLAVE
1137420	ORING,3/16 DIA X 8.688 HT BLUE	2.50"	STRAIGHT SLAVE
1127703	ORING,3/16 DIA X 11" HT BLUE ITR 4"CTR	4"	STRAIGHT SLAVE
1102748	ORING,.210" DIA X 9.4" HT RED	3"	CURVE SLAVE
1102845	ORING,.210" DIA. X 11.5" HT RED	4.27"	CURVE DRIVE
1103665	ORING,3/16" DIA X 13" HT BLUE	N/A	SPUR (Clockwise Twist)
1133173	ORING,88A .218" DIA X 20-1/2" BLACK	N/A	UBT (Clockwise Twist)

18.6 RUN SIGNALS FOR CB-016 DRIVER CARD

RUN SIGNAL HARNESS FOR CB-016 DRIVER CARD		
Item No.	Description	Application
1144782	ELEC,ITR ACCUMULATION CURVE,1 MR, CB-016 PRESSURE SWITCH, LH/RH	USED TO POWER (1) ITR ROLLER FROM DOWNSTREAM NBC
1144783	ELEC,ITR ACCUMULATION CURVE,2 MR, CB-016 PRESSURE SWITCH, LH/RH	USED TO POWER (2) ITR ROLLER FROM DOWNSTREAM NBC
1146833	ELEC,ITR ACCUMULATION CURVE,3 MR, CB-016 PRESSURE SWITCH, LH/RH	USED TO POWER (3) ITR ROLLER FROM DOWNSTREAM NBC
1146832	ELEC,ITR ACCUMULATION CURVE,4 MR, CB-016 PRESSURE SWITCH, LH/RH	USED TO POWER (4) ITR ROLLER FROM DOWNSTREAM NBC

18.7 GENERAL CABLES, CONNECTORS, & KITS

GENERAL CABLES, CONNECTOR, & KITS		
Item No.	Description	Application
1167713	KIT,CTRLS-PE ZONE START-HB-FIELD MOUNT	USED TO START HB-510 DOWNSTREAM ZONE
1167714	ASY,CTRLS-PE ZONE START-HB-FACTORY MOUNT	USED TO START HB-510 DOWNSTREAM ZONE
1125371	KIT,ACC-CH TRANSITION-C6:CZ-BOTH SIDES	CH TRANSITION C6 TO CRUZ
1152538	ASY,CTRLS-PRSS SWTCH-CB TO NBC-FACTORY MOUNT TO ITR CURVE	USED FOR CURVES TO INTERFACE WITH NBC CHARGE END
1157661	ASY,CTRLS-PRSS SWTCH-HB TO NBC-FACTORY MOUNT TO NBC CHG BED	USED FOR CURVES TO INTERFACE WITH NBC DISCHARGE END
1207178	ELEC.CPART-ITR-POWER SUPPLY-SPLICE INSTALLATION	USED FOR SPLICE INSTALLATION
1120174	CONNECTOR, SIGNAL SPLICE	USED WITH RED RELEASE SIGNAL HARNESS

18.8 STANDARD ITR 24VDC POWER HARNESS

INTELLIROL 24VDC POWER HARNESS		
Item No.	Description	Application
1129502	HARNESS,ITR-POWER-10AWG-12.5'	24VDC POWER CABLE TO DRIVER CARDS
1102286	HARNESS,ITR-POWER-10AWG-10.5'	24VDC POWER CABLE TO DRIVER CARDS
1102287	HARNESS,ITR-POWER-10AWG-8'	24VDC POWER CABLE TO DRIVER CARDS
1102288	HARNESS,ITR-POWER-10AWG-5.5'	24VDC POWER CABLE TO DRIVER CARDS
1102289	HARNESS,ITR-POWER-10AWG-3'	24VDC POWER CABLE TO DRIVER CARDS
1143291	HARNESS,ITR-POWER-10AWG-10'-MALE-PIGTAIL	POWER CABLE W/ MALE CONNECT ONLY
1145665	HARNESS,ITR-POWER-10AWG-10'-FEMALE-PIGTAIL	POWER CABLE W/ FEMALE CONNECT ONLY
1161502	HARNESS,ITR-PWR INTRPT-10AWG-4"-COMMON CONDUCTOR	USED BETWEEN POWER SUPPLIES TO CONNECT COMMONS
1138166	HARNESS,ITR-POWER-10AWG-33'-(10 METER)	24VDC POWER CABLE TO DRIVER CARDS
3M567	CONNECTOR, POWER SPLICE 10 AWG	---
MALE/MALE POWER HARNESS		
1141545	HARNESS,ITR-POWER-10AWG-4"-MALE/MALE CONN	USE TO CHANGE POWER FLOW
1134347	HARNESS,POWER,10AWG,1' MALE CONN BOTH ENDS, GENDER BENDER	USE TO CHANGE POWER FLOW
1134348	HARNESS,POWER,10AWG,3'-MALE CONN BOTH ENDS-GENDER BENDER	USE TO CHANGE POWER FLOW
1134349	HARNESS,POWER,10AWG,5.5' MALE CONN BOTH ENDS, GENDER BENDER	USE TO CHANGE POWER FLOW
FEMALE/FEMALE POWER HARNESS		
1141549	HARNESS,ITR-POWER-10AWG-4"-FEMALE/FEMALE CONN	USE TO CHANGE POWER FLOW
1134344	HARNESS,POWER,10AWG,1' FEMALE CONN BOTH ENDS, GENDER BENDER	USE TO CHANGE POWER FLOW
1134345	HARNESS,POWER,10AWG,3' FEMALE CONN BOTH ENDS, GENDER BENDER	USE TO CHANGE POWER FLOW
1134346	HARNESS,POWER,10AWG,5.5' FEMALE CONN BOTH ENDS, GENDER BENDER	USE TO CHANGE POWER FLOW

18.9 CAT5 COMMUNICATION CABLES

DRIVER CARD - Cat5E COMMUNICATION CABLE		
Item No.	Description	Application
E0034025	CABLE,CTRLS-CAT5E-3'-GRAY	COMM. CABLE BETWEEN DRIVER CARDS
E0034026	CABLE,CTRLS-CAT5E-5'-GRAY	COMM. CABLE BETWEEN DRIVER CARDS
E0034027	CABLE,CTRLS-CAT5E-7'-GRAY	COMM. CABLE BETWEEN DRIVER CARDS
E0030796	CABLE,CTRLS-CAT5E-10'-GRAY	COMM. CABLE BETWEEN DRIVER CARDS
E0009905	CABLE,CTRLS-CAT5E-14'-GRAY	COMM. CABLE BETWEEN DRIVER CARDS
E0009904	CABLE,CTRLS-CAT5E-25'-GRAY	COMM. CABLE BETWEEN DRIVER CARDS

18.10 RUN SIGNAL HARNESS FOR CB-016 DRIVER CARD

RUN SIGNAL HARNESS FOR CB-016 DRIVER CARD		
Item No.	Description	Application
1144782	ELEC,ITR ACCUMULATION CURVE,1 MR, CB-016 PRESSURE SWITCH, LH/RH	USED TO POWER (1) ITR ROLLER FROM DOWNSTREAM NBC
1144783	ELEC,ITR ACCUMULATION CURVE,2 MR, CB-016 PRESSURE SWITCH, LH/RH	USED TO POWER (2) ITR ROLLER FROM DOWNSTREAM NBC
1146833	ELEC,ITR ACCUMULATION CURVE,3 MR, CB-016 PRESSURE SWITCH, LH/RH	USED TO POWER (3) ITR ROLLER FROM DOWNSTREAM NBC
1146832	ELEC,ITR ACCUMULATION CURVE,4 MR, CB-016 PRESSURE SWITCH, LH/RH	USED TO POWER (4) ITR ROLLER FROM DOWNSTREAM NBC

18.11 GENERAL CABLES, CONNECTORS & KITS

GENERAL CABLES, CONNECTOR, & KITS		
Item No.	Description	Application
1167713	KIT,CTRLS-PE ZONE START-HB-FIELD MOUNT	USED TO START HB-510 DOWNSTREAM ZONE
1167714	ASY,CTRLS-PE ZONE START-HB-FACTORY MOUNT	USED TO START HB-510 DOWNSTREAM ZONE
1125371	KIT,ACC-CH TRANSITION-C6:CZ-BOTH SIDES	CH TRANSITION C6 TO CRUZ
1152538	ASY,CTRLS-PRSS SWTCH-CB TO NBC-FACTORY MOUNT TO ITR CURVE	USED FOR CURVES TO INTERFACE WITH NBC CHARGE END
1157661	ASY,CTRLS-PRSS SWTCH-HB TO NBC-FACTORY MOUNT TO NBC CHG BED	USED FOR CURVES TO INTERFACE WITH NBC DISCHARGE END
1207178	ELEC,CPART-ITR-POWER SUPPLY-SPLICE INSTALLATION	USED FOR SPLICE INSTALLATION
1120174	CONNECTOR, SIGNAL SPLICE	USED WITH RED RELEASE SIGNAL HARNESS

18.12 CABLE, MOTOR EXTENSION USED WITH CBM-105, CB-016 OR HB-510

CABLE, MOTOR EXTENSION USED WITH CBM-105, CB-016 OR HB-510		
Item No.	Description	Application
1138704	CABLE,MOTOR EXTENSION,600MM ITOH M-F-EXT-9PIN-600 USED W/ CBM-105, CB-016 & HB-510	EXTEND DISTANCE BETWEEN DRIVER CARDS & ROLLER
1138705	CABLE,MOTOR EXTENSION,1200MM ITOH M-F-EXT-9PIN-1200 USED W/ CBM-105, CB-016 & HB-510	EXTEND DISTANCE BETWEEN DRIVER CARDS & ROLLER
1138706	CABLE,MOTOR EXTENSION,2700MM ITOH M-F-EXT-9PIN-2700 USED W/ CBM-105, CB-016 & HB-510	EXTEND DISTANCE BETWEEN DRIVER CARDS & ROLLER

18.13 CABLE, MOTOR EXTENSION USED WITH IB-E03

CABLE, MOTOR EXTENSION USED WITH IB-E03		
Item No.	Description	Application
1135339	CABLE,MOTOR EXTENSION,600MM ITOH M-F-EXT-10PIN-600, USE W/ IB-N03/IB-E/HBM-604/BRAKE	EXTEND DISTANCE BETWEEN DRIVER CARDS & ROLLER
1135340	CABLE,MOTOR EXTENSION,1200MM ITOH M-F-EXT-10PIN-1200, USE W/ IB-N03/IB-E/HBM-604/BRAKE	EXTEND DISTANCE BETWEEN DRIVER CARDS & ROLLER
1135341	CABLE,MOTOR EXTENSION,2700MM ITOH M-F-EXT-10PIN-2700, USE W/ IB-N03/IB-E/HBM-604/BRAKE	EXTEND DISTANCE BETWEEN DRIVER CARDS & ROLLER

18.14 COATED ROLLERS

COATED ROLLERS	
Item No.	Description
Non-Motorized Roller	
1134693	ROLLER,18ITR 1.9CTD PRBG-1/8"BLK URE SLV (16BF)
1132204	ROLLER,24ITR 1.9CTD PRBG-1/8"BLK URE SLV (22BF)
1131724	ROLLER,30ITR 1.9CTD PRBG-1/8"BLK URE SLV (28BF)
1140369	ROLLER,36ITR 1.9CTD PRBG-1/8"BLK URE SLV (34BF)
Motorized Roller	
1140375	ROLLER,ITR 16BF 2G CTD ITOH-PM486FE-60-391-D-24-P2-KF-1/8"BLK URE SLV
1140376	ROLLER,ITR 22BF 2G CTD ITOH-PM486FE-60-544-D-24-P2-KF-1/8"BLK URE SLV
1140377	ROLLER,ITR 28BF 2G CTD ITOH-PM486FE-60-696-D-24-P2-KF-1/8"BLK URE SLV
1140378	ROLLER,ITR 34BF 2G CTD ITOH-PM486FE-60-849-D-24-P2-KF-1/8"BLK URE SLV

18.15 ITR ADDITIONAL POWER HARNESS

INTELLIROL 24VDC POWER HARNESS - INCLINE & DECLINE		
Item No.	Description	Application
INCLINE BED, POWER HARNESS 24" & 30" ZONES, IBE		
1175349	HARNESS, POWER, 10AWG, W/DROPS-LH, (6) 24Z, IBE, 12.5'-BELTED 2MR PER ZONE	24VDC POWER CABLE TO DRIVER CARDS
1175350	HARNESS, POWER, 10AWG, W/DROPS-LH, (5) 24Z, IBE, 10.5'-BELTED 2MR PER ZONE	24VDC POWER CABLE TO DRIVER CARDS
1175351	HARNESS, POWER, 10AWG, W/DROPS-LH, (4) 24Z, IBE, 8.5'-BELTED 2MR PER ZONE	24VDC POWER CABLE TO DRIVER CARDS
1175352	HARNESS, POWER, 10AWG, W/DROPS-LH, (3) 24Z, IBE, 6.5'-BELTED 2MR PER ZONE	24VDC POWER CABLE TO DRIVER CARDS
1175353	HARNESS, POWER, 10AWG, W/DROPS-LH, (2) 24Z, IBE, 4.5'-BELTED 2MR PER ZONE	24VDC POWER CABLE TO DRIVER CARDS
1175354	HARNESS, POWER, 10AWG, W/DROPS-LH, (1) 24Z, IBE, 2.5'-BELTED 2MR PER ZONE	24VDC POWER CABLE TO DRIVER CARDS
1180795	HARNESS, POWER, 10AWG, W/DROPS-RH, (6) 24Z, IBE, 12.5'-BELTED 2MR PER ZONE	24VDC POWER CABLE TO DRIVER CARDS
1180796	HARNESS, POWER, 10AWG, W/DROPS-RH, (5) 24Z, IBE, 10.5'-BELTED 2MR PER ZONE	24VDC POWER CABLE TO DRIVER CARDS
1180797	HARNESS, POWER, 10AWG, W/DROPS-RH, (4) 24Z, IBE, 8.5'-BELTED 2MR PER ZONE	24VDC POWER CABLE TO DRIVER CARDS
1180798	HARNESS, POWER, 10AWG, W/DROPS-RH, (3) 24Z, IBE, 6.5'-BELTED 2MR PER ZONE	24VDC POWER CABLE TO DRIVER CARDS
1180799	HARNESS, POWER, 10AWG, W/DROPS-RH, (2) 24Z, IBE, 4.5'-BELTED 2MR PER ZONE	24VDC POWER CABLE TO DRIVER CARDS
1180800	HARNESS, POWER, 10AWG, W/DROPS-RH, (1) 24Z, IBE, 2.5'-BELTED 2MR PER ZONE	24VDC POWER CABLE TO DRIVER CARDS

HARNESS, HB-510 RUN SLAVE (DWG 130E090)		
Item No.	Description	Application
1155865	HARNESS, ITR, RUN SLAVE, HB-510 L=24"	24VDC POWER CABLE TO DRIVER CARDS

HARNESS, POWER, 10AWG WITH DROPS TO CB/HB 12", 24", AND 30" ZONES		
Item No.	Description	Application
1154912	HARNESS, POWER, 10AWG, W/DROPS (1)24"Z, 2.5'	24VDC POWER CABLE TO DRIVER CARDS
1149781	HARNESS, POWER, 10AWG, W/DROPS (2)24"Z, 4.5'	24VDC POWER CABLE TO DRIVER CARDS
1149780	HARNESS, POWER, 10AWG, W/DROPS (3)24"Z, 6.5'	24VDC POWER CABLE TO DRIVER CARDS
1149779	HARNESS, POWER, 10AWG, W/DROPS (4)24"Z, 8.5'	24VDC POWER CABLE TO DRIVER CARDS
1149778	HARNESS, POWER, 10AWG, W/DROPS (5)24"Z, 10.5'	24VDC POWER CABLE TO DRIVER CARDS
1149777	HARNESS, POWER, 10AWG, W/DROPS (6)24"Z, 12.5'	24VDC POWER CABLE TO DRIVER CARDS
1155918	HARNESS, POWER, 10AWG, W/DROPS HB-510 SLAVE, (1)24"Z, 2.5'	24VDC POWER CABLE TO DRIVER CARDS
1155917	HARNESS, POWER, 10AWG, W/DROPS HB-510 SLAVE, (2)24"Z, 4.5'	24VDC POWER CABLE TO DRIVER CARDS
1155916	HARNESS, POWER, 10AWG, W/DROPS HB-510 SLAVE, (3)24"Z, 6.5'	24VDC POWER CABLE TO DRIVER CARDS
1155915	HARNESS, POWER, 10AWG, W/DROPS HB-510 SLAVE, (4)24"Z, 8.5'	24VDC POWER CABLE TO DRIVER CARDS
1155914	HARNESS, POWER, 10AWG, W/DROPS HB-510 SLAVE, (5)24"Z, 10.5'	24VDC POWER CABLE TO DRIVER CARDS
1158808	HARNESS, POWER, 10AWG, W/DROPS (1)30"Z, 3'	24VDC POWER CABLE TO DRIVER CARDS
1158807	HARNESS, POWER, 10AWG, W/DROPS (2)30"Z, 5.5'	24VDC POWER CABLE TO DRIVER CARDS
1158806	HARNESS, POWER, 10AWG, W/DROPS (3)30"Z, 8'	24VDC POWER CABLE TO DRIVER CARDS
1158805	HARNESS, POWER, 10AWG, W/DROPS (4)30"Z, 10.5'	24VDC POWER CABLE TO DRIVER CARDS
1160080	HARNESS, POWER, 10AWG, W/DROPS (2)30"Z, 3'	24VDC POWER CABLE TO DRIVER CARDS
1160079	HARNESS, POWER, 10AWG, W/DROPS (4)30"Z, 5.5'	24VDC POWER CABLE TO DRIVER CARDS
1160078	HARNESS, POWER, 10AWG, W/DROPS (6)30"Z, 8'	24VDC POWER CABLE TO DRIVER CARDS
1160077	HARNESS, POWER, 10AWG, W/DROPS (8)30"Z, 10.5'	24VDC POWER CABLE TO DRIVER CARDS
1176465	HARNESS, POWER, 10AWG, W/DROPS-(1)24"Z, 2.5' DECLINE	24VDC POWER CABLE TO DRIVER CARDS
1176464	HARNESS, POWER, 10AWG, W/DROPS-(2)24"Z, 4.5' DECLINE	24VDC POWER CABLE TO DRIVER CARDS
1176463	HARNESS, POWER, 10AWG, W/DROPS-(3)24"Z, 6.5' DECLINE	24VDC POWER CABLE TO DRIVER CARDS
1176462	HARNESS, POWER, 10AWG, W/DROPS-(4)24"Z, 8.5' DECLINE	24VDC POWER CABLE TO DRIVER CARDS
1176461	HARNESS, POWER, 10AWG, W/DROPS-(5)24"Z, 10.5' DECLINE	24VDC POWER CABLE TO DRIVER CARDS
1176469	HARNESS, POWER, 10AWG, W/DROPS-(1)30"Z, 3' DECLINE	24VDC POWER CABLE TO DRIVER CARDS
1176468	HARNESS, POWER, 10AWG, W/DROPS-(2)30"Z, 5.5' DECLINE	24VDC POWER CABLE TO DRIVER CARDS
1176467	HARNESS, POWER, 10AWG, W/DROPS-(3)30"Z, 8' DECLINE	24VDC POWER CABLE TO DRIVER CARDS
1176466	HARNESS, POWER, 10AWG, W/DROPS-(4)30"Z, 10.5' DECLINE	24VDC POWER CABLE TO DRIVER CARDS

HARNESS POWER, LH 10AWG, W/DROPS TO IB-E01 BELTED DECLINE 24", & 30" ZONES		
Item No.	Description	Application
1165498	HARNESS, POWER, 10AWG, W/DROPS LH, (1) 24Z, IB-E01, 2.5' BELTED DECLINE	24VDC POWER CABLE TO DRIVER CARDS
1165497	HARNESS, POWER, 10AWG, W/DROPS LH, (2) 24Z, IB-E01, 4.5' BELTED DECLINE	24VDC POWER CABLE TO DRIVER CARDS
1165496	HARNESS, POWER, 10AWG, W/DROPS LH, (3) 24Z, IB-E01, 6.5' BELTED DECLINE	24VDC POWER CABLE TO DRIVER CARDS
1165495	HARNESS, POWER, 10AWG, W/DROPS LH, (4) 24Z, IB-E01, 8.5' BELTED DECLINE	24VDC POWER CABLE TO DRIVER CARDS
1165494	HARNESS, POWER, 10AWG, W/DROPS LH, (5) 24Z, IB-E01, 10.5' BELTED DECLINE	24VDC POWER CABLE TO DRIVER CARDS
1165493	HARNESS, POWER, 10AWG, W/DROPS LH, (6) 24Z, IB-E01, 12.5' BELTED DECLINE	24VDC POWER CABLE TO DRIVER CARDS
1165601	HARNESS, POWER, 10AWG, W/DROPS LH, (1) 30Z, IB-E01, 3' BELTED DECLINE	24VDC POWER CABLE TO DRIVER CARDS
1165600	HARNESS, POWER, 10AWG, W/DROPS LH, (2) 30Z, IB-E01, 5.5' BELTED DECLINE	24VDC POWER CABLE TO DRIVER CARDS
1165599	HARNESS, POWER, 10AWG, W/DROPS LH, (3) 30Z, IB-E01, 8' BELTED DECLINE	24VDC POWER CABLE TO DRIVER CARDS
1165598	HARNESS, POWER, 10AWG, W/DROPS LH, (4) 30Z, IB-E01, 10.5' BELTED DECLINE	24VDC POWER CABLE TO DRIVER CARDS

HARNESS POWER, RH 10AWG, W/DROPS TO IB-E01 BELTED DECLINE 24", & 30" ZONES		
Item No.	Description	Application
1165504	HARNESS, POWER, 10AWG, W/DROPS RH, (1) 24Z, IB-E01, 2.5' BELTED DECLINE	24VDC POWER CABLE TO DRIVER CARDS
1165503	HARNESS, POWER, 10AWG, W/DROPS RH, (2) 24Z, IB-E01, 4.5' BELTED DECLINE	24VDC POWER CABLE TO DRIVER CARDS
1165502	HARNESS, POWER, 10AWG, W/DROPS RH, (3) 24Z, IB-E01, 6.5' BELTED DECLINE	24VDC POWER CABLE TO DRIVER CARDS
1165501	HARNESS, POWER, 10AWG, W/DROPS RH, (4) 24Z, IB-E01, 8.5' BELTED DECLINE	24VDC POWER CABLE TO DRIVER CARDS
1165500	HARNESS, POWER, 10AWG, W/DROPS RH, (5) 24Z, IB-E01, 10.5' BELTED DECLINE	24VDC POWER CABLE TO DRIVER CARDS
1165499	HARNESS, POWER, 10AWG, W/DROPS RH, (6) 24Z, IB-E01, 12.5' BELTED DECLINE	24VDC POWER CABLE TO DRIVER CARDS
1165605	HARNESS, POWER, 10AWG, W/DROPS RH, (1) 30Z, IB-E01, 3' BELTED DECLINE	24VDC POWER CABLE TO DRIVER CARDS
1165604	HARNESS, POWER, 10AWG, W/DROPS RH, (2) 30Z, IB-E01, 5.5' BELTED DECLINE	24VDC POWER CABLE TO DRIVER CARDS
1165603	HARNESS, POWER, 10AWG, W/DROPS RH, (3) 30Z, IB-E01, 8' BELTED DECLINE	24VDC POWER CABLE TO DRIVER CARDS
1165602	HARNESS, POWER, 10AWG, W/DROPS RH, (4) 30Z, IB-E01, 10.5' BELTED DECLINE	24VDC POWER CABLE TO DRIVER CARDS

HARNESS POWER, LH or RH 10AWG, W/DROPS TO IB-E01 BELTED HORIZONTAL		
Item No.	Description	Application
1166178	HARNESS, POWER, 10AWG, W/DROPS LH, (4) 30Z, IB-E03, 10.5' BELTED HORIZONTAL	BELTED HORIZONTAL
1166181	HARNESS, POWER, 10AWG, W/DROPS LH, (1) 30Z, IB-E03, 3' BELTED HORIZONTAL	BELTED HORIZONTAL
1166180	HARNESS, POWER, 10AWG, W/DROPS LH, (2) 30Z, IB-E03, 5.5' BELTED HORIZONTAL	BELTED HORIZONTAL
1166179	HARNESS, POWER, 10AWG, W/DROPS LH, (3) 30Z, IB-E03, 8' BELTED HORIZONTAL	BELTED HORIZONTAL
1166185	HARNESS, POWER, 10AWG, W/DROPS RH, (1) 30Z, IB-E03, 3' BELTED HORIZONTAL	BELTED HORIZONTAL
1166184	HARNESS, POWER, 10AWG, W/DROPS RH, (2) 30Z, IB-E03, 5.5' BELTED HORIZONTAL	BELTED HORIZONTAL
1166183	HARNESS, POWER, 10AWG, W/DROPS RH, (3) 30Z, IB-E03, 8' BELTED HORIZONTAL	BELTED HORIZONTAL
1166182	HARNESS, POWER, 10AWG, W/DROPS RH, (4) 30Z, IB-E03, 10.5' BELTED HORIZONTAL	BELTED HORIZONTAL

Contact MHS Conveyor Lifetime Services for additional power harness.

18.16 HARNESS, GENDER CHANGING

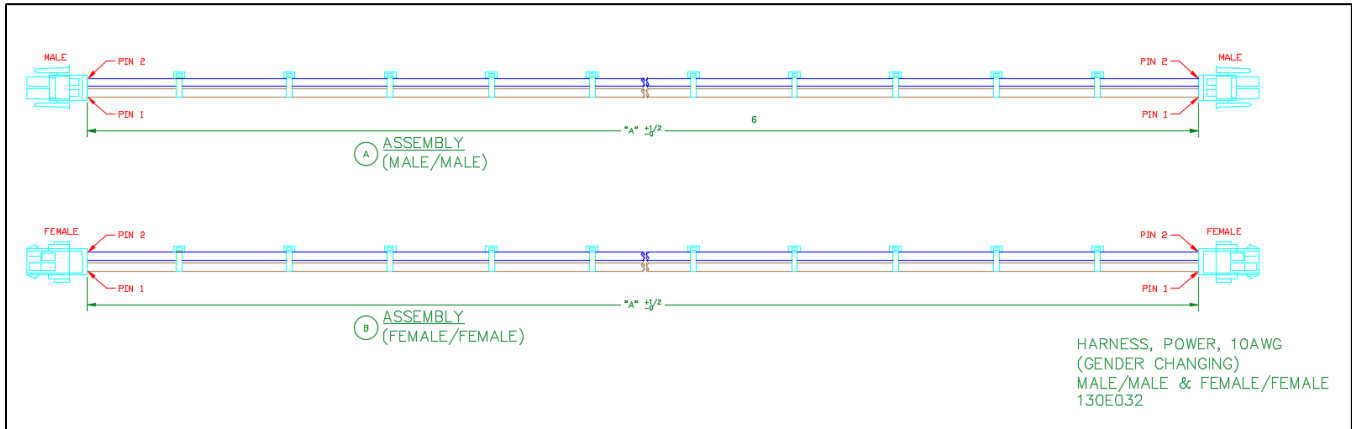

18.16.1 Replacement Parts – Harness, Gender Changing

MALE/MALE POWER HARNESS	
Item No.	Description
1141545	HARNESS, POWER, 10AWG, 0'4"
1134347	HARNESS, POWER, 10AWG, 1'-0"
1134348	HARNESS, POWER, 10AWG, 3'-0"
1134349	HARNESS, POWER, 10AWG, 5'-6"
FEMALE/FEMALE POWER HARNESS	
1141549	HARNESS, POWER, 10AWG, 0'4"
1134344	HARNESS, POWER, 10AWG, 1'-0"
1134345	HARNESS, POWER, 10AWG, 3'-0"
1134346	HARNESS, POWER, 10AWG, 5'-6"
Ref Dwg, 130E032	

18.17 PHOTOEYE AND PRESSURE SWITCH

General Photoeye Cables & Kit				
Balloon	Item #	Description	Mounted	DWG #
1 - 8	1167713	KIT,P/E ZONE START HB-510	FIELD MOUNTED	130I011

General Photoeye Cables & Kit				
Balloon	Item #	Description	Mounted	DWG #
1 - 6	1165676	KIT,CTRLS-PE ZONE START- IBE	FIELD MOUNTED	130I010

Pressure Switch Kit,CB to NBC				
Balloon	Item #	Description	Mounted	DWG #
ALL	1152711	KIT,ITR-PRSS SWTCH- CB TO NBC	FIELD MOUNTED	130E068

Accumulation Discharge Logic Control LH / RH Pressure Switch Kit,HB to NBC				
Balloon	Item #	Description	Mounted	DWG #
ALL	1157702	KIT,ITR-PRSS SWTCH- HB TO NBC	FIELD MOUNTED	130E099

18.18 SHROUDS

CRUZchannel SHROUD 5' Long (ONE SIDE)		
Part Number	Description	Approx. Weight (Lbs.)
E0005540	SHROUD,ACC-ITR-5'-W/WARNING LABEL-CZ CHANNEL	2
1207829	SHROUD,ACC-CZ-5'-W/MHS LABEL	2
1118558	SHROUD,ACC-CZ-5'-L/LABEL	2

C6 Channel SHROUD 5' Long (ONE SIDE)		
Part Number	Description	Approx. Weight (Lbs.)
1158487	KIT,ACC-SHRD-C6-5'-W/WARNING LABEL	2
1158488	KIT,ACC-SHRD-C6-5'-L/LABEL	2
1207889	KIT,ACC-SHRD-C6-5'-W/MHS LABEL	2

ITR GATE SHROUD (BOTH SIDES)		
Part Number	Description	Approx. Weight (Lbs.)
1218139	SHROUD,ACC-ITR-5'-W/WARNING LABEL-CZ CHANNEL	2

ITR GATE SHROUD (FOR EACH INDIVIDUAL SIDE)		
Part Number	Description	Approx. Weight (Lbs.)
1225270	KIT,ACC-SHRD-ITR GATE-39" LH-W/WARNING LABEL	2
1225271	KIT,ACC-SHRD-ITR GATE-39" RH-W/WARNING LABEL	2

18.19 ACCUMULATION STRAIGHT BED ZONE

18.19.1 Straight Bed 24" Zone

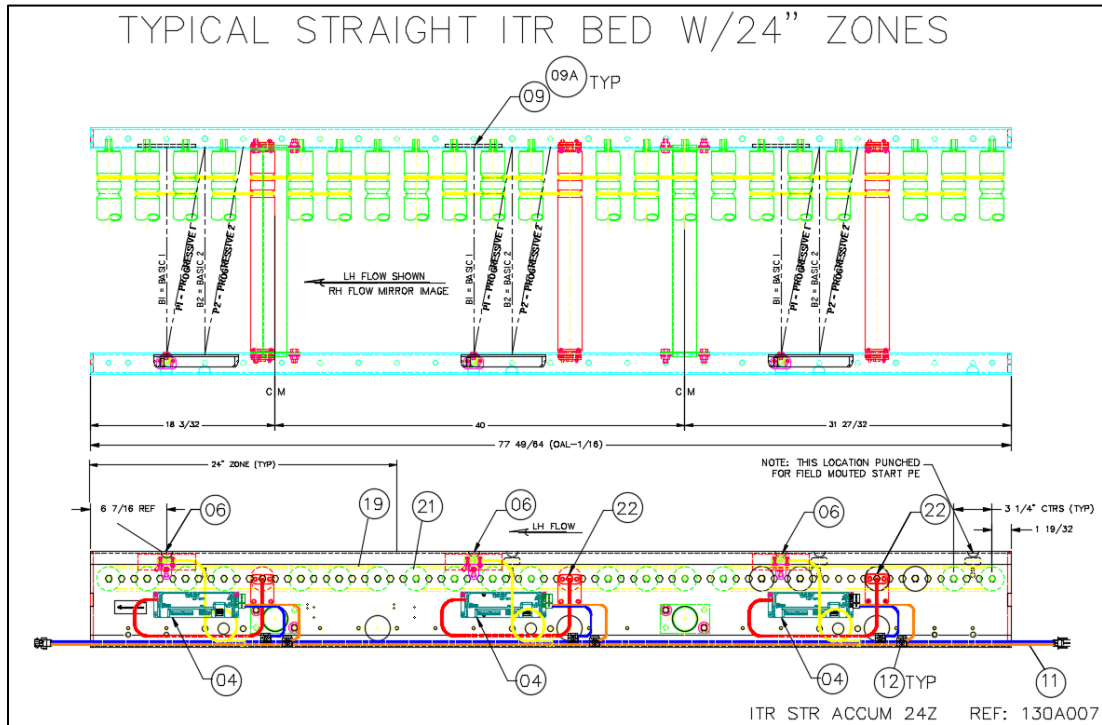

18.19.2 Straight Bed 30" Zone

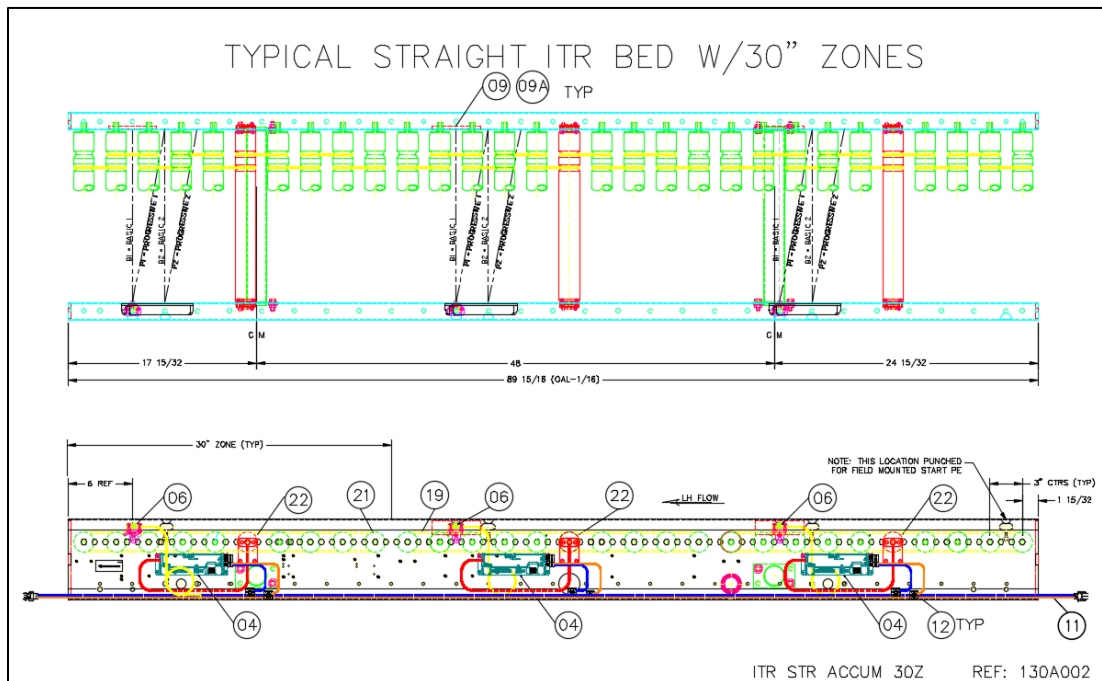

18.19.3 Replacement Parts – ITR Accumulation Straight Bed 24” & 30” Zone

REPLACEMENT PARTS - ITR ACCUMULATION STRAIGHT BED (24 & 30 Zone)					
BED,ITR-__BF-(HB OR IBE)-CZ-(3RC OR 2RC)- (24Z OR 30Z)- (LH OR RH)-FE60		Width & Item #			
Balloon	Description	16 BF	22 BF	28 BF	34 BF
04	DRIVERCARD,ITOH HB-510P	1101261	1101261	1101261	1101261
04	DRIVERCARD,ITOH IB-E03BP	1166286	1166286	1166286	1166286
---	HARNESS,POWER BROWN & BLUE (NOT BF SPECIFIC)	3'-0" L 1102289	5'-5" L 1102288	8'-0" L 1102287	10'-6" L 1102286
---	CABLE,CTRLS-CAT5E-_-GRAY	DRIVER CARD CAT5E COMMUNICATION CABLES			
---	CABLE,MOTOR EXTENSION, 600,1200,OR 2700 MM LONG	REFERENCE CABLE, MOTOR EXTENSION USED WITH STATED DRIVER CARD			
06	PE,REFLEX TYPE ZL, PNP, DARK OPERATE (USED WITH HB-510)	1137687	1137687	1137687	1137687
06	PE,REFLEX TYPE ZL, PNP, LIGHT OPERATE (USED WITH IB-E03)	1163456	1163456	1163456	1163456
9A	PE,REFLECTOR 4-3/8" X 1-1/8"	400004	400004	400004	400004
18	ORING,3/16" DIA X 15.312" HT BLUE FOR ITR 6.5" CTRS (20% STRETCH)	1167247	1167247	1167247	1167247
19	ORING,3/16DIA X 7-3/4" HT BLUE ITR 2"CTR	1142656	1142656	1142656	1142656
19	ORING,3/16 DIA X 9.5" HT BLUE ITR 3"CTR	E0005536	E0005536	E0005536	E0005536
21	ROLLER, _ ITR 1.9" DIA PLTD (_ BF)	E0002412	E0002413	E0002414	E0006220
22	ROLLER,ITR _ BF 2G ITOH PM486FE-60 (USED W/HB-510)	1138722	1138723	1138724	1138725
22	ROLLER,ITR _ BF 2G ITOH PM486FE-60 (USED W/ IBE)	1163471	1163472	1163473	1163474

Reference Dwg 130A002 & 130A007

18.20 ITR TRANSPORTATION STRAIGHT BED

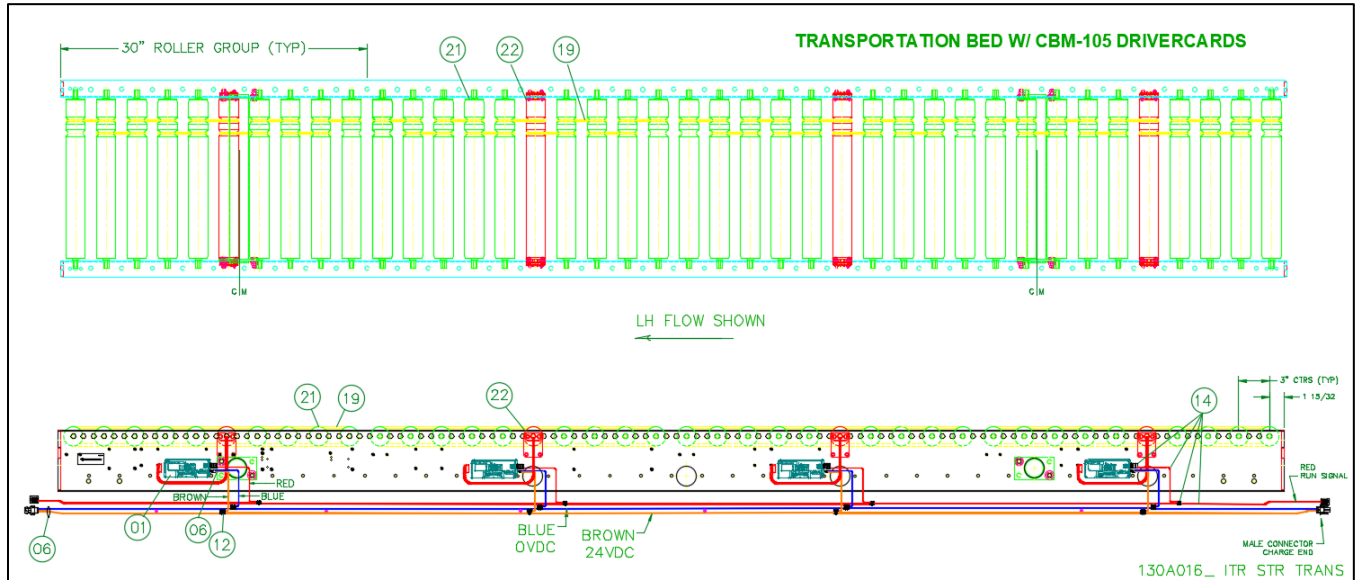

18.20.1 Replacement Parts – ITR Transportation Straight Bed

REPLACEMENT PARTS - ITR TRANSPORTATION STRAIGHT BEDS (2RC & 3RC)					
BED, ITR-__BF-CB-C6-(2RC OR 3RC)-30RG-LH/RH-FE60		Width & Item #			
BALLOON	Description	16 BF	22 BF	28 BF	34 BF
1	DRIVERCARD, ITOH CBM-105FP	1153930	1153930	1153930	1153930
6	HARNESS, POWER BROWN & BLUE (NOT BF SPECIFIC)	3'-0" L 1102289	5'-6" L 1102288	8'-0" L 1102287	10'-6" L 1102286
14	CABLE, MOTOR EXTENSION, 600, 1200, OR 2700 MM LONG	REFERENCE CABLE, MOTOR EXTENSION USED WITH STATED DRIVER CARD			
12	CONNECTOR, IDC SCOTCHLOK 567 - BROWN	3M567	3M567	3M567	3M567
19	ORING, 3/16 DIA X 9.5" HT BLUE ITR 3"CTR	E0005536	E0005536	E0005536	E0005536
19	ORING, 3/16 DIA X 7-3/4" HT BLUE ITR 2"CTR	1142656	1142656	1142656	1142656
21	ROLLER, __ ITR 1.9" DIA PLTD PRBG (__ BF)	E0002412	E0002413	E0002414	E0006220
22	ROLLER, ITR __ BF 2G ITOH PM486FE-60	1138722	1138723	1138724	1138725

Reference Dwg. 130A016

18.21 ITR SKEW BED

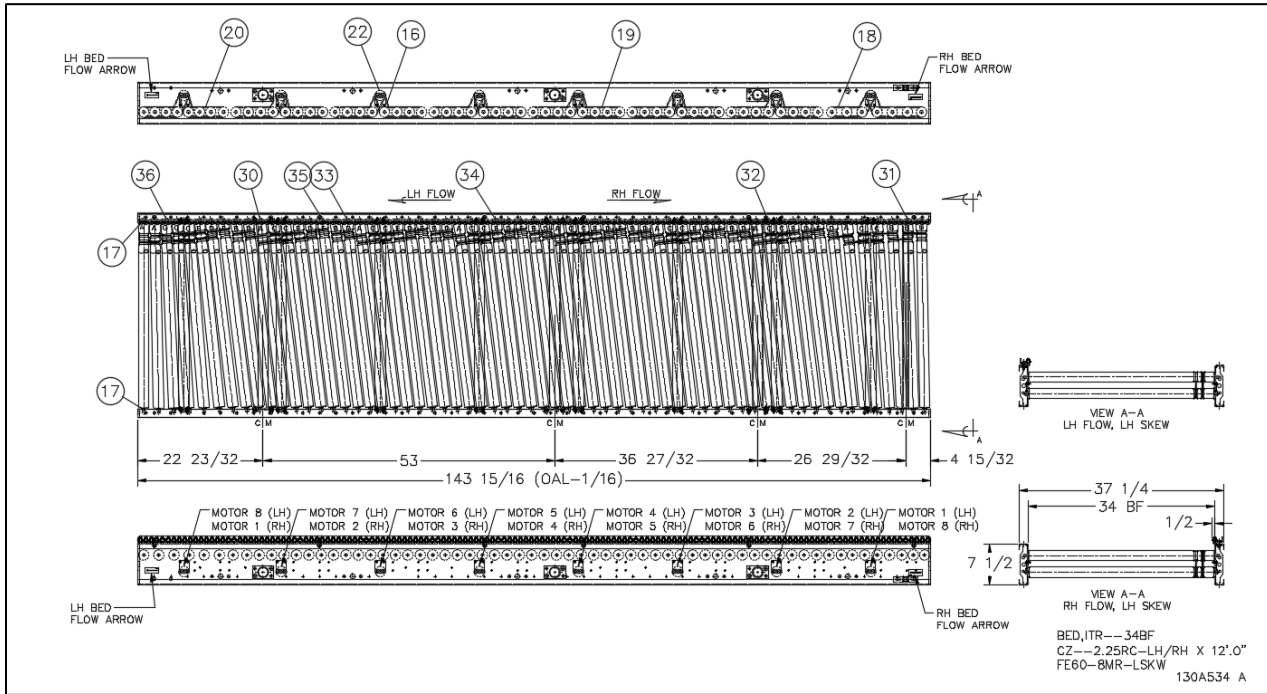

18.21.1 Replacement Parts - ITR Skew Bed

REPLACEMENT PARTS - ITR SKEW BEDS, 2.25RC,FE60					
Balloon	Description	Width & Item #			
		16 BF	22 BF	28 BF	34 BF
16	ORING, .210 DIA X 10.0" HT RED	1130498	11304982	11304983	11304984
17	ORING, 1/2"ID (3/32 WALL)	90530050	90530050	90530050	90530050
18	ORING, .210 DIA X 9-1/4" HT RED	1142106	1142106	1142106	1142106
19	ORING, .210 DIA X 8.5" HT RED	1116838	1116838	1116838	1116838
20	ORING, .210 DIA X 8.25" HT RED	1194480	1194480	1194480	1194480
30	ROLLER, 16BF ITR SKEW, STYLE A	1194116	1194123	1194130	1194137
31	ROLLER, 16BF ITR SKEW, STYLE B	1194117	1194124	1194131	1194138
32	ROLLER, 16BF ITR SKEW, STYLE C	1194118	1194125	1194132	1194139
33	ROLLER, 16BF ITR SKEW, STYLE D	1194119	1194126	1194133	1194140
34	ROLLER, 16BF ITR SKEW, STYLE E	1194120	1194127	1194134	1194141
35	ROLLER, 16BF ITR SKEW, STYLE F	1194121	1194128	1194135	1194142
36	ROLLER, 16BF ITR SKEW, STYLE G	1194122	1194129	1194136	1194143
---	WHEEL, SKATE 7/8DIA X 1/4BORE	E0031762	E0031762	E0031762	E0031762
22	ROLLER, ITR BF 2G ITOH PM486FE-60	1138722	1138723	1138724	1138725
---	DRIVERCARD, ASY ITOH CBM-105FP	1153930	1153930	1153930	1153930
---	CABLE, MOTOR EXTENSION, 600MM, ITOH M-F-EXT-9PIN-600	1138704	1138704	1138704	1138704
ROLLER GROUP					
15RG	HARNESS, POWER, 10AWG, W/DROPS, (4), 5.5', ITR SKEW	1193743	1193743	1193743	1193743
15RG	HARNESS, RUN SIGNAL, W/DROPS, (4), 5.5', ITR SKEW	1193747	1193747	1193747	1193747
17RG	HARNESS, POWER, 10AWG, W/DROPS, (7), 10.5', ITR SKEW	1193742	1193742	1193742	1193742
17RG	HARNESS, RUN SIGNAL, W/DROPS, (7), 10.5', ITR SKEW	1193746	1193746	1193746	1193746
18RG	HARNESS, POWER, 10AWG, W/DROPS, (8), 12.5', ITR SKEW	1193741	1193741	1193741	1193741
18RG	HARNESS, RUN SIGNAL, W/DROPS, (8), 12.5', ITR SKEW	1193745	1193745	1193745	1193745

Reference Dwg: 130A534

18.22 ITR ACCUMULATION CURVES

18.22.1 ITR Cruz Channel Accumulating 45 Degree Curve

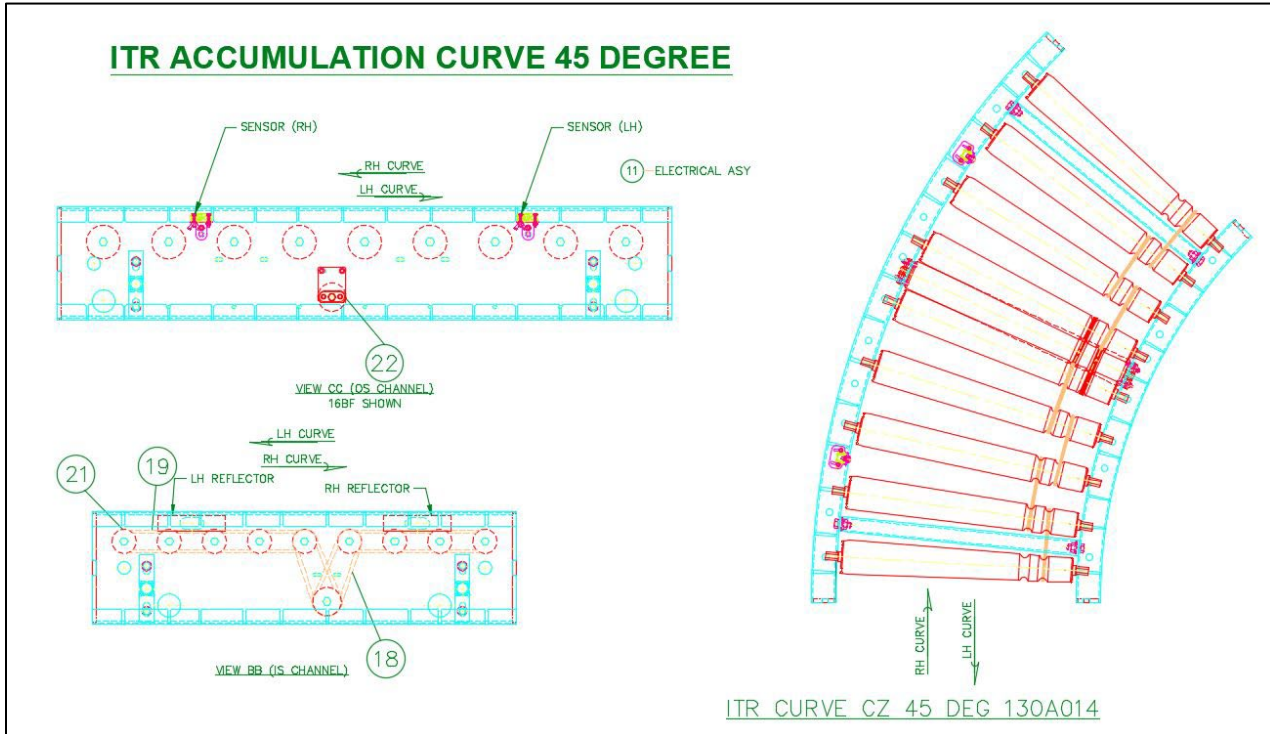

18.22.2 ITR Cruz Channel Accumulating 60 Degree Curve

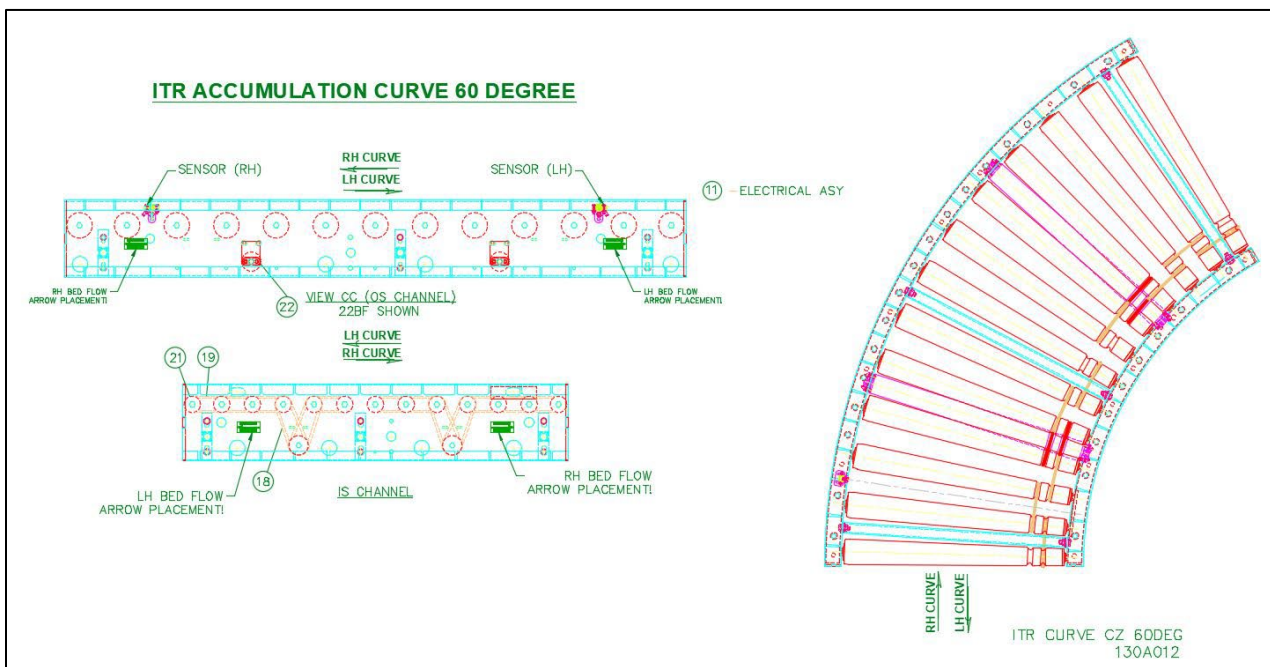

18.22.3 ITR Cruz Channel Accumulating 90 Degree Curve

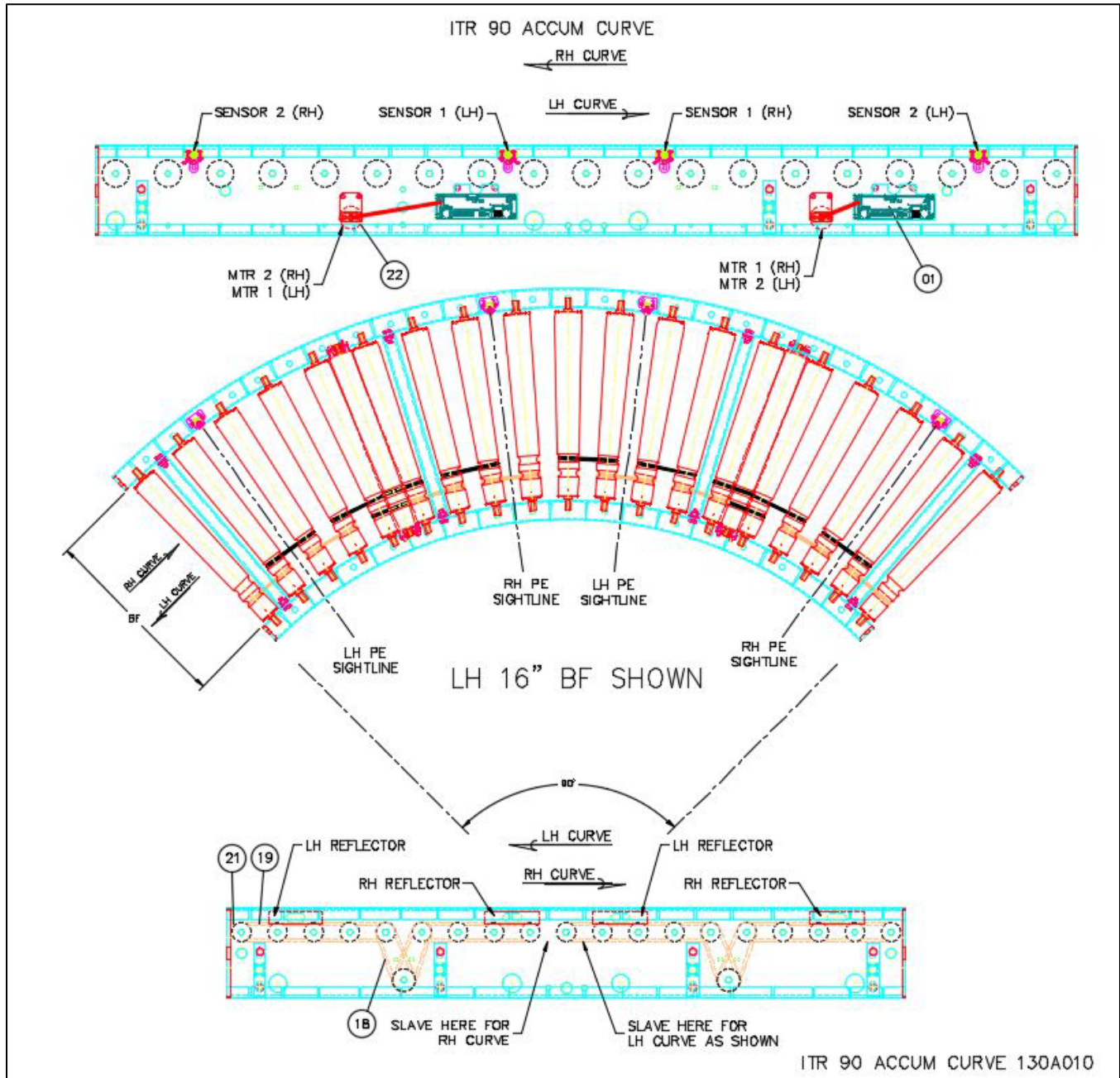

18.22.3.1 Replacement Parts – ITR Accumulation Curve, HB, CB, STD & HDR

REPLACEMENT PARTS - ITR ACCUMULATION CURVES, STANDARD HB, 45, 60, & 90 DEGREES					
CURVE, ITR-__BF-(HB)-CZ-(STD)-_Z,__D-LH/RH-FE60-_MR		Width & Item #			
Balloon	Description	16 BF	22 BF	28 BF	34 BF
01	DRIVERCARD, ITOH HB-510P	1101261	1101261	1101261	1101261
01	DRIVERCARD, ITOH CBM-105FP (USED W/60 DEG)	1153930	1153930	1153930	1153930
---	PE, REFLEX TYPE ZL	1137687	1137687	1137687	1137687
---	PE, REFLECTOR 4-3/8" X 1-1/8"	400004	400004	400004	400004
---	HARNESS, POWER BROWN & BLUE (NOT BF SPECIFIC)	3'-0" L 1102289	5'-6" L 1102288	8'-0" L 1102287	10'-6" L 1102286
---	CABLE, MOTOR EXTENSION, 600, 1200, OR 2700 MM LONG	REFERENCE CABLE, MOTOR EXTENSION USED WITH STATED DRIVER CARD			
---	CABLE, CTRLS-CAT5E-_-GRAY	REFERENCE Cat5E COMMUNICATION CABLE			
12	CONNECTOR, IDC SCOTCHLOK 567 - BROWN	3M567	3M567	3M567	3M567
18	ORING, .210" DIA. X 11.5" HT RED MARKED W/BLACK STRIPE	1102845	1102845	1102845	1102845
19	ORING, .210" DIA X 9.4" HT RED	1102748	1102748	1102748	1102748
21	ROLLER, W TT ITR 2 GRV PRBG	E0009900	E0009901	E0009902	E0009903
22	ROLLER, ITR __BF 2G ITOH PM486FE-60	1138722	1138723	1138724	1138725

Reference Dwg: Accumulation Curve 130A014 & 130A012 & 130A010

REPLACEMENT PARTS - ITR ACCUMULATION CURVES, HIGH DENSITY ROLLER, HB, 30, 45, 60, & 90 DEGREES					
CURVE, ITR-__BF-(HB)-CZ-(HDR)-_Z,__D-LH/RH-FE60-_MR		Width & Item #			
Balloon	Description	16 BF	22 BF	28 BF	34 BF
01	DRIVERCARD, ITOH HB-510P	1101261	1101261	1101261	1101261
01	DRIVERCARD, ITOH CBM-105FP (USED W/45, 60, & 90 DEG)	1153930	1153930	1153930	1153930
---	PE, REFLEX TYPE ZL	1137687	1137687	1137687	1137687
---	PE, REFLECTOR 4-3/8" X 1-1/8"	400004	400004	400004	400004
---	HARNESS, POWER BROWN & BLUE (NOT BF SPECIFIC)	3'-0" L 1102289	5'-6" L 1102288	8'-0" L 1102287	10'-6" L 1102286
---	CABLE, MOTOR EXTENSION, 600, 1200, OR 2700 MM LONG	REFERENCE CABLE, MOTOR EXTENSION USED WITH STATED DRIVER CARD			
---	CABLE, CTRLS-CAT5E-_-GRAY	REFERENCE Cat5E COMMUNICATION CABLE			
12	CONNECTOR, IDC SCOTCHLOK 567 - BROWN	3M567	3M567	3M567	3M567
18	ORING, .210 DIA X 11.13 HT RED	1102711	1102711	1102711	1102711
19	ORING, .210 DIA X 7.5 HT RED	1185142	1185142	1185142	1185142
21	ROLLER, W TT ITR 2 GRV PRBG	E0009900	E0009901	E0009902	E0009903
22	ROLLER, ITR __BF 2G ITOH PM486FE-60	1138722	1138723	1138724	1138725

Reference Dwg: Accumulation Curve 130A014 & 130A012 & 130A010

18.22.3.2 Replacement Parts – ITR Accumulation Curve, IB-E03, STD & HDR

REPLACEMENT PARTS - ITR ACCUMULATION CURVES, STANDARD, IBE, 45, 60, & 90 DEGREES					
CURVE, ITR-__BF-(IBE)-CZ-(STD)-_Z,_D-LH/RH-FE60-_MR		Width & Item #			
Balloon	Description	16 BF	22 BF	28 BF	34 BF
01	DRIVERCARD, ITOH IB-E03BP	1166286	1166286	1166286	1166286
01	PE, REFLEX TYPE ZL	1163456	1163456	1163456	1163456
----	HARNESS, POWER BROWN & BLUE (NOT BF SPECIFIC)	3'-0" L 1102289	5'-6" L 1102288	8'-0" L 1102287	10'-6" L 1102286
----	CABLE, MOTOR EXTENSION, 600, 1200, OR 2700 MM LONG	REFERENCE CABLE, MOTOR EXTENSION USED WITH STATED DRIVER CARD			
----	CABLE, CTRLS-CAT5E-_-GRAY	REFERENCE Cat5E COMMUNICATION CABLE			
---	PE, REFLECTOR 4-3/8" X 1-1/8"	400004	400004	400004	400004
---	CONN, WAGO 231-302/026-000	1162204	1162204	1162204	1162204
12	CONNECTOR, IDC SCOTCHLOK 567	3M567	3M567	3M567	3M567
18	ORING, .210" DIA. X 11.5" HT RED MARKED W/BLACK STRIPE	1102845	1102845	1102845	1102845
19	ORING, .210" DIA X 9.4" HT RED	1102748	1102748	1102748	1102748
21	ROLLER, 36W TT ITR 2GRV PRBG __BF	E0009900	E0009901	E0009902	E0009903
22	ROLLER, ITR __BF 2G ITOH PM486FE-60	1163471	1163472	1163473	1163474
Reference Dwg: Accumulation Curve 130A014 & 130A012 & 130A010					

REPLACEMENT PARTS - ITR ACCUMULATION CURVES, HIGH DENSITY ROLLER, IBE, 30, 45, 60, & 90 DEGREES					
CURVE, ITR-__BF-(IBE)-CZ-(HDR)-_Z,_D-LH/RH-FE60-_MR		Width & Item #			
Balloon	Description	16 BF	22 BF	28 BF	34 BF
01	DRIVERCARD, ITOH IB-E03BP	1166286	1166286	1166286	1166286
01	PE, REFLEX TYPE ZL	1163456	1163456	1163456	1163456
10	PE, REFLECTOR 4-3/8" X 1-1/8"	400004	400004	400004	400004
----	HARNESS, POWER BROWN & BLUE (NOT BF SPECIFIC)	3'-0" L 1102289	5'-6" L 1102288	8'-0" L 1102287	10'-6" L 1102286
----	CABLE, MOTOR EXTENSION, 600, 1200, OR 2700 MM LONG	REFERENCE CABLE, MOTOR EXTENSION USED WITH STATED DRIVER CARD			
----	CABLE, CTRLS-CAT5E-_-GRAY	REFERENCE Cat5E COMMUNICATION CABLE			
---	CONN, WAGO 231-302/026-000	1162204	1162204	1162204	1162204
12	CONNECTOR, IDC SCOTCHLOK 567	3M567	3M567	3M567	3M567
18	ORING, .210 DIA X 11.13 HT RED	1102711	1102711	1102711	1102711
19	ORING, .210 DIA X 7.5 HT RED	1185142	1185142	1185142	1185142
21	ROLLER, 36W TT ITR 2GRV PRBG	E0009900	E0009901	E0009902	E0009903
22	ROLLER, ITR __BF 2G ITOH PM486FE-60	1163471	1163472	1163473	1163474
Reference Dwg: Accumulation Curve 130A014 & 130A012 & 130A010					

18.23 ITR TRANSPORTATION CURVES

18.23.1 ITR Transportation Curve 30 Degree

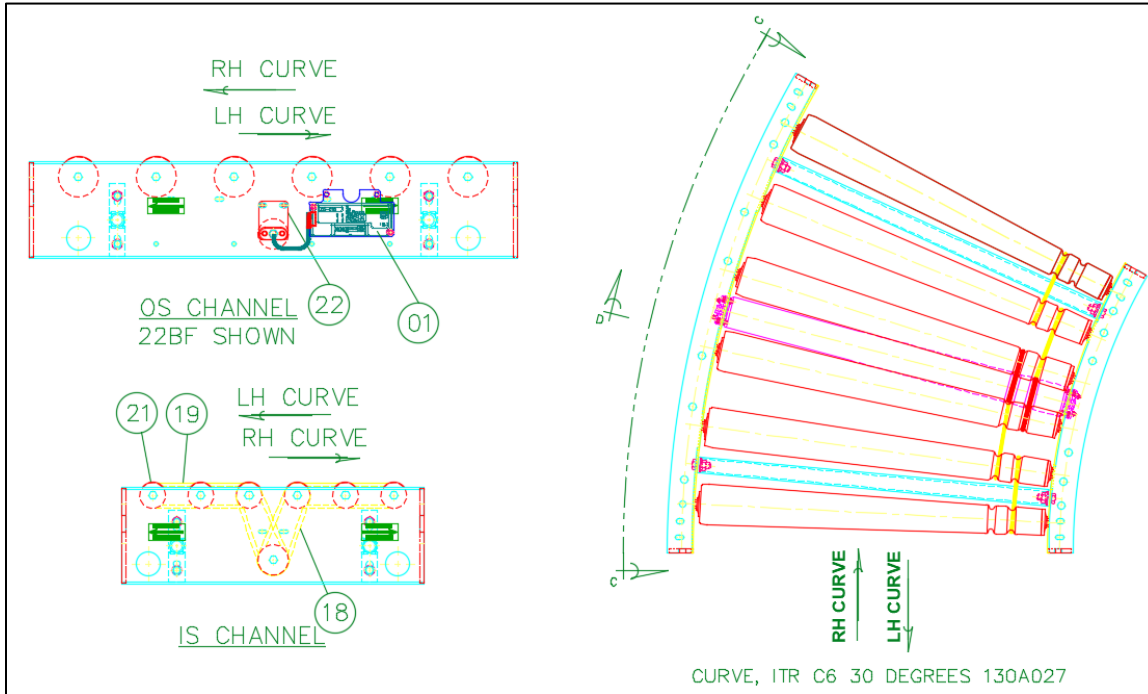

18.23.2 ITR Transportation Curve 45 Degree

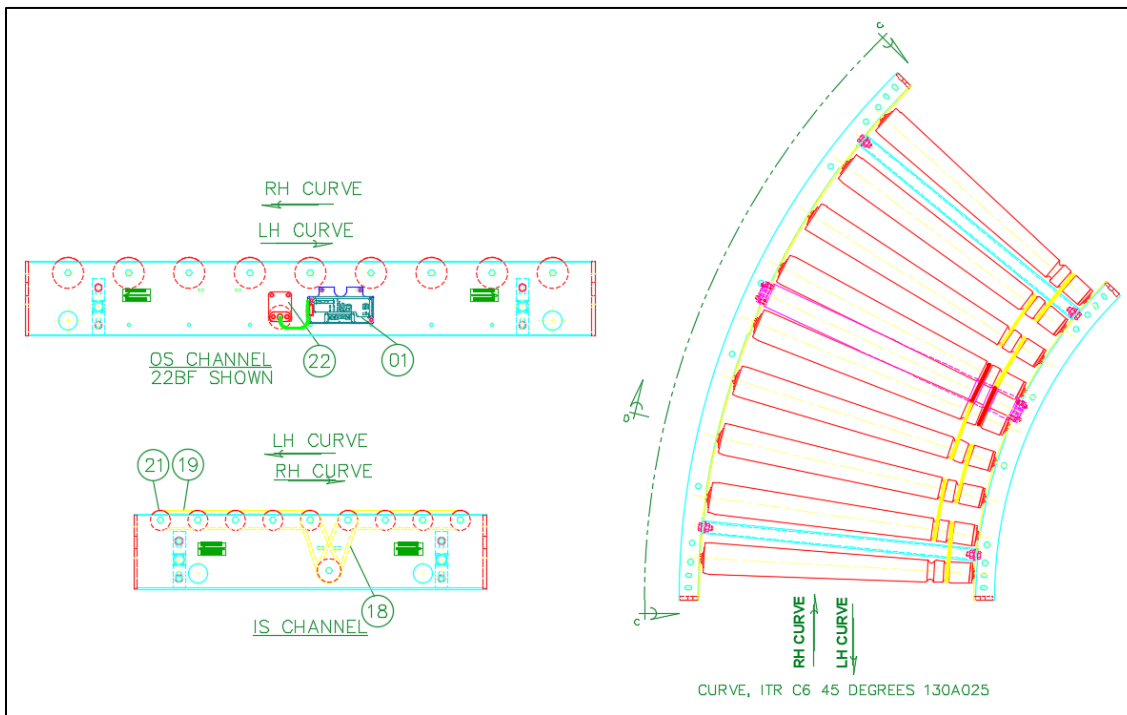

18.23.3 ITR Transportation Curve 60 Degree

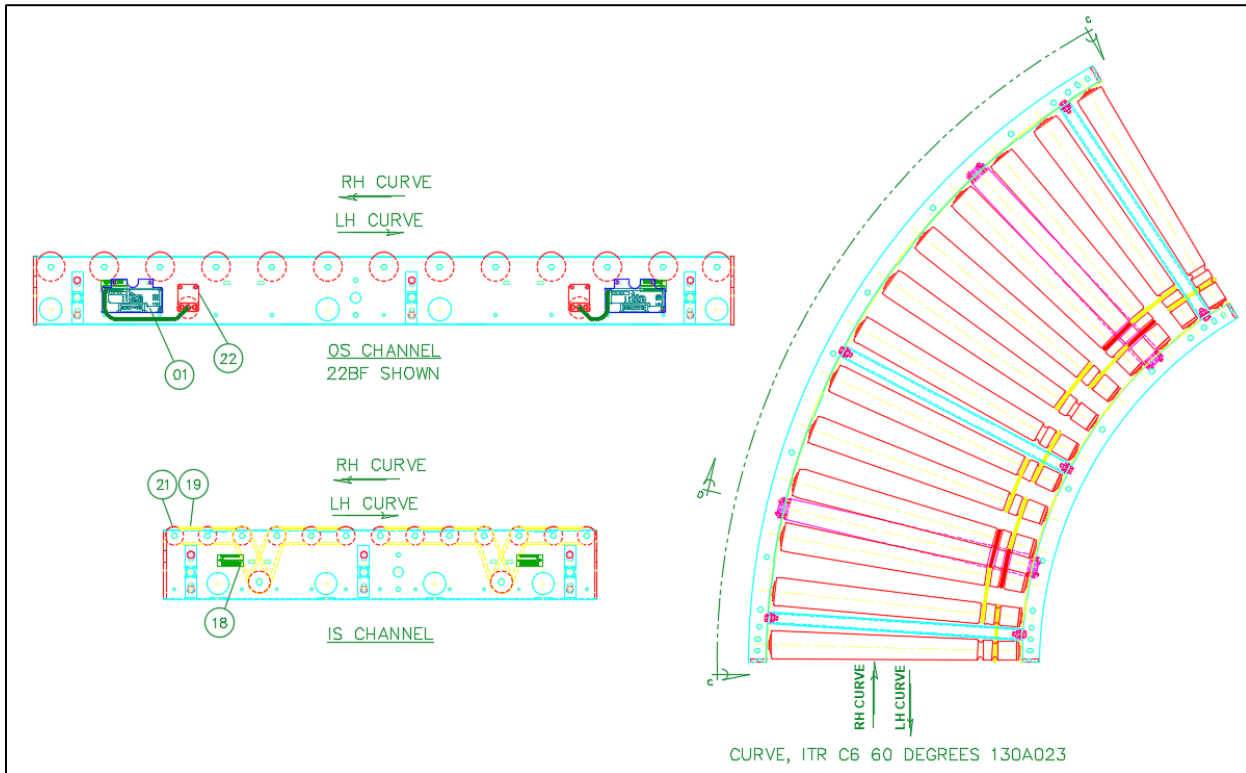

18.23.4 ITR Transportation Curve 90 Degree

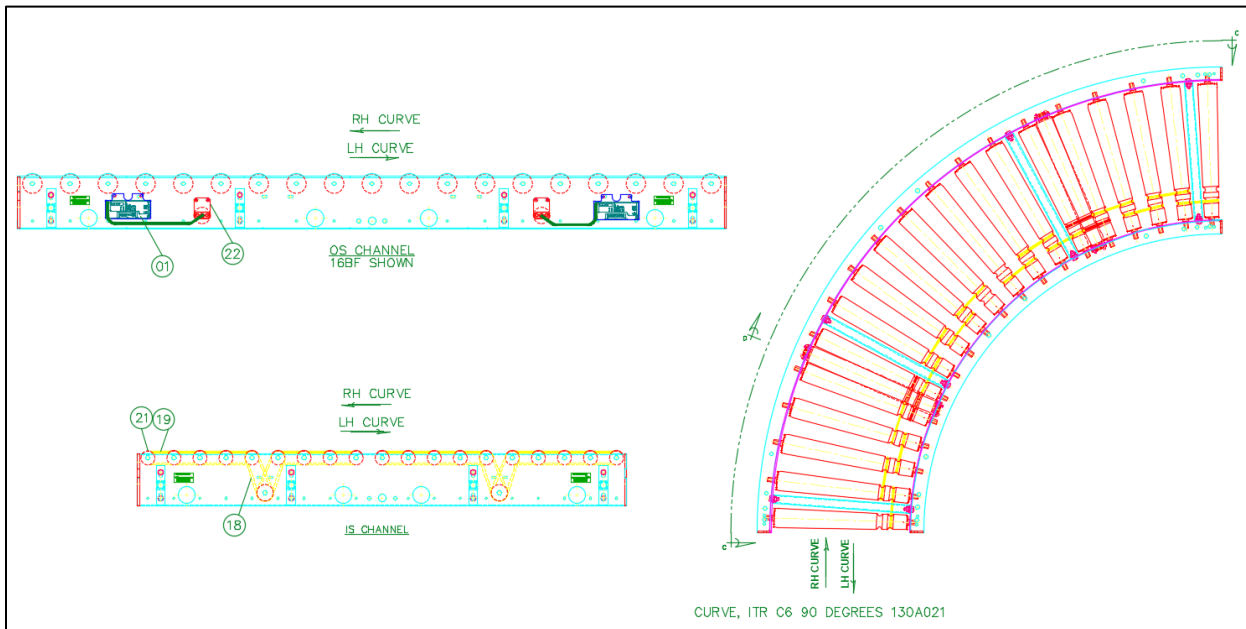

18.23.5 Replacement Parts – ITR Standard Transportation Curves

REPLACEMENT PARTS - ITR TRANSPORTATION CURVES, STANDARD OR HIGH DENSITY ROLLER					
CURVE,ITR-__BF-(CB OR IBE)-C6-(STD OR HDR)-_D-LH/RH-FE60-_MR		Width & Item #			
Balloon	Description	16 BF	22 BF	28 BF	34 BF
---	ELECTRICAL COMPONENTS	---	---	---	---
01	DRIVERCARD,ITOH CB-016P7	1116036	1116036	1116036	1116036
01	DRIVERCARD,ITOH CBM-105FP	1153930	1153930	1153930	1153930
---	HARNESS,POWER BROWN & BLUE (NOT BF SPECIFIC)	3'-0" L 1102289	5'-6" L 1102288	8'-0" L 1102287	10'-6" L 1102286
---	CABLE,POWER CB-016/HB-510 14GA ITR	1139543	1139543	1139543	1139543
---	CONN, 3 COND, W/LEVERS 28 - 12 AWG	1102816	1102816	1102816	1102816
---	CONNECTOR,IDC SCOTCH LOK 558 - RED	1120174	1120174	1120174	1120174
12	CONNECTOR,IDC SCOTCHLOK 567 - BROWN	3M567	3M567	3M567	3M567
---	CURVE, TRANSPORTATION	---	---	---	---
18	ORING,.210" DIA. X 11.5" HT RED MARKED WITH 1 BLACK STRIPE (USED WITH STD)	1102845	1102845	1102845	1102845
19	ORING,.210" DIA X 9.4" HT RED (DURA-BELT) (USED WITH STD)	1102748	1102748	1102748	1102748
18	ORING,.210 DIA X 11.13 HT RED MARKED WITH 1 BLACK STRIPE (USED WITH HDR)	1102711	1102711	1102711	1102711
19	ORING,.210 DIA X 7.5 HT RED (USED WITH HDR)	1185142	1185142	1185142	1185142
21	ROLLER,__ W TT ITR 2 GRV PRBG	E0009900	E0009901	E0009902	E0009903
22	ROLLER,ITR __BF 2G ITOH PM486 FE-60	1138722	1138723	1138724	1138725
22	ROLLER,ITR 13.25BF 2G ITOH PM486FE-140 (USED WITH CB-016)	1168560	1134452	1142856	1155281
Reference Dwg: Trans Curve 130A027, 130A025, 130A023, & 130A021					

18.24 ITR FWB HORIZONTAL / DECLINE BED 24 & 30 ZONES

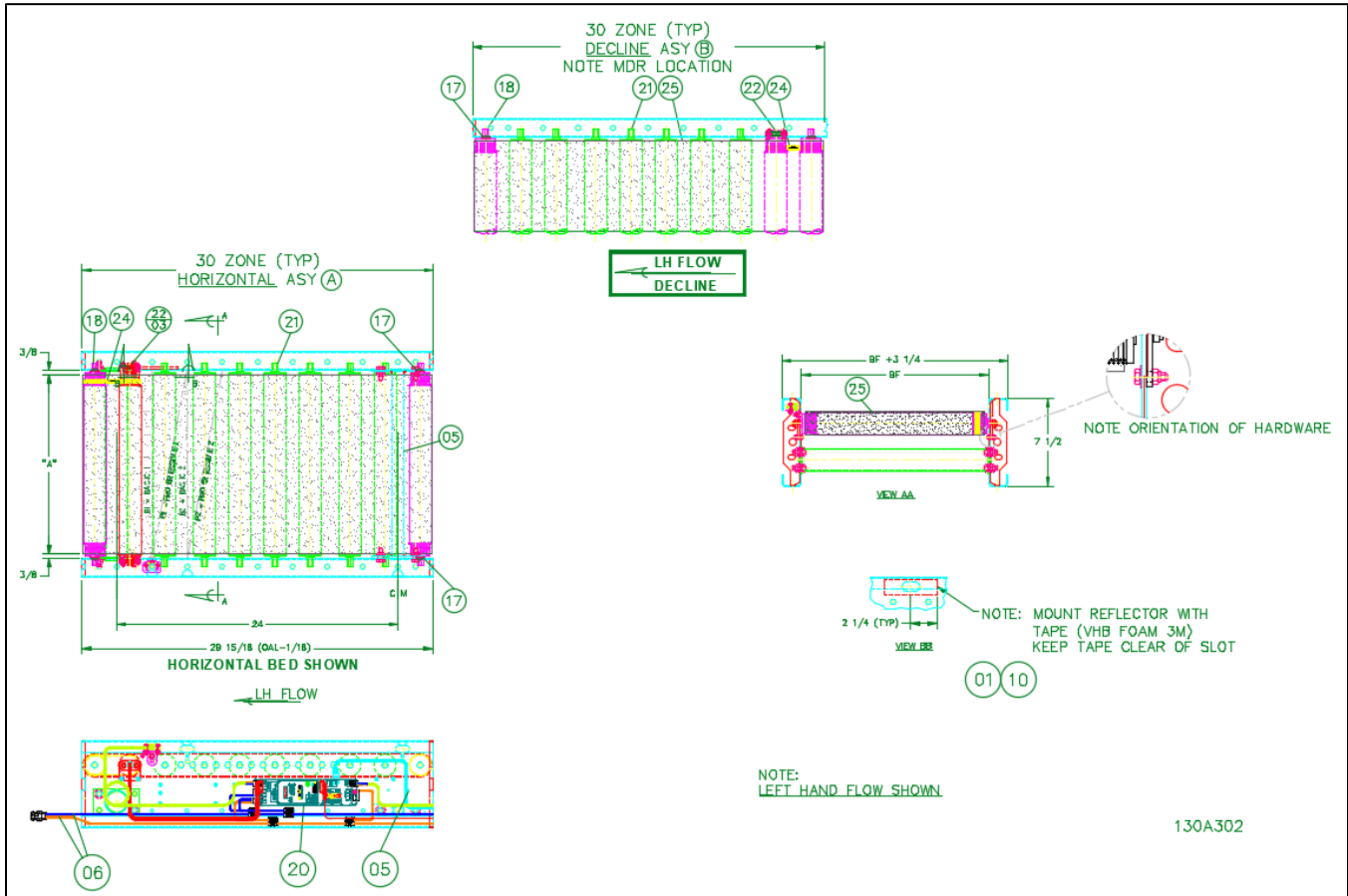

18.24.1 Replacement parts – ITR FWB Horizontal / Decline Bed 24 & 30 Zones

ITR FUL WIDTH BELT CZ HORIZONTAL / DECLINE BED, 30 or 24 ZONE				
BED, ITR-__BF-HORZ / DECLINE-(IBE OR CB)-CZ-FWB-(24Z OR 30Z)-(RH OR LH)		Width & Item #		
Balloon	Description	16 BF	22 BF	28 BF
20	DRIVERCARD, ITOH IB-E03BP	1166286	1166286	1166286
20	DRIVERCARD, ITOH HB-510P	1101261	1101261	1101261
20	DRIVERCARD, ITOH HB-510BP, BRAKE CONTROL	1108863	1108863	1108863
1	PE, REFLEX TYPE ZL, PNP, LIGHT OPERATE (USED WITH IBE)	1163456	1163456	1163456
1	PE, REFLEX TYPE ZL, PNP, DARK OPERATE (USED WITH HB)	1137687	1137687	1137687
10	PE, REFLECTOR 4-3/8" X 1-1/8"	400004	400004	400004
5	CABLE, CTRLS-CAT5E-_-GRAY	DRIVER CARD CAT5E COMMUNICATION CABLES		
6	CABLE, MOTOR EXTENSION, 600, 1200, OR 2700 MM LONG	REFERENCE CABLE, MOTOR EXTENSION USED WITH STATED DRIVER CARD		
17	ORING, 1/2"ID (3/32 WALL)	90530050	90530050	90530050
18	ROLLER, __BF POLY-V 1.9 PRBG 2D W/DURA-BELT POLY-V ENDCAPS	1208809	1208810	1208811
21	ROLLER, __"GRAV 1.9 PLTD PRBG	60218009	60224009	60230009
22/03	ROLLER, ITR __BF VG ITOH (LESS BRAKE USED WITH IBE)	1165463	1165464	1165465
22/03	ROLLER, ITR __BF VG ITOH, BRAKE (WITH BRAKE - USED WITH IBE)	1165467	1165468	1165469
22/03	ROLLER, ITR __BF VG ITOH, BRAKE (WITH BRAKE USED WITH HB)	1153059	1153060	1153061
22/03	ROLLER, ITR __BF VG ITOH (LESS BRAKE USED WITH HB)	1141751	1150242	1145796
24	BELT, ITR 3"CTR POLY-V 4RIB	1142087	1142087	1142087
25	BELT, TRAC .05"X ___"X ___", 30"ZONE (27.75" ROLLER TO ROLLER)	1152477	1152478	1152479
25	BELT, TRAC .05"X ___"X ___", 24"ZONE (21.75" ROLLER TO ROLLER)	1154261	1154262	1154263

Ref Dwg# 130A302

18.25 ITR FWB HORIZONTAL / INCLINE BED 24 & 30 ZONE

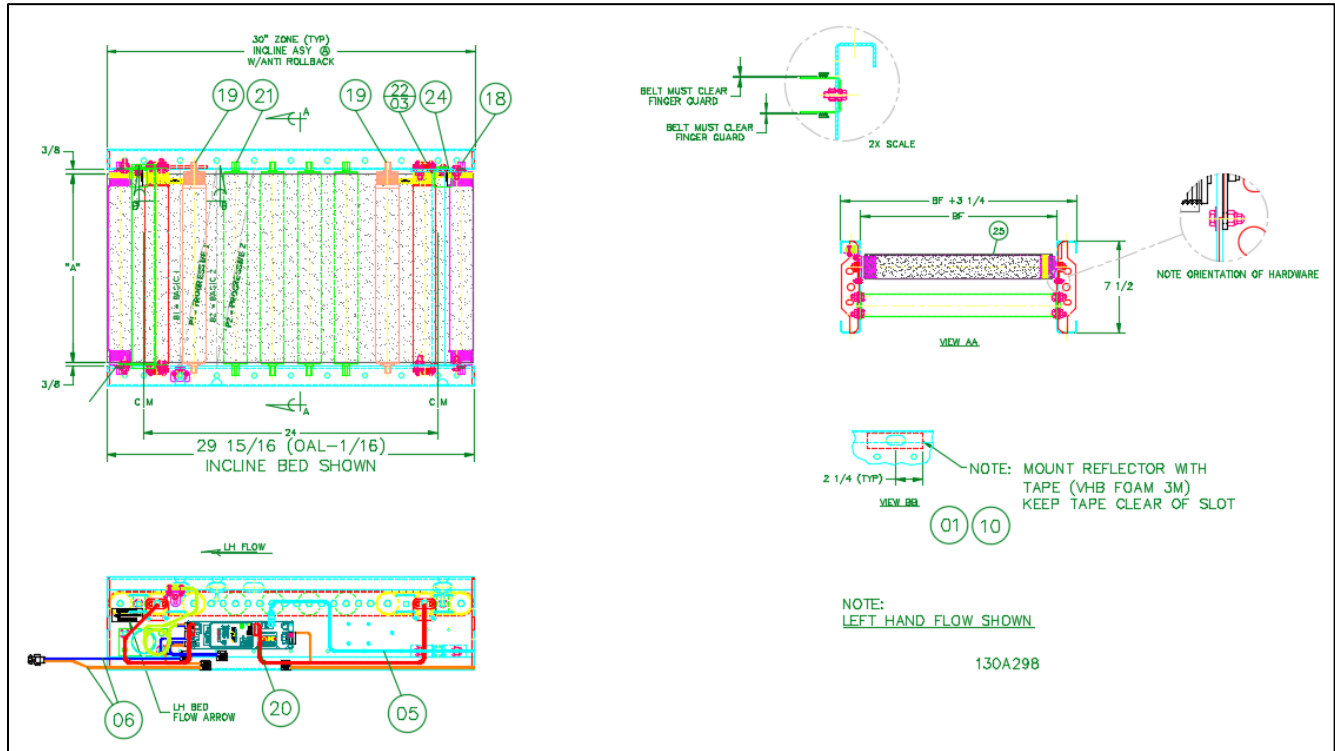

18.25.1 Replacement Parts - ITR FWB Incline Bed 24 & 30 Zone

ITR FUL WIDTH BELT CZ HORIZONTAL / INCLINE BED, 30 or 24 ZONE				
BED, ITR_ _BF-HORZ / INCLINE-(IBE OR HB)-CZ-FWB-(24Z OR 30Z)-(LH or RH)		Width & Item #		
Balloon	Description	16 BF	22 BF	28 BF
20	DRIVERCARD, ITOH IB-E03BP	1166286	1166286	1166286
20	DRIVERCARD, ITOH HB-510P	1101261	1101261	1101261
1	PE, REFLEX TYPE ZL, PNP, LIGHT OPERATE (USED WITH IBE)	1163456	1163456	1163456
1	PE, REFLEX TYPE ZL, PNP, DARK OPERATE (USED WITH HB)	1137687	1137687	1137687
10	PE, REFLECTOR 4-3/8" X 1-1/8"	400004	400004	400004
5	CABLE, CTRLS-CAT5E-_-GRAY	DRIVER CARD CAT5E COMMUNICATION CABLES		
6	CABLE, MOTOR EXTENSION, 600, 1200, OR 2700 MM LONG	REFERENCE CABLE, MOTOR EXTENSION USED WITH STATED DRIVER CARD		
17	ORING, 1/2" ID (3/32 WALL)	90530050	90530050	90530050
18	ROLLER_ _BF POLY-V 1.9 PRBG 2D, W/DURA-BELT POLY-V ENDCAPS	1208809	1208810	1208811
19	ROLLER_ _BF ITR POLYV 1.9PLTD, PRBG ANTI-ROLLBACK CLOCKWISE ROT, (USED WITH LH)	1152607	1152608	1152609
19	ROLLER_ _BF ITR POLYV 1.9PLTD, PRBG ANTI-ROLLBACK COUNTER CLOCKWISE ROT, (USED WITH RH)	1152603	1152604	1152605
21	ROLLER_ _"GRAV 1.9 PLTD PRBG	60218009	60224009	60230009
22/03	ROLLER, ITR_ _BF GV ITOH, (USED WITH IBE)	1166259	1166260	1166261
22/03	ROLLER, ITR_ _BF GV ITOH, (USED WITH HB)	1153205	1153206	1153207
24	BELT, ITR 3"CTR POLY-V 4RIB	1142087	1142087	1142087
25	BELT, TRAC .05"X _ "X48.13" (24"Z)	1154261	1154262	1154263
25	BELT, TRAC .05"X _ "X59.81" (30"Z)	1152477	1152478	1152479

Ref Dwg# 130A298

18.26 NOSEOVER DECLINE (ACCUMULATION)

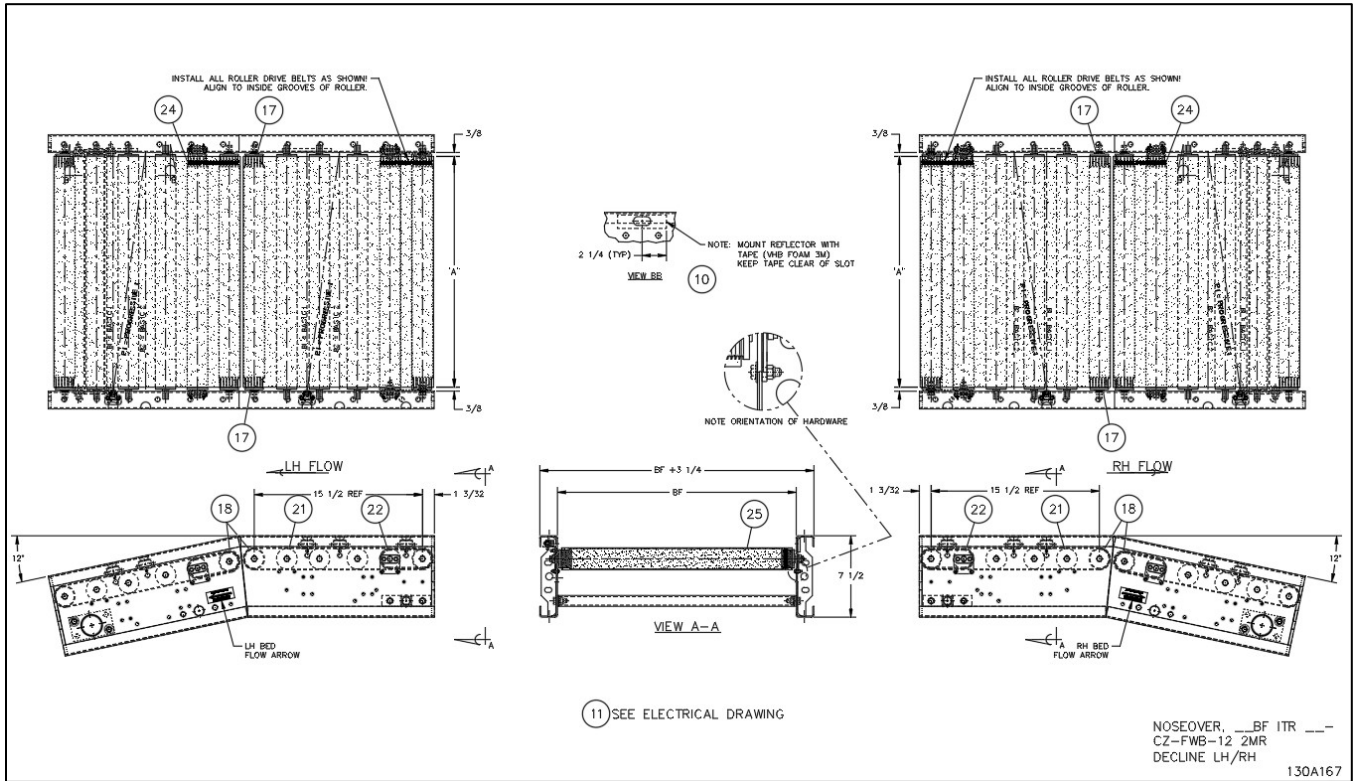

18.26.1 Electrical HB-510 Zones LH/RH Shown

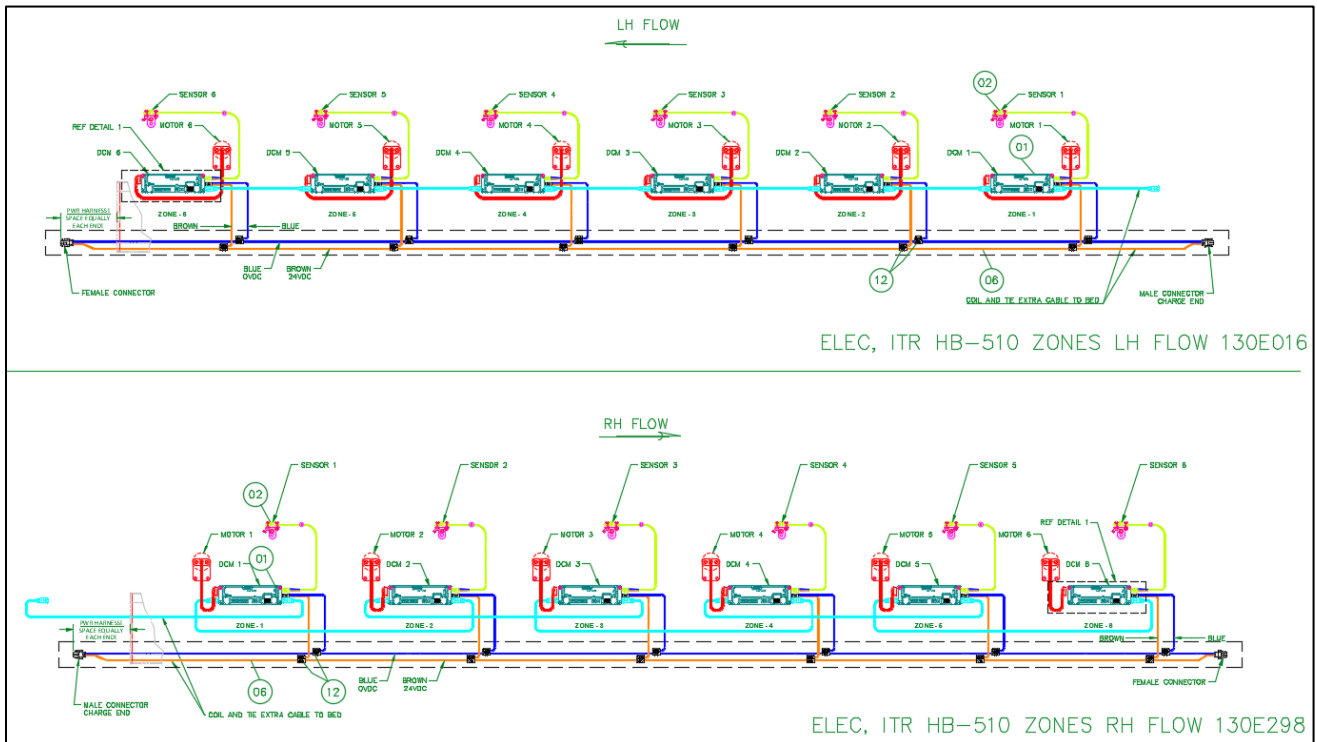

18.26.2 Replacement Parts- Noseover Decline (Accumulation)

REPLACEMENT PARTS - ITR NOSEOVER DECLINE (ACCUMULATION) 9 & 12 DEGREES				
NO,ITR-__BF-DECLINE-(HB OR IBE OR CB)-CZ-FWB-_Z-_D-(LH or RH)-FE60BR		Width & Item #		
Balloon	Description	16 BF	22 BF	28 BF
01	DRIVERCARD,ITOH HB-510BP, BRAKE CONTROL	1108863	1108863	1108863
01	DRIVERCARD,ITOH IB-E03BP	1166286	1166286	1166286
01	DRIVERCARD,ITOH CB-016BP7, PNP - INPUT/OUTPUT SIGNALS, BRAKE CONTROL	1143591	1143591	1143591
02	PE,REFLEX TYPE ZL, PNP, DARK OPERATE (USED WITH HB-510)	1137687	1137686	1137686
02	PE,REFLEX TYPE ZL, PNP,LIGHT OPERATE (USED WITH IBE)	1163456	1163456	1163456
10	PE,REFLECTOR 4-3/8" X 1-1/8"	400004	400004	400004
---	CABLE,CTRLS-CAT5E-_'-GRAY	DRIVER CARD CAT5E COMMUNICATION CABLES		
6	CABLE,MOTOR EXTENSION, 600,1200,OR 2700 MM LONG	REFERENCE CABLE, MOTOR EXTENSION USED WITH STATED DRIVER CARD		
---	CABLE,MOTOR EXTENSION,600MM, 9PIN/10PIN, (USE W/ IB-N03/IB-E/HBM-604)	1135322	1135322	1135322
---	CONNECTOR,IDC SCOTCHLOK 558 - RED	1120174	1120174	1120174
---	CONN, WAGO 231-302/026-000 (USED WITH IBE)	1162204	1162204	1162204
12	CONNECTOR,IDC SCOTCHLOK 567 - BROWN	3M567	3M567	3M567
17	ORING, 1/2"ID (3/32 WALL)	90530050	90530050	90530050
18	ROLLER,__BF POLY-V 1.9 PRBG 2D W/DURA-BELT POLY-V ENDCAPS	1208809	1208810	1208811
21	ROLLER,__"GRAV 1.9 PLTD PRBG	60218009	60224009	60230009
22/03	ROLLER,ITR __BF VG ITOH, BRAKE (WITH BRAKE USED WITH HB)	1153059	1153060	1153061
22/03	ROLLER,ITR __BF VG ITOH,BRAKE (WITH BRAKE - USED WITH IBE)	1165467	1165468	1165469
24	BELT,ITR 3"CTR POLY-V 4RIB	1142087	1142087	1142087
25	BELT,TRAC .08"X__"X36.31", (9 & 12 DEGREES) WVT-463, 2.5% STRCH-RIBBED SIDE UP, __BF-(15 1/2" ROLLER TO ROLLER)	1224264	1224265	1222081

Ref Dwg# 130A167

18.27 NOSEOVER INCLINE (ACCUMULATION)

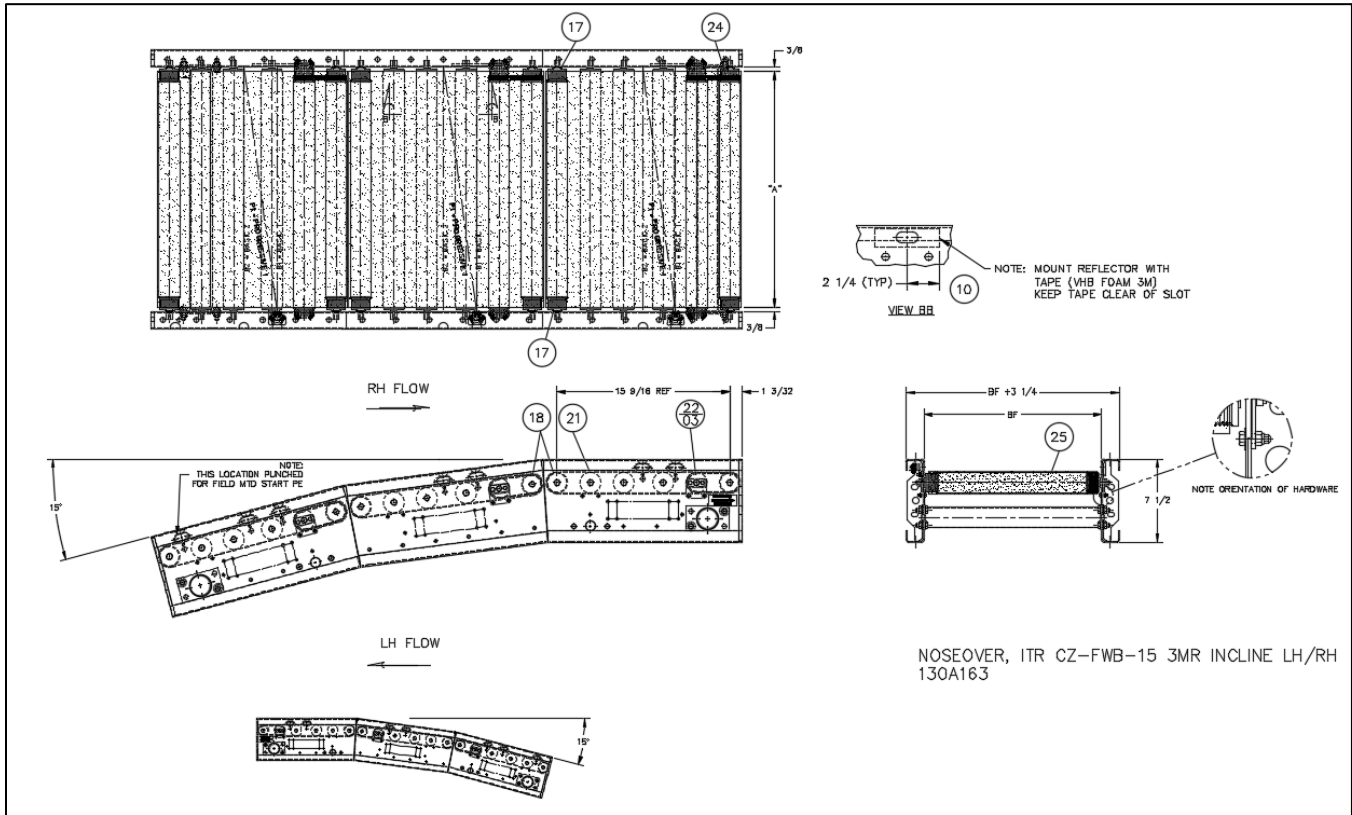

18.27.1 Electrical HB-510 Zones LH/RH Shown

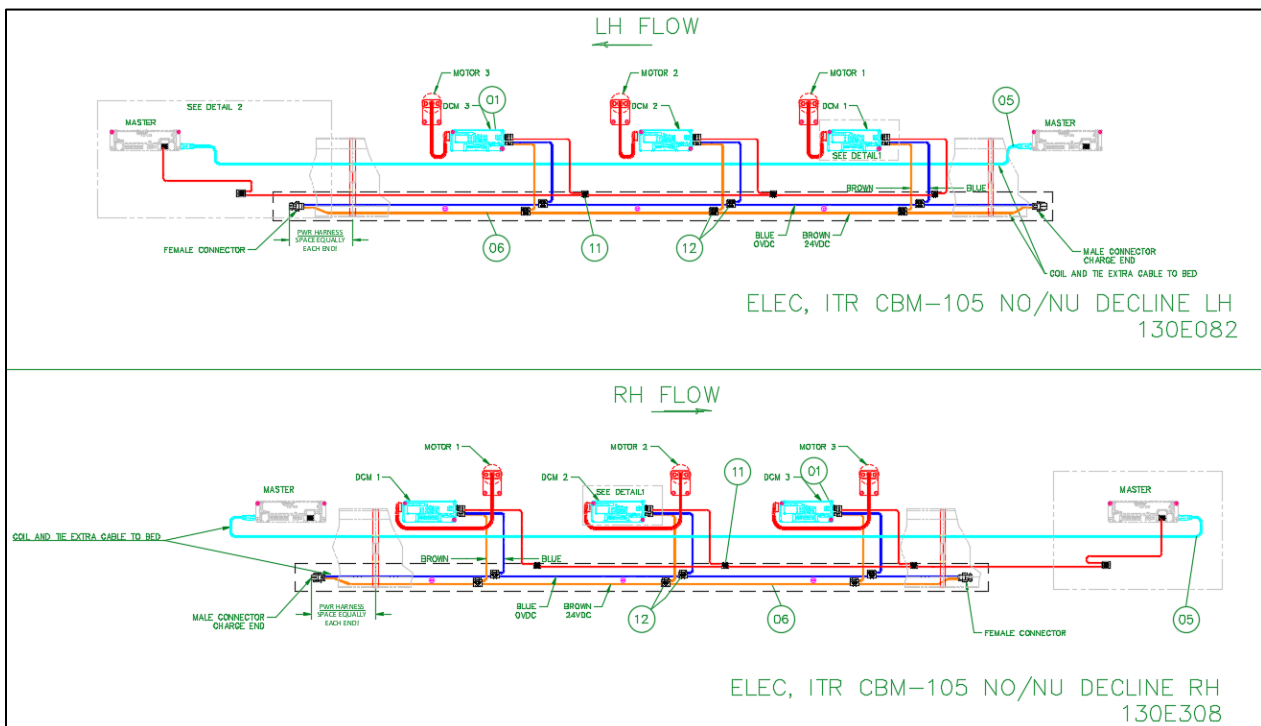

18.27.2 Replacement Parts- Noseover Incline (Accumulation)

REPLACEMENT PARTS - ITR NOSEOVER INCLINE (ACCUMULATION) 9D, 12D, & 15D				
NO,ITR-__BF-INCLINE-(HB OR IBE)-CZ-FWB-_-_-D-(LH OR RH)-FP55		Width & Item #		
Balloon	Description	16 BF	22 BF	28 BF
01	DRIVERCARD,ITOH HB-510P	1101261	1101261	1101261
01	DRIVERCARD,ITOH IB-E03BP	1166286	1166286	1166286
02	PE,REFLEX TYPE ZL, PNP, DARK OPERATE (USED WITH HB-510)	1137687	1137687	1137687
02	PE,REFLEX TYPE ZL, PNP,LIGHT OPERATE (USED WITH IBE)	1163456	1163456	1163456
---	CONN, WAGO 231-302/026-000 (USED WITH IBE)	1162204	1162204	1162204
05	CABLE,CTRLS-CAT5E-_-GRAY	DRIVER CARD CAT5E COMMUNICATION CABLES		
06	CABLE,MOTOR EXTENSION, 600,1200,OR 2700 MM LONG	REFERENCE CABLE, MOTOR EXTENSION USED WITH STATED DRIVER CARD		
10	PE,REFLECTOR 4-3/8" X 1-1/8"	400004	400004	400004
12	CONNECTOR,IDC SCOTCHLOK 567 - BROWN	3M567	3M567	3M567
17	ORING,1/2"ID (3/32 WALL)	90530050	90530050	90530050
18	ROLLER,___BF POLY-V 1.9 PRBG 2D W/DURA-BELT POLY-V ENDCAPS	1208809	1208810	1208811
21	ROLLER,___"GRAV 1.9 PLTD PRBG	60218009	60224009	60230009
22/03	ROLLER,ITR___BF VG ITOH (USED WITH HB)	1153205	1153206	1153207
22/03	ROLLER,ITR___BF GV ITOH (USED WITH IBE)	1166259	1166260	1166261
24	BELT,ITR 3"CTR POLY-V 4RIB	1142087	1142087	1142087
25	BELT,TRAC .08"X___"X36.31", (9 & 12 DEGREES) WVT-463, 2.5% STRCH-RIBBED SIDE UP,___BF-(15 1/2" ROLLER TO ROLLER)	1224264	1224265	1222081
25	BELT,TRAC .08"X___"X36.43" (15 DEGREES) WVT-463, 2.5% STRCH-RIBBED SIDE UP,___BF-(15 9/16" ROLLER TO ROLLER)	1223756	1223252	1223994

REF DWG# 130A163

18.28 NOSEOVER DECLINE (TRANSPORTATION)

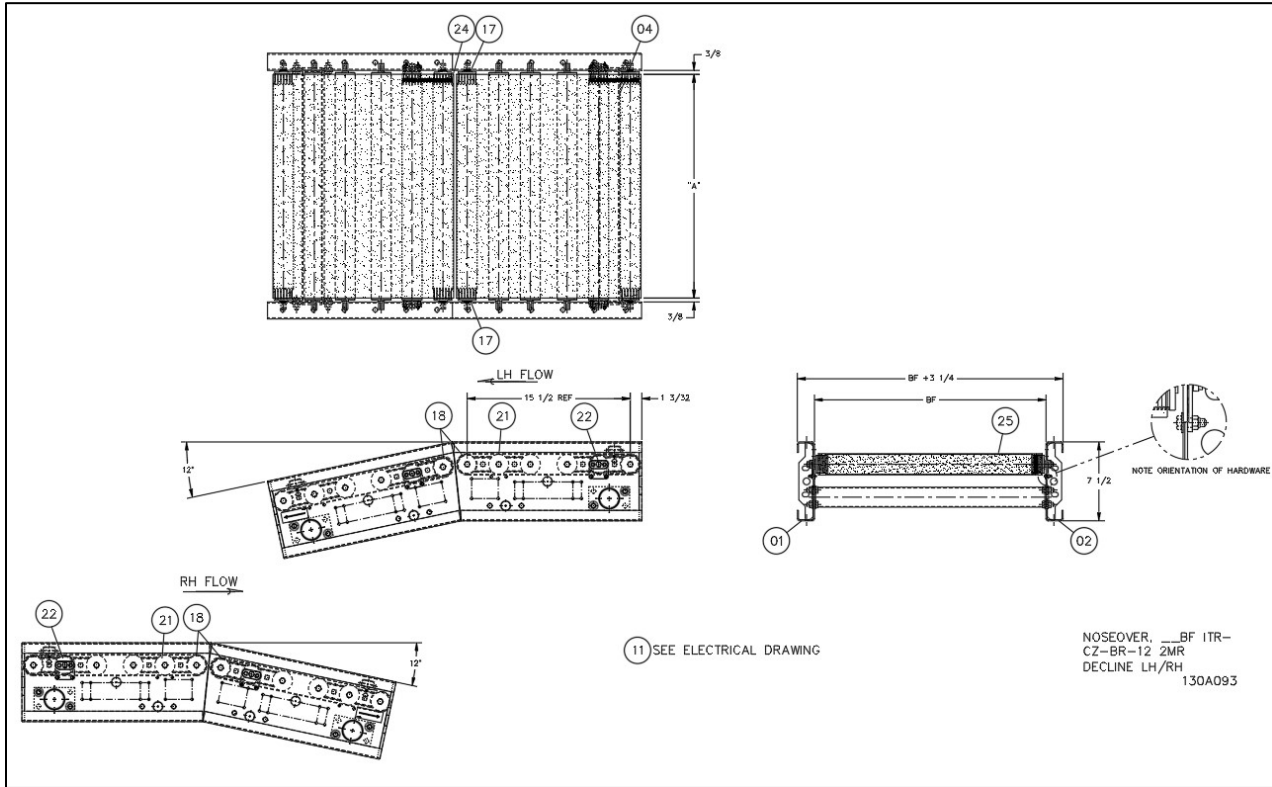

18.28.1 Noseover Decline (Transportation) Electrical CBM-105 Shown

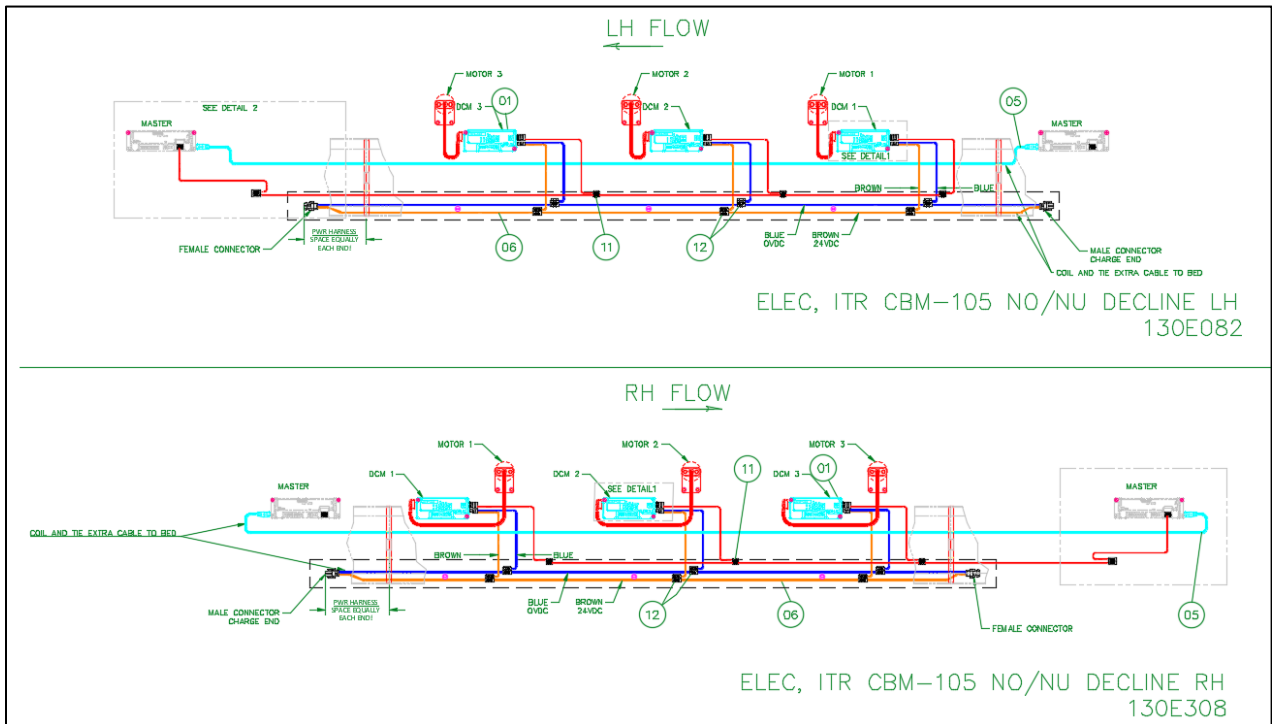

18.28.2 Replacement Parts – Noseover Decline (Transportation)

REPLACEMENT PARTS - ITR NOSEOVER DECLINE (TRANSPORTATION) 9D & 12D				
NO,ITR-__BF-DECLINE-CB-CZ-FWB-__D-(LH OR RH)-FE60		Width & Item #		
Balloon	Description	16 BF	22 BF	28 BF
1	DRIVERCARD,ITOH CBM-105FP	1153930	1153930	1153930
5	CABLE,CTRLS-CAT5E-_-GRAY	DRIVER CARD CAT5E COMMUNICATION CABLES		
06	CABLE,MOTOR EXTENSION, 600,1200,OR 2700 MM LONG	REFERENCE CABLE, MOTOR EXTENSION USED WITH STATED		
11	CONNECTOR,IDC SCOTCH LOK 558 - RED	1120174	1120174	1120174
12	CONNECTOR,IDC SCOTCHLOK 567	3M567	3M567	3M567
---	CONN, 3 COND, W/LEVERS	1102816	1102816	1102816
17	ORING,1/2"ID (3/32 WALL)	90530050	90530050	90530050
18	ROLLER,__BF POLY-V 1.9 PRBG 2D, W/DURA-BELT POLY-V ENDCAPS	1208809	1208810	1208811
21	ROLLER,__"GRAV 1.9 PLTD PRBG	60218009	60224009	60230009
22/03	ROLLER,ITR __BF VG ITOH	1141751	1150242	1145796
24	BELT,ITR 3"CTR POLY-V 4RIB	1142087	1142087	1142087
25	BELT,TRAC .08"X__"X36.31", (9 & 12 DEGREES) WVT-463, 2.5% STRCH-RIBBED SIDE UP,__BF-(15 1/2" ROLLER TO ROLLER)	1224264	1224265	1222081

Ref Dwg# 130A093

18.29 NOSEOVER INCLINE (TRANSPORTATION)

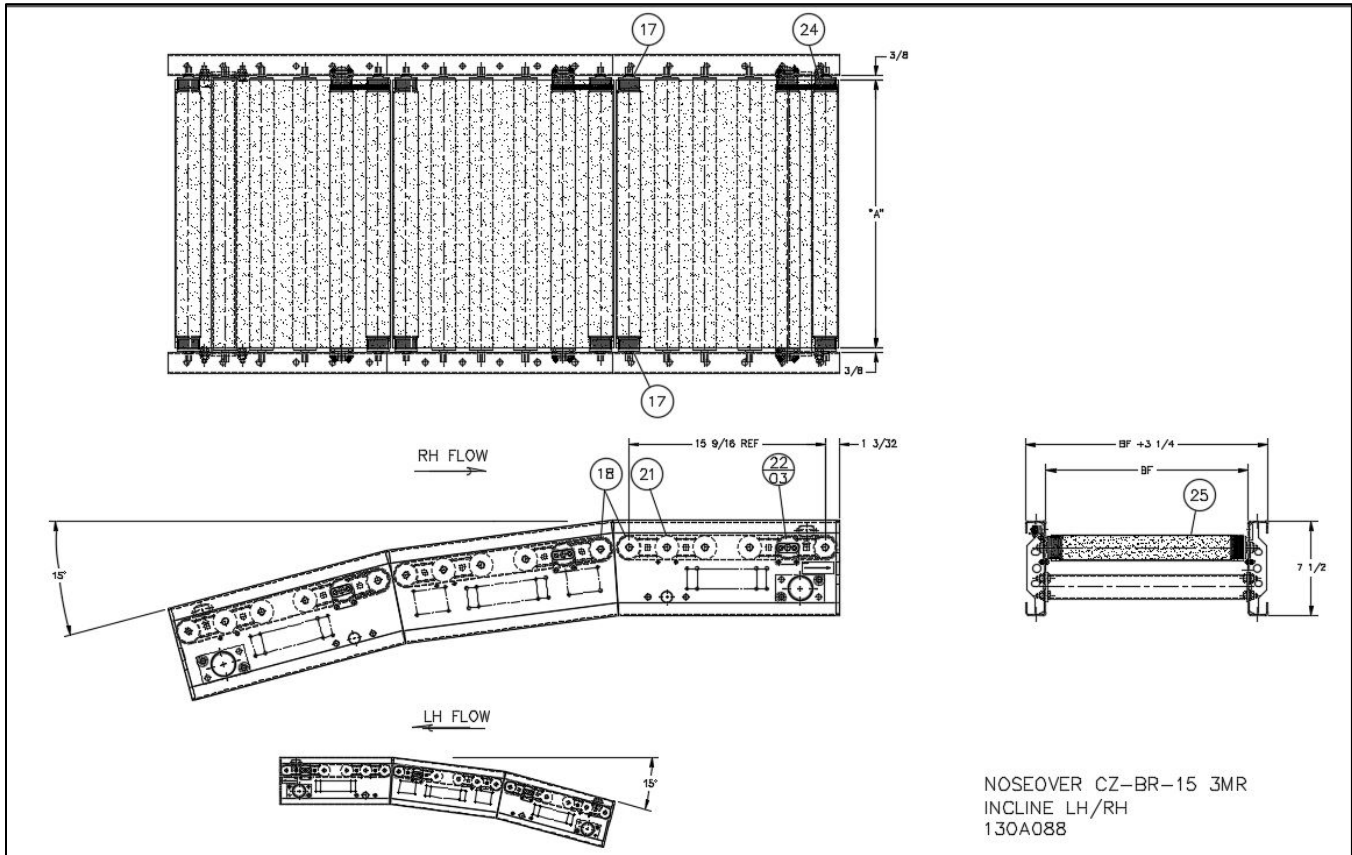

18.29.1 Noseover Incline (Transportation) Electrical CBM-105 Shown

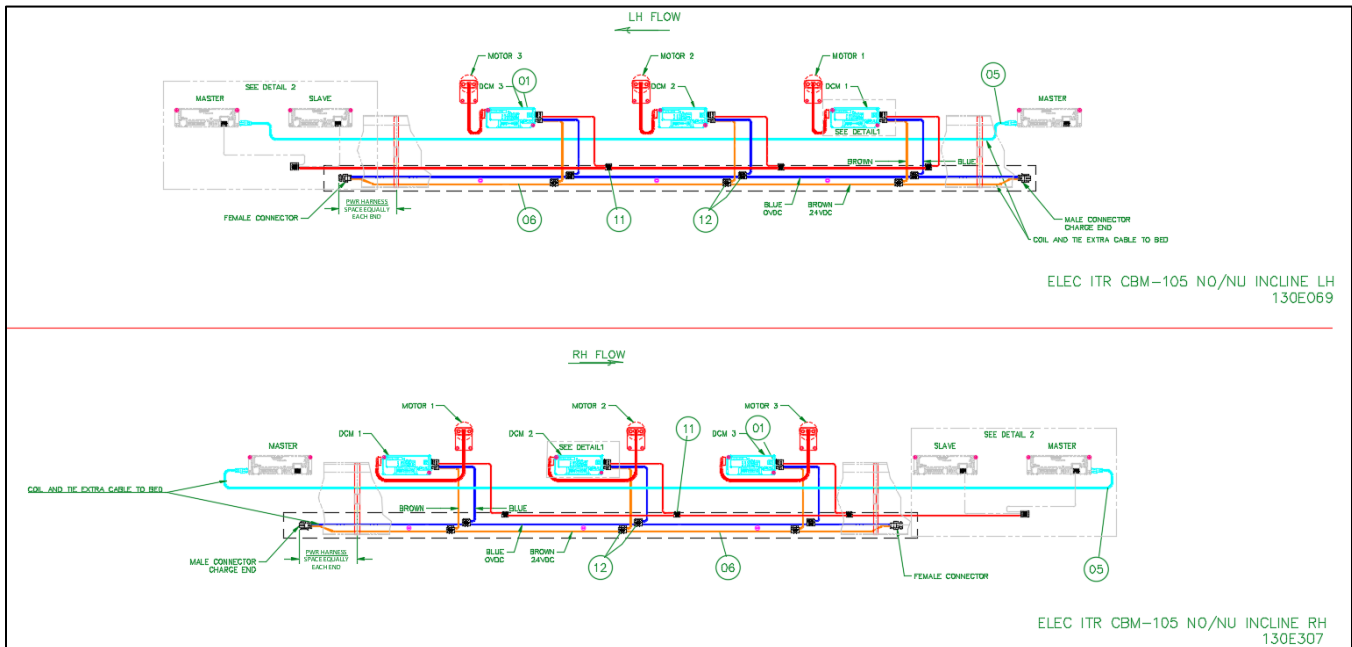

18.29.2 Replacement Parts – Noseover Incline (Transportation)

REPLACEMENT PARTS - ITR NOSEOVER INCLINE (TRANSPORTATION) 9D, 12D, & 15D				
NO, ITR-__BF-INCLINE-CB-CZ-FWB-__D-(LH OR RH)-FP55		Width & Item #		
Balloon	Description	16 BF	22 BF	28 BF
1	DRIVERCARD, ITOH CBM-105FP	1153930	1153930	1153930
5	CABLE, CTRLS-CAT5E-'-GRAY	DRIVER CARD CAT5E COMMUNICATION CABLES		
6	CABLE, MOTOR EXTENSION, 600, 1200, OR 2700 MM LONG	REFERENCE CABLE, MOTOR EXTENSION USED WITH STATED DRIVER CARD		
11	CONNECTOR, IDC SCOTCH LOK 558 - RED	1120174	1120174	1120174
12	CONNECTOR, IDC SCOTCHLOK 567	3M567	3M567	3M567
---	CONN, 3 COND, W/LEVERS	1102816	1102816	1102816
17	ORING, 1/2"ID (3/32 WALL)	90530050	90530050	90530050
18	ROLLER, __BF POLY-V 1.9 PRBG 2D, W/DURA-BELT POLY-V ENDCAPS	1208809	1208810	1208811
21	ROLLER, __"GRAV 1.9 PLTD PRBG	60218009	60224009	60230009
22/03	ROLLER, ITR __BF VG ITOH	1153205	1153206	1153207
24	BELT, ITR 3"CTR POLY-V 4RIB	1142087	1142087	1142087
25	BELT, TRAC .08"X__"X36.31", (9 & 12 DEGREES) WVT-463, 2.5% STRCH-RIBBED SIDE UP, __BF-(15 1/2" ROLLER TO ROLLER)	1224264	1224265	1222081
25	BELT, TRAC .08"X__"X36.43" (15 DEGREES) WVT-463, 2.5% STRCH-RIBBED SIDE UP, __BF-(15 9/16" ROLLER TO ROLLER)	1223756	1223252	1223994

Ref Dwg# 130A088

18.30 NOSEUNDER DECLINE (ACCUMULATION)

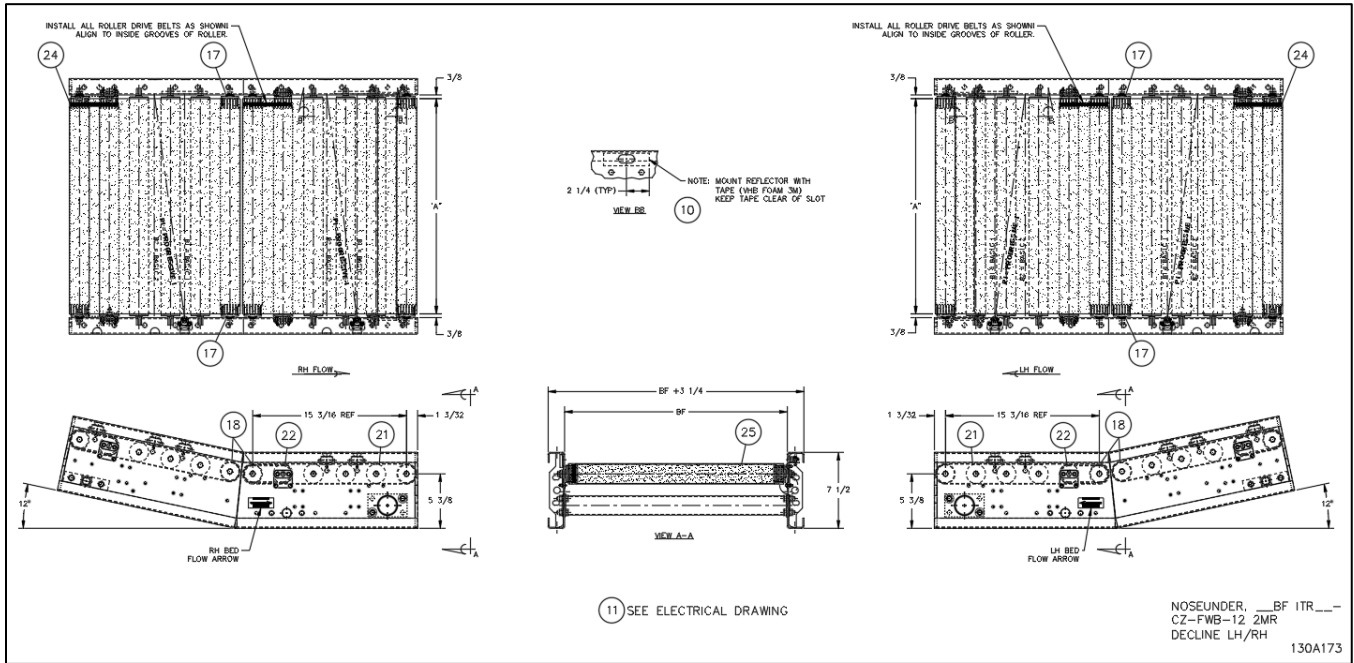

18.30.1 Electrical HB-510 Zones LH/RH Shown

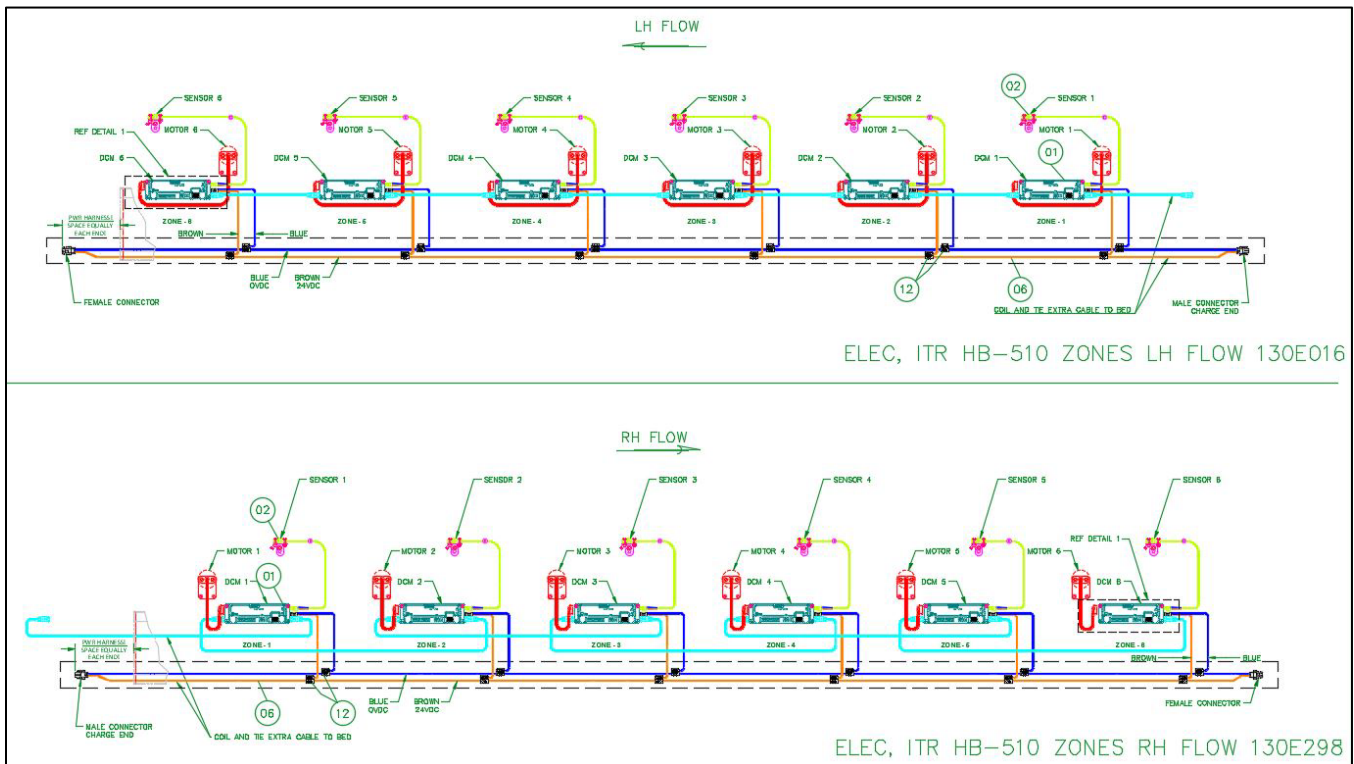

18.30.2 Replacement Parts – Noseunder Decline (Accumulation)

REPLACEMENT PARTS - ITR NOSEUNDER DECLINE (ACCUMULATION) 9 & 12 DEGREES				
NU,ITR-__BF-DECLINE-(HB OR IBE)-CZ-FWB-Z-D-(LH or RH)-FE60BR		Width & Item #		
Balloon	Description	16 BF	22 BF	28 BF
01	DRIVERCARD,ITOH HB-510BP, BRAKE CONTROL	1108863	1108863	1108863
01	DRIVERCARD,ITOH IB-E03BP	1166286	1166286	1166286
01	DRIVERCARD,ITOH CB-016BP7, PNP - INPUT/OUTPUT SIGNALS, BRAKE CONTROL	1143591	1143591	1143591
02	PE,REFLEX TYPE ZL, PNP,LIGHT OPERATE (USED WITH IBE)	1163456	1163456	1163456
02	PE,REFLEX TYPE ZL, PNP, DARK OPERATE (USED WITH HB)	1137687	1137687	1137687
10	PE,REFLECTOR 4-3/8" X 1-1/8"	400004	400004	400004
---	CABLE,CTRLS-CAT5E-_-GRAY	DRIVER CARD CAT5E COMMUNICATION CABLES		
6	CABLE,MOTOR EXTENSION, 600,1200,OR 2700 MM LONG	REFERENCE CABLE, MOTOR EXTENSION USED WITH STATED DRIVER CARD		
---	CONN, WAGO 231-302/026-000 (USED WITH IBE)	1162204	1162204	1162204
12	CONNECTOR,IDC SCOTCHLOK 567 - BROWN	3M567	3M567	3M567
17	ORING,1/2"ID (3/32 WALL)	90530050	90530050	90530050
18	ROLLER,___BF POLY-V 1.9 PRBG 2D W/DURA-BELT POLY-V ENDCAPS	1208809	1208810	1208811
21	ROLLER,___"GRAV 1.9 PLTD PRBG	60218009	60224009	60230009
22/03	ROLLER,ITR ___BF VG ITOH, BRAKE (WITH BRAKE USED WITH HB)	1153059	1153060	1153061
22/03	ROLLER,ITR ___BF VG ITOH,BRAKE (WITH BRAKE - USED WITH IBE)	1165467	1165468	1165469
24	BELT,ITR 3"CTR POLY-V 4RIB	1142087	1142087	1142087
25	BELT,TRAC .08"X___"X35.70" (USED WITH 9 & 12 DEGREES) WVT-463, 2.5% STRCH-RIBBED SIDE UP,___BF-(15 3/16" ROLLER TO ROLLER)	1224264	1224265	1222081

Ref Dwg# 130A173

18.31 NOSEUNDER INCLINE (ACCUMULATION)

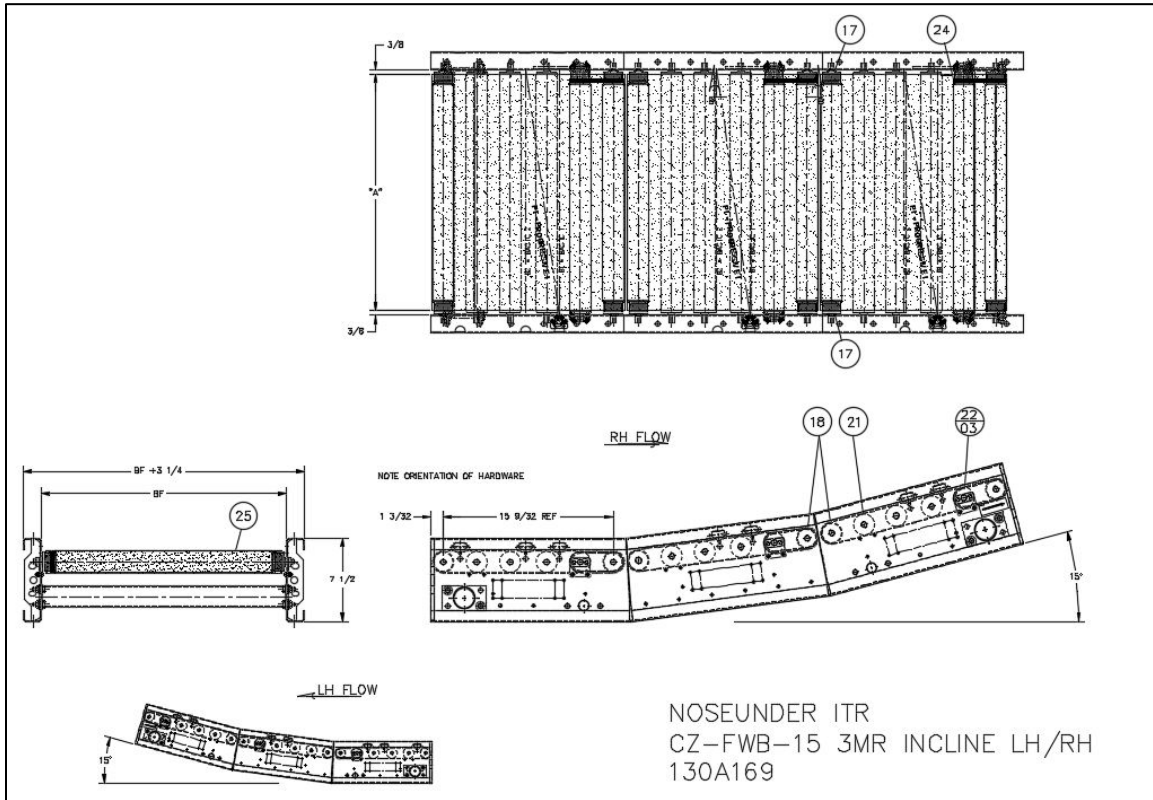

18.31.1 Electrical HB-510 Zones LH/RH Shown

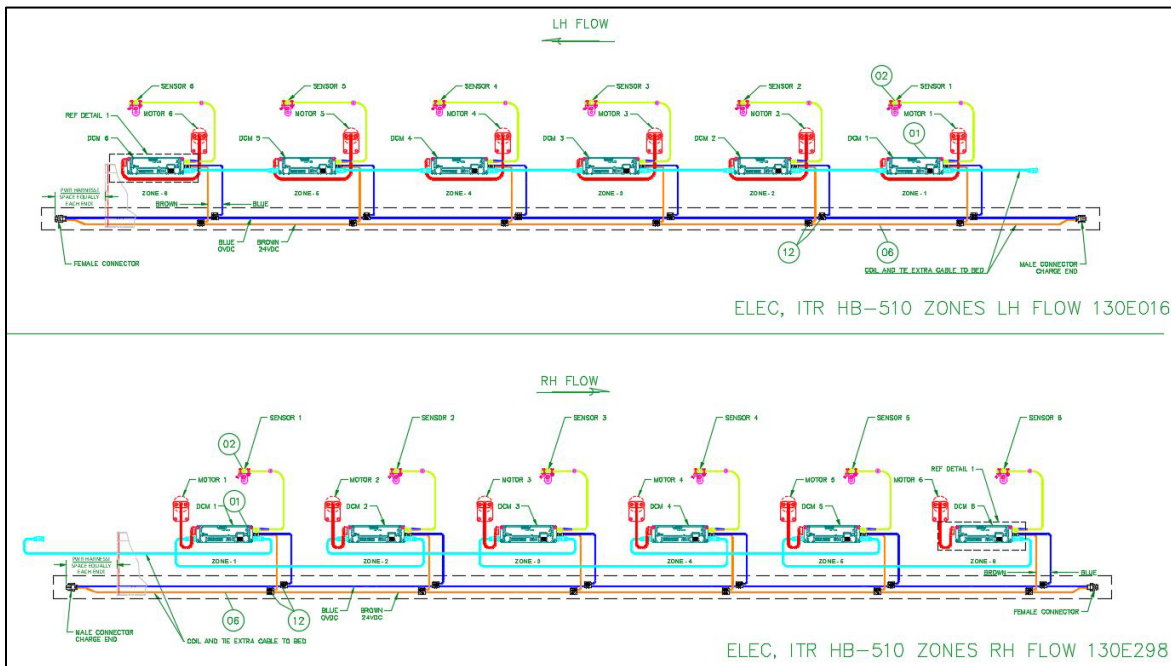

18.31.2 Replacement Parts – Noseunder Incline (Accumulation)

REPLACEMENT PARTS - ITR NOSEUNDER INCLINE (ACCUMULATION) 9D, 12D, & 15D				
NU,ITR-__BF-INCLINE-(HB OR IBE)-CZ-FWB-_-_-D-(LH OR RH)-FP55		Width & Item #		
Balloon	Description	16 BF	22 BF	28 BF
01	DRIVERCARD,ITOH HB-510P	1101261	1101261	1101261
01	DRIVERCARD,ITOH CBM-105FP	1153930	1153930	1153930
01	DRIVERCARD,ITOH IB-E03BP	1166286	1166286	1166286
02	PE,REFLEX TYPE ZL, PNP,LIGHT OPERATE (USED WITH IBE)	1163456	1163456	1163456
02	PE,REFLEX TYPE ZL, PNP, DARK OPERATE (USED WITH HB)	1137687	1137687	1137687
---	PE,REFLECTOR 4-3/8" X 1-1/8"	400004	400004	400004
5	CABLE,CTRLS-CAT5E-_-GRAY	DRIVER CARD CAT5E COMMUNICATION CABLES		
8	CABLE,MOTOR EXTENSION, 600,1200,OR 2700 MM LONG	REFERENCE CABLE, MOTOR EXTENSION USED WITH STATED DRIVER CARD		
---	CONN, WAGO 231-302/026-000 (USED WITH IBE)	1162204	1162204	1162204
12	CONNECTOR,IDC SCOTCHLOK 567 - BROWN	3M567	3M567	3M567
17	ORING,1/2"ID (3/32 WALL)	90530050	90530050	90530050
18	ROLLER,_-BF POLY-V 1.9 PRBG 2D W/DURA-BELT POLY-V ENDCAPS	1208809	1208810	1208811
21	ROLLER,_-GRAV 1.9 PLTD PRBG	60218009	60224009	60230009
22/03	ROLLER,ITR_-BF VG ITOH (USED WITH HB)	1153205	1153206	1153207
22/03	ROLLER,ITR_-BF GV ITOH (USED WITH IBE)	1166259	1166260	1166261
24	BELT,ITR 3"CTR POLY-V 4RIB	1142087	1142087	1142087
25	BELT,TRAC .08"X_-X35.70" (USED WITH 9 & 12 DEGREES) WVT-463, 2.5% STRCH-RIBBED SIDE UP,_-BF-(15 3/16" ROLLER TO ROLLER)	1224300	1224298	1222071
25	BELT,TRAC .08"X_-X35.88" (USED WITH 9 & 15 DEGREES) WVT-463, 2.5% STRCH-RIBBED SIDE UP,_-BF-(15 9/32" ROLLER TO ROLLER)	1224301	1224299	1222072

Ref Dwg# 130A169

18.32 NOSEUNDER DECLINE (TRANSPORTATION)

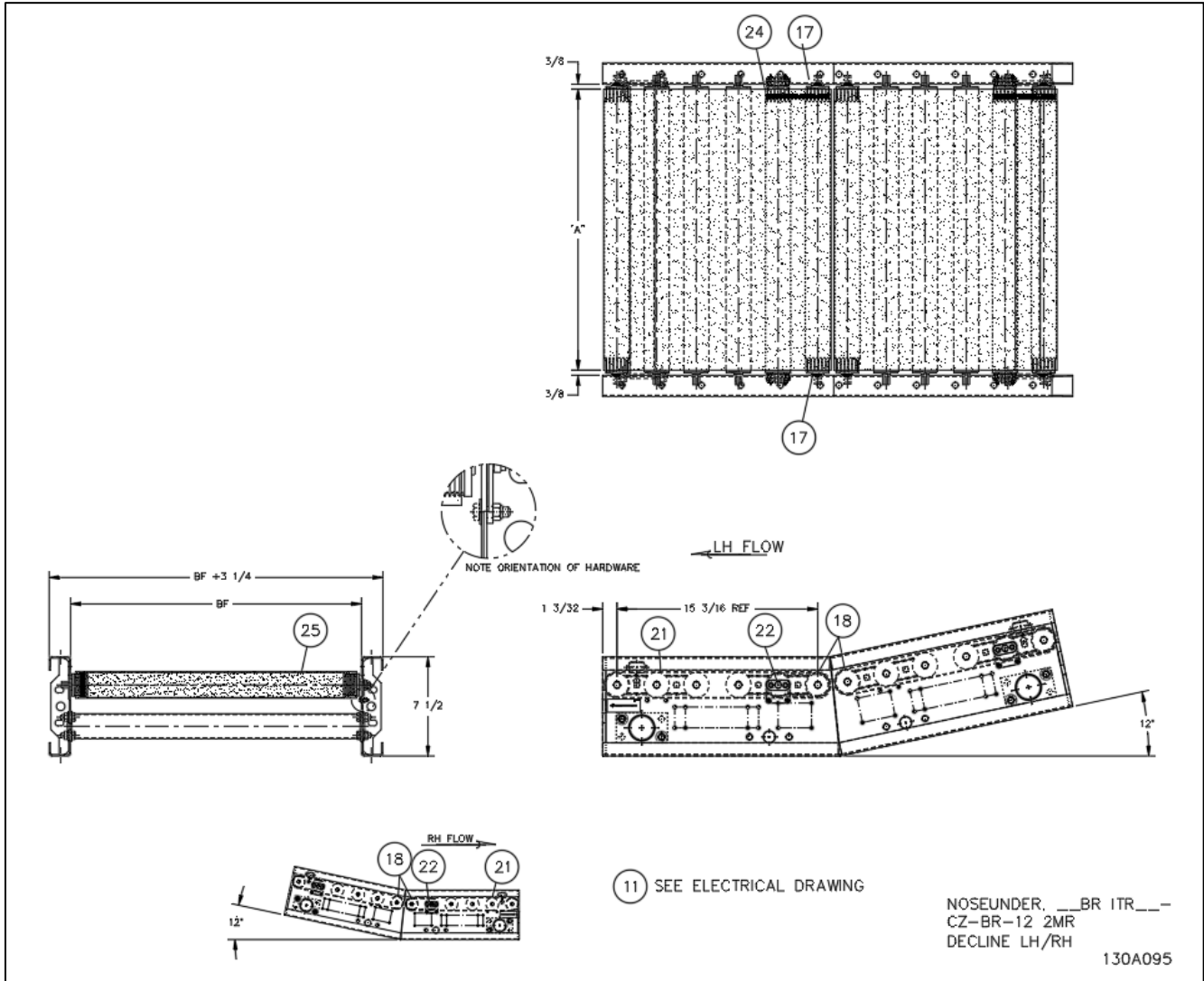

18.32.1 Noseunder Decline (Transportation) Electrical CBM-105 Shown

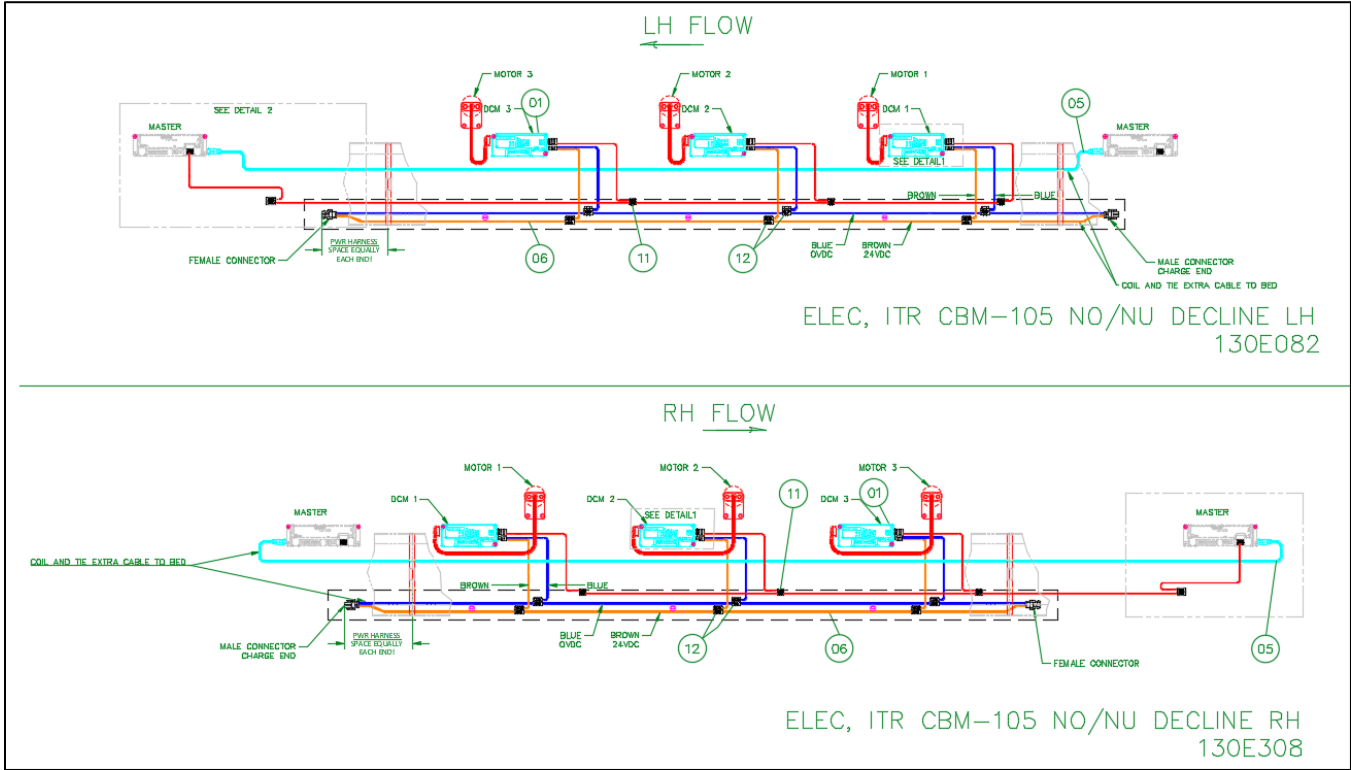

18.32.2 Replacement Parts – Noseunder Decline (Transportation)

REPLACEMENT PARTS - ITR NOSEUNDER DECLINE (TRANSPORTATION) 9 & 12 DEGREES				
NU,ITR-__BF-DECLINE-CB-CZ-FWB-__D-(LH OR RH)-FE60		Width & Item #		
Balloon	Description	16 BF	22 BF	28 BF
1	DRIVERCARD,ITOH CBM-105FP	1153930	1153930	1153930
5	CABLE,CTRLS-CAT5E-_'-GRAY	DRIVER CARD CAT5E COMMUNICATION CABLES		
6	CABLE,MOTOR EXTENSION, 600,1200,OR 2700 MM LONG	REFERENCE CABLE, MOTOR EXTENSION USED WITH STATED DRIVER CARD		
11	CONNECTOR,IDC SCOTCH LOK 558 - RED	1120174	1120174	1120174
12	CONNECTOR,IDC SCOTCHLOK 567	3M567	3M567	3M567
---	CONN, 3 COND, W/LEVERS	1102816	1102816	1102816
17	ORING,1/2"ID (3/32 WALL)	90530050	90530050	90530050
18	ROLLER,__BF POLY-V 1.9 PRBG 2D, W/DURA-BELT POLY-V ENDCAPS	1208809	1208810	1208811
21	ROLLER,__"GRAV 1.9 PLTD PRBG	60218009	60224009	60230009
22	ROLLER,ITR __BF VG ITOH	1141751	1150242	1145796
24	BELT,ITR 3"CTR POLY-V 4RIB	1142087	1142087	1142087
25	BELT,TRAC .08"X__"X35.70" (USED WITH 9 & 12 DEGREES) WVT-463, 2.5% STRCH-RIBBED SIDE UP,__BF-(15 3/16" ROLLER TO ROLLER)	1224300	1224298	1222071

Ref Dwg# 130A095

18.33 NOSEUNDER INCLINE (TRANSPORTATION)

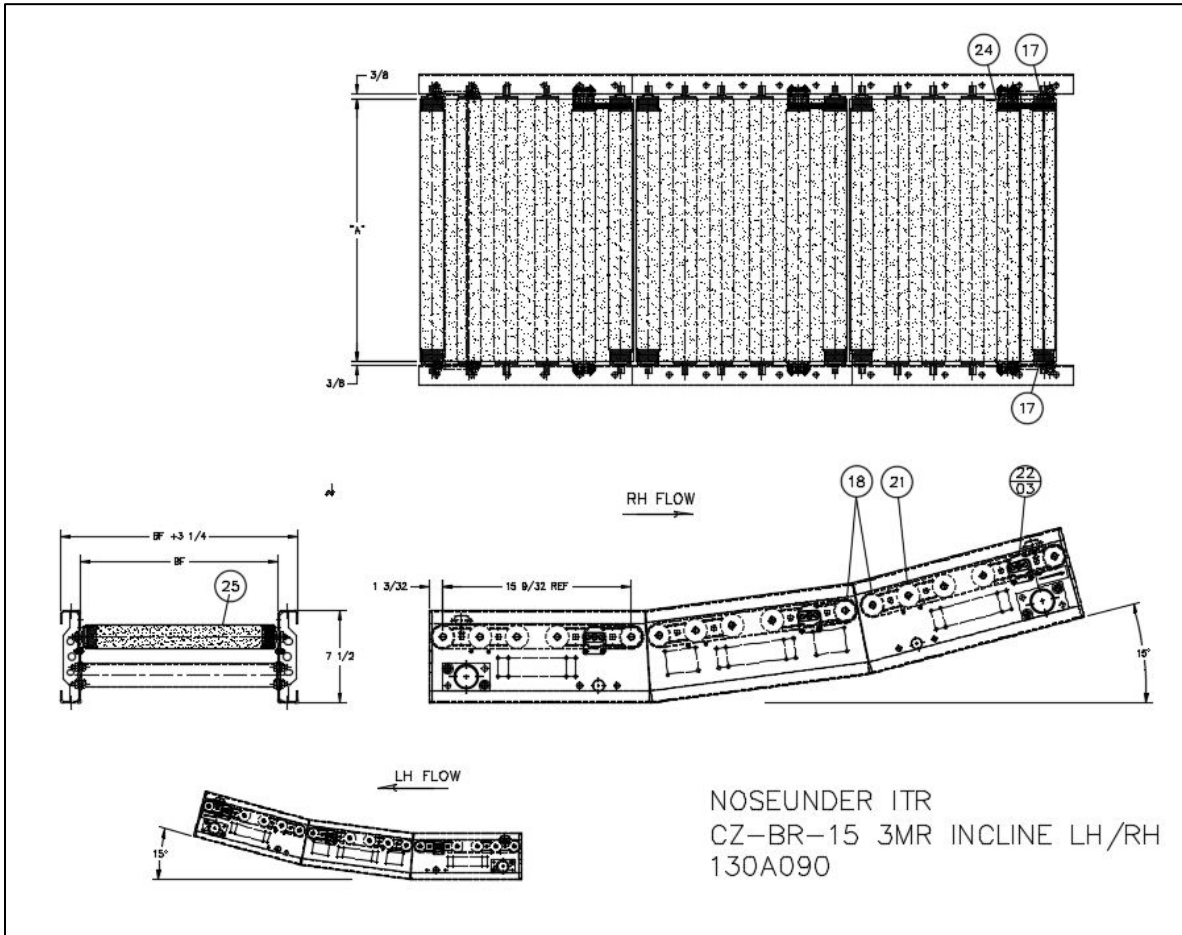

18.33.1 Noseunder Incline (Transportation) Electrical CBM-105 Shown

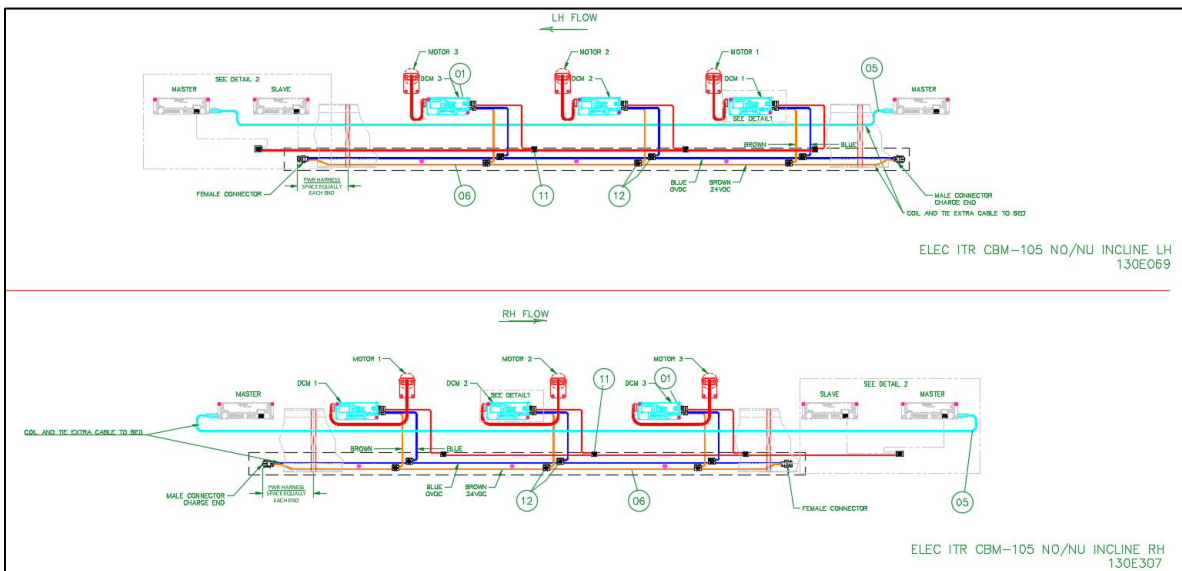

18.33.2 Replacement Parts – Noseunder Incline (Transportation)

REPLACEMENT PARTS - ITR NOSEUNDER INCLINE (TRANSPORTATION) 9D, 12D, & 15D				
NU, ITR-__BF-INCLINE-CB-CZ-FWB-__D-(LH OR RH)-FP55		Width & Item #		
Balloon	Description	16 BF	22 BF	28 BF
1	DRIVERCARD, ITOH CBM-105FP	1153930	1153930	1153930
5	CABLE, CTRLS-CAT5E- '-GRAY	DRIVER CARD CAT5E COMMUNICATION CABLES		
6	CABLE, MOTOR EXTENSION, 600, 1200, OR 2700 MM LONG	REFERENCE CABLE, MOTOR EXTENSION USED WITH STATED DRIVER CARD		
11	CONNECTOR, IDC SCOTCH LOK 558 - RED	1120174	1120174	1120174
12	CONNECTOR, IDC SCOTCHLOK 567	3M567	3M567	3M567
--	CONN, 3 COND, W/LEVERS	1102816	1102816	1102816
17	ORING, 1/2"ID (3/32 WALL)	90530050	90530050	90530050
18	ROLLER, __BF POLY-V 1.9 PRBG 2D, W/DURA-BELT POLY-V ENDCAPS	1208809	1208810	1208811
21	ROLLER, __"GRAV 1.9 PLTD PRBG	60218009	60224009	60230009
22/03	ROLLER, ITR __BF VG ITOH	1153205	1153206	1153207
24	BELT, ITR 3"CTR POLY-V 4RIB	1142087	1142087	1142087
25	BELT, TRAC .08"X__"X35.70" (USED WITH 9 & 12 DEGREES) WVT-463, 2.5% STRCH-RIBBED SIDE UP, __BF-(15 3/16" ROLLER TO ROLLER)	1224300	1224298	1222071
25	BELT, TRAC .08"X__"X35.88" (USED WITH 9 & 15 DEGREES) WVT-463, 2.5% STRCH-RIBBED SIDE UP, __BF-(15 9/32" ROLLER TO ROLLER)	1224301	1224299	1222072

Ref Dwg# 130A090

18.34 ITR SPUR TRANSPORTATION 30 DEGREE

18.34.1 ITR Spur, 16BF, 3RC, 30 Degree

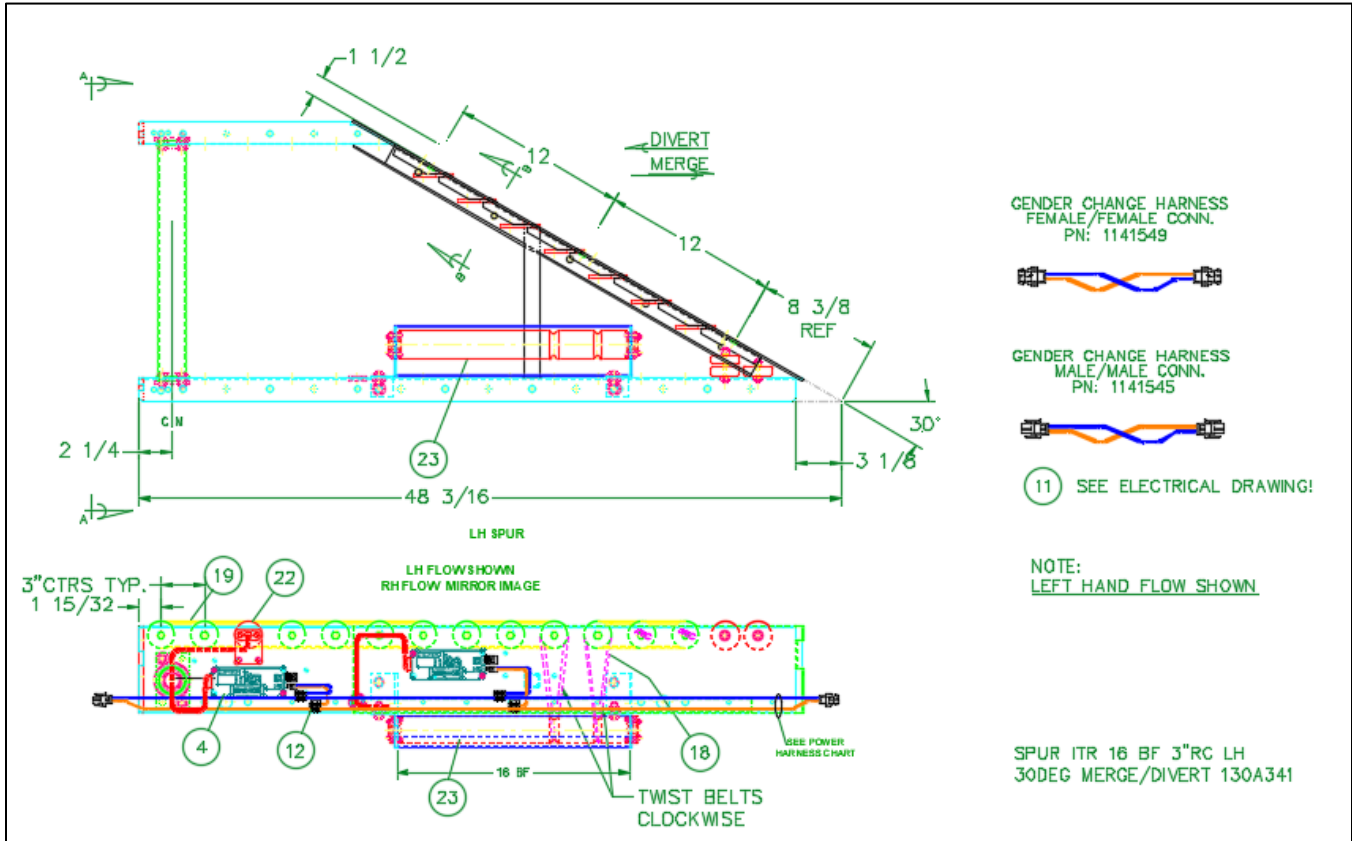

18.34.2 ITR Spur, 22BF, 3RC, 30 Degree

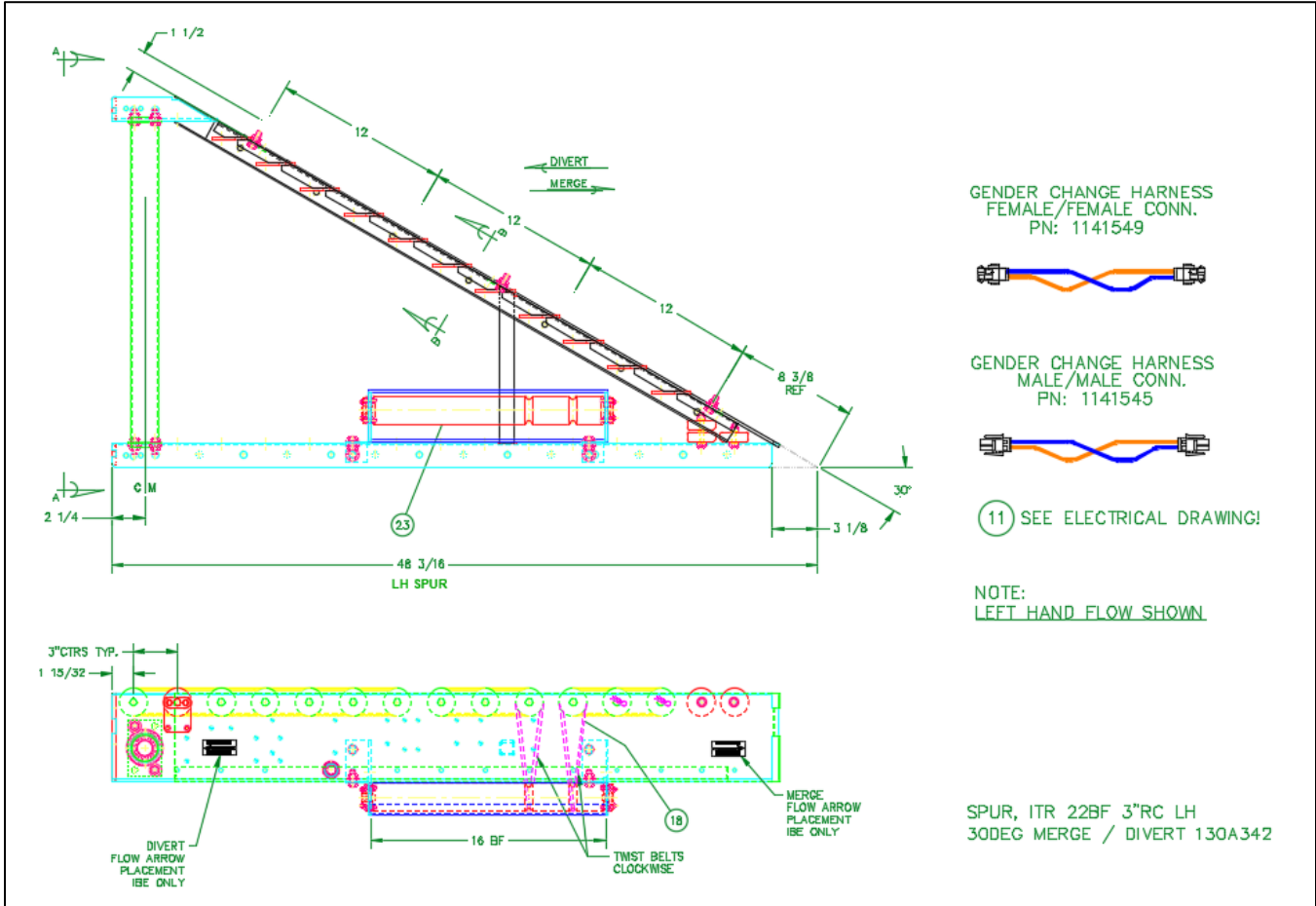

18.34.3 ITR Spur, 28BF, 3RC, 30 Degree

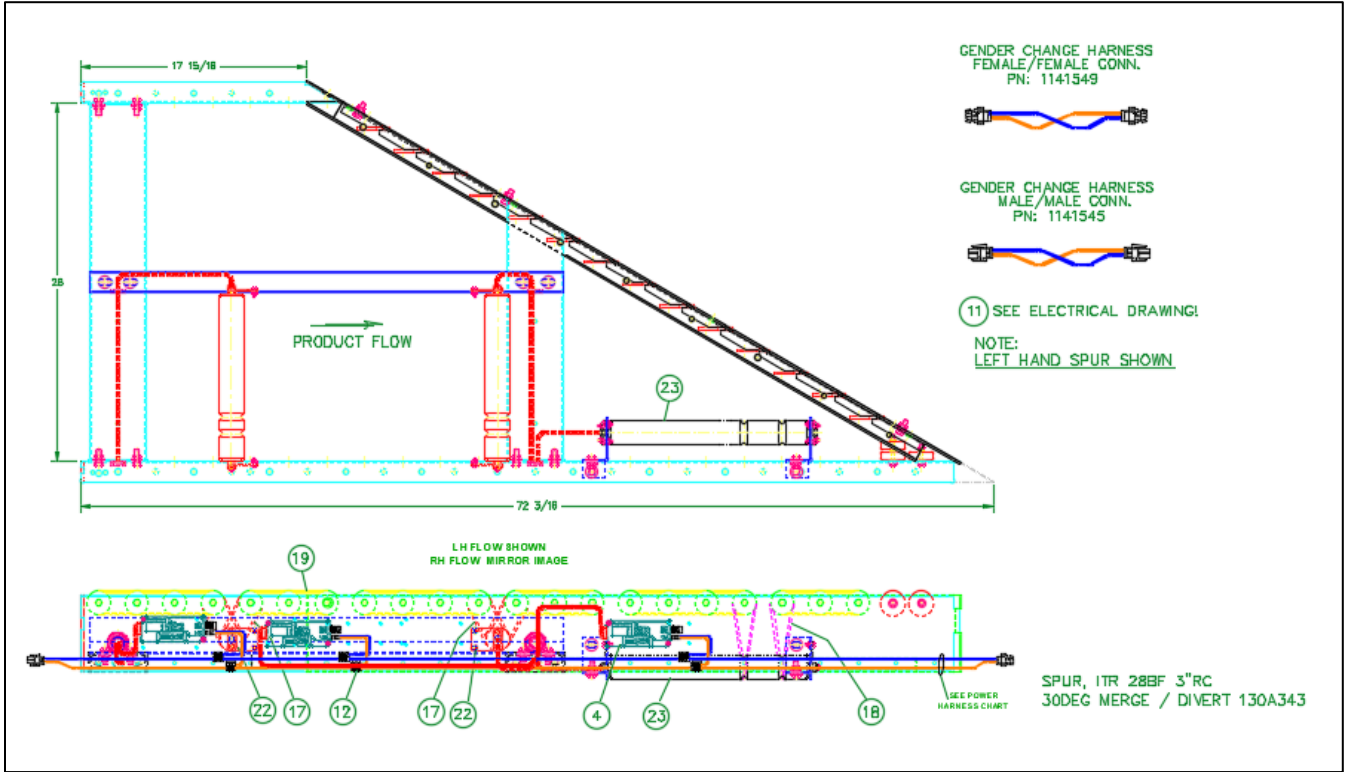

18.34.4 ITR Spur, 34BF, 3RC, 30 Degree

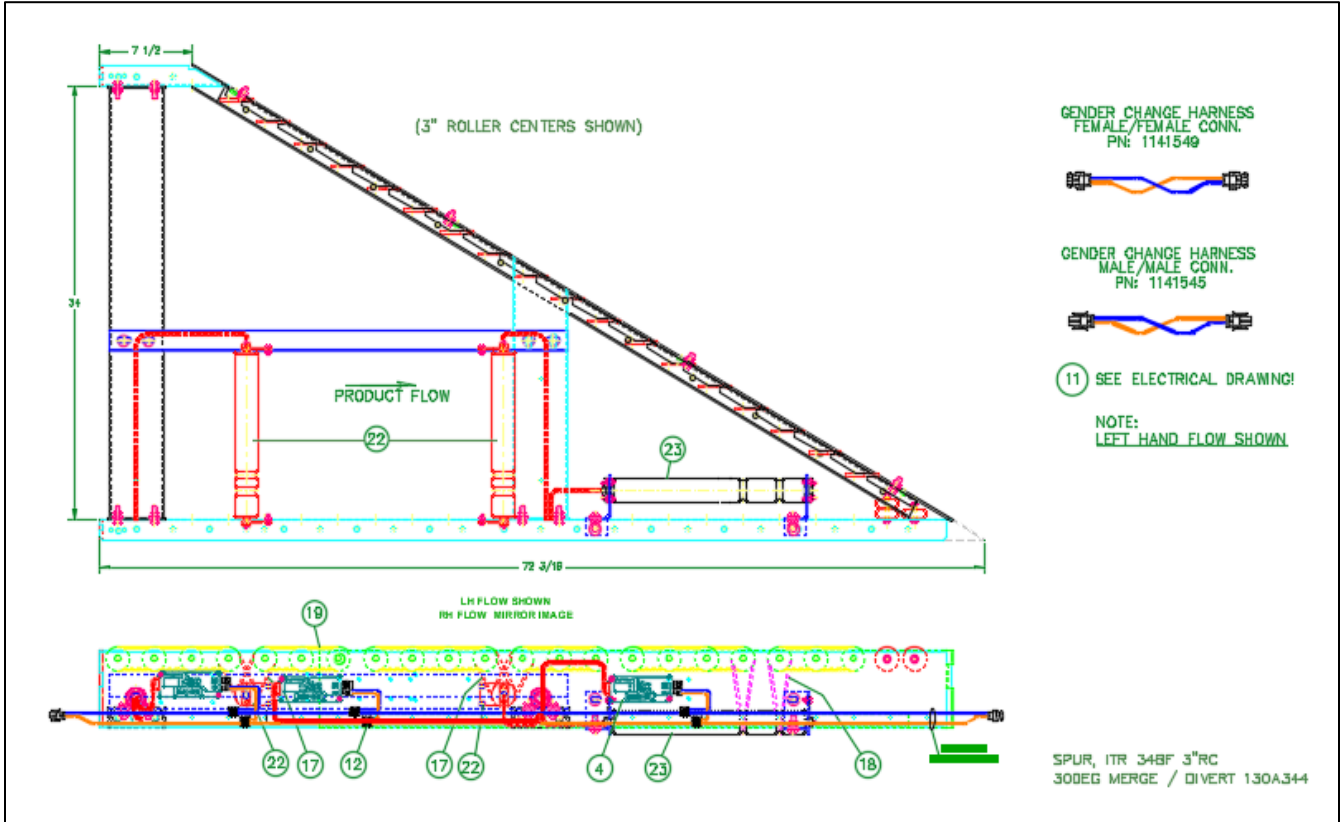

18.34.5 ITR Spur, 3RC, 30 Degree Roller Group

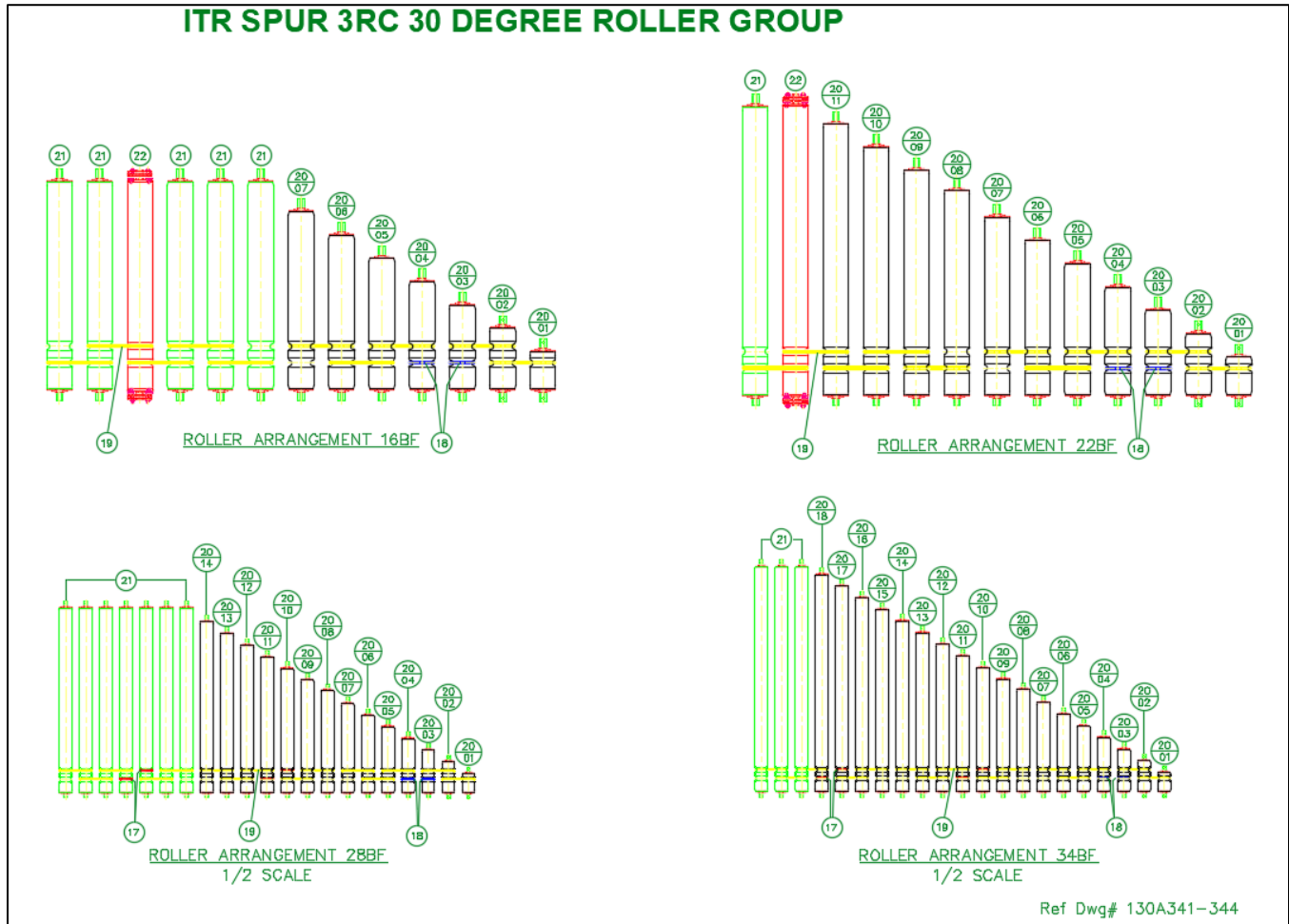

18.34.6 ITR Spur 2RC, 30 Degree Merge/Divert Roller Group

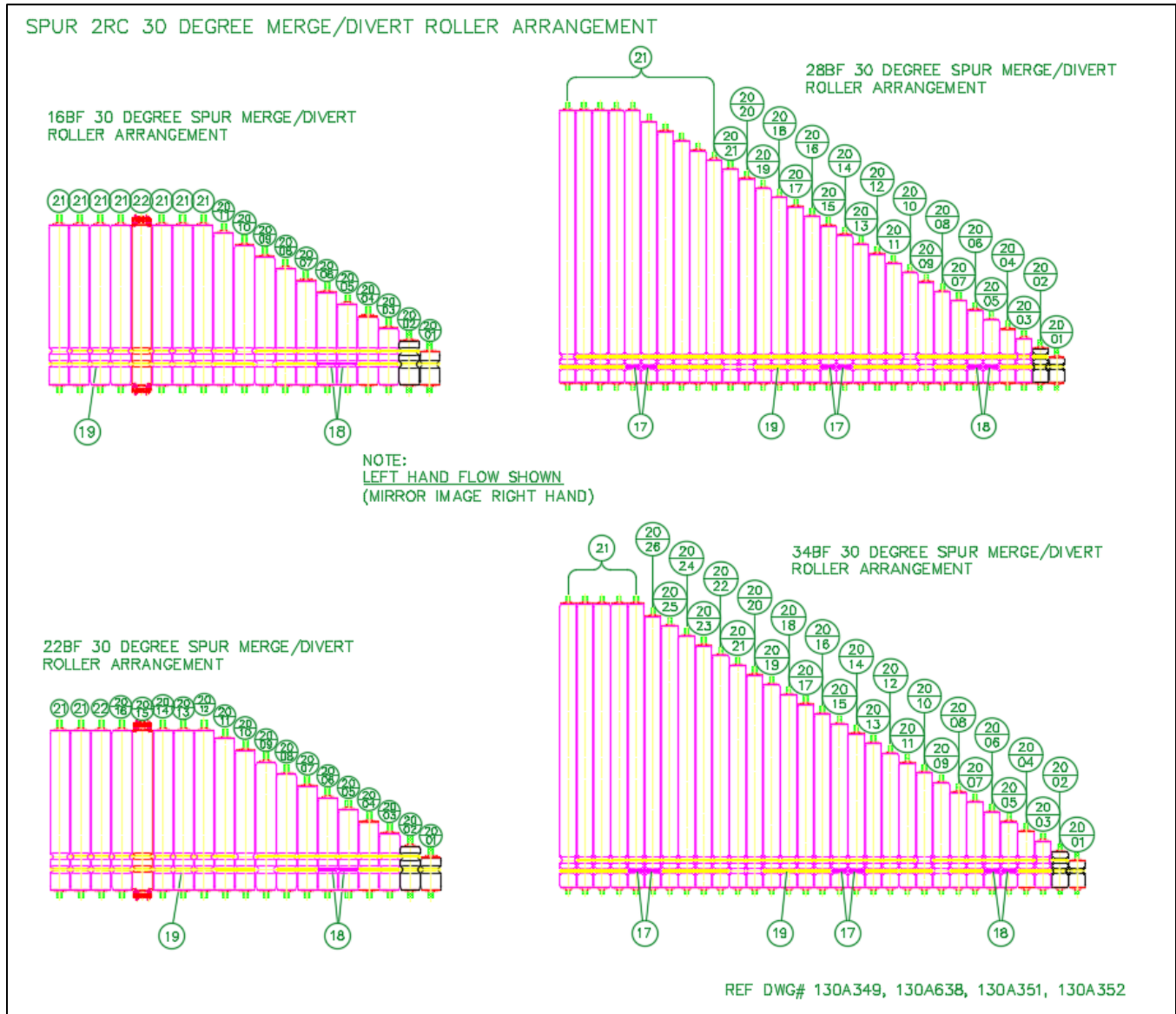

18.34.7 Replacement Parts - ITR Spur, 3RC, 30 Degree

REPLACEMENT PARTS - ITR SPUR, 3RC, 30 DEGREE					
SPUR,_ _BF-CB-C6-3RC-30D-LH/RH-FE60-_MR		Width & Item #			
Balloon	Description	16 BF	22 BF	28 BF	34 BF
---	ELECTRICAL COMPONENTS	---	---	---	---
04	DRIVERCARD, ITOH CBM-105FP	1153930	1153930	1153930	1153930
---	CONNECTOR, IDC SCOTCH LOK 558 - RED	1120174	1120174	1120174	1120174
12	CONNECTOR, IDC SCOTCHLOK 567 - BROWN	3M567	3M567	3M567	3M567
---	CONN, 3 COND, W/LEVERS 28 - 12 AWG	1102816	1102816	1102816	1102816
---	CABLE, MOTOR EXTENSION, 600, 1200, OR 2700 MM LONG	REFERENCE CABLE, MOTOR EXTENSION USED WITH STATED DRIVER CARD			
---	HARNESS, POWER BROWN & BLUE (NOT BF SPECIFIC)	3'-0" L 1102289	5'-6" L 1102288	8'-0" L 1102287	10'-6" L 1102286
---	HARNESS, ITR-POWER-10AWG 4"-FEMALE/FEMALE CONN	1141549	1141549	1141549	1141549
---	SPUR, O-RINGS	---	---	---	---
18	ORING, 3/16" DIA X 15.312" HT BLUE FOR ITR 6.5" CTRS (20% STRETCH)	1167247	1167247	1167247	1167247
17 & 19	ORING, 3/16 DIA X 9.5" HT BLUE ITR 3"CTR	E0005536	E0005536	E0005536	E0005536
---	ROLLER SET-3RC-30D-SPUR	---	---	---	---
20/01	ROLLER, ITR 3-3/8"BF PRBG NO AXLE	1143249	1143249	1143249	1143249
20/02	ROLLER, ITR 5-1/8"BF PRBG NO AXLE	1130836	1130836	1130836	1130836
20/03	ROLLER, 6-27/32BF ITR 1.9 PLTD PRBG	1131620	1131620	1131620	1131620
20/04	ROLLER, 8-9/16BF ITR 1.9 PLTD PRBG	1131621	1131621	1131621	1131621
20/05	ROLLER, 10-5/16BF ITR 1.9 PLTD PRBG	1143250	1143250	1143250	1143250
20/06	ROLLER, 12-1/32BF ITR 1.9 PLTD PRBG	1131622	1131622	1131622	1131622
20/07	ROLLER, 13-25/32BF ITR 1.9 PLTD PRBG	1131623	1131623	1131623	1131623
20/08	ROLLER, 15-1/2BF ITR 1.9 PLTD PRBG	---	1131624	1131624	1131624
20/09	ROLLER, 17-1/4BF ITR 1.9 PLTD PRBG	---	1143251	1143251	1143251
20/10	ROLLER, 18-31/32BF ITR 1.9 PLTD PRBG	---	1131625	1131625	1131625
20/11	ROLLER, 20-11/16BF ITR 1.9 PLTD PRBG	---	1143252	1143252	1143252
20/12	ROLLER, 22-7/16BF ITR 1.9 PLTD PRBG	---	---	1131627	1131627
20/13	ROLLER, 24-5/32BF ITR 1.9 PLTD PRBG	---	---	1131628	1131628
20/14	ROLLER, 25-29/32BF ITR 1.9 PLTD PRBG	---	---	1131629	1131629
20/15	ROLLER, 27-5/8BF ITR 1.9 PLTD PRBG	---	---	---	1140043
20/16	ROLLER, 29-3/8BF ITR 1.9 PLTD PRBG	---	---	---	1140044
20/17	ROLLER, 31-3/32BF ITR 1.9 PLTD PRBG	---	---	---	1140045
20/18	ROLLER, 32-13/16BF ITR 1.9 PLTD PRBG	---	---	---	1140046
21	ROLLER, _ ITR 1.9 PLTD PRBG (_ BF)	E0002412	E0002413	E0002414	E0006220
22	ROLLER, ITR _ BF 2G ITOH	1138722	1139545	1139545	1139545
23	ROLLER, ITR SPUR 2G ITOH, 2C (3" GROOVE SPACING)	1126586	1126586	1126586	1126586

Reference Dwg: Roller Arrangement & 130A341-344

18.34.8 Replacement Parts - ITR Spur, 2RC, 30 Degree

REPLACEMENT PARTS - ITR SPUR, 2RC, 30 DEGREE					
SPUR,ITR-__BF-CB-C6-2RC-30D-LH/RH-FE60-__MR		Width & Item #			
Balloon	Description	16 BF	22 BF	28 BF	34 BF
----	ELECTRICAL COMPONENTS	----	----	----	----
4	DRIVERCARD,ITOH CBM-105FP	1153930	1153930	1153930	1153930
----	CONNECTOR,IDC SCOTCH LOK 558 - RED	1120174	1120174	1120174	1120174
12	CONNECTOR,IDC SCOTCHLOK 567 - BROWN	3M567	3M567	3M567	3M567
----	CONN,3 COND,W/LEVERS28 - 12 AWG	1102816	1102816	1102816	1102816
----	CABLE,MOTOR EXTENSION, 600,1200,OR 2700 MM LONG	REFERENCE CABLE, MOTOR EXTENSION USED WITH STATED DRIVER CARD			
---	HARNESS,POWER BROWN & BLUE (NOT BF SPECIFIC)	3'-0" L 1102289	5'-5" L 1102288	8'-0" L 1102287	10'-6" L 1102286
----	HARNESS,ITR-POWER-10AWG 4"-FEMALE/FEMALE CONN	1141549	1141549	1141549	1141549
---	SPUR, O-RINGS	---	---	---	---
19	ORING,3/16 DIA X 9.5" HT BLUE ITR 3"CTR	----	----	E0005536	E0005536
18	ORING,3/16" DIA X 15.312" HT BLUE FOR ITR 6.5" CTRS (20% STRETCH)	1167247	1167247	1167247	1167247
19	ORING,3/16 DIA X 7-3/4" HT BLUE ITR 2"CTR	1142656	1142656	1142656	1142656
----	ROLLER SET-2RC-30D-SPUR	----	----	----	----
20/01	ROLLER,ITR 3-11/16" BF PRBG (NO AXLE) 1 GROOVE	1152360	1152360	1152360	1152360
20/02	ROLLER,ITR 4-3/4" BF PRBG (NO AXLE)	E0003268	E0003268	E0003268	E0003268
20/03	ROLLER,6" BF ITR 1.9" DIA PLTD PRBG	1152260	1152260	1152260	1152260
20/04	ROLLER,7-1/8" BF ITR 1.9" DIA PLTD PRBG	1152261	1152261	1152261	1152261
20/05	ROLLER,8-5/19" BF ITR 1.9" DIA PLTD PRBG	1152262	1152262	1152262	1152262
20/06	ROLLER,9-7/16" BF ITR 1.9" DIA PLTD PRBG	1152263	1152263	1152263	1152263
20/07	ROLLER,10-5/8" BF ITR 1.9" DIA PLTD PRBG	1152264	1152264	1152264	1152264
20/08	ROLLER,11-3/4" BF ITR 1.9" DIA PLTD PRBG	1152265	1152265	1152265	1152265
20/09	ROLLER,12-15/16" BF ITR 1.9" DIA PLTD PRBG	1152266	1152266	1152266	1152266
20/10	ROLLER,14-1/16" BF ITR 1.9" DIA PLTD PRBG	1152268	1152268	1152268	1152268
20/11	ROLLER,15-3/16" BF ITR 1.9" DIA PLTD PRBG	1152269	1152269	1152269	1152269
20/12	ROLLER,16-3/8" BF ITR 1.9" DIA PLTD PRBG	----	1155254	1155254	1155254
20/13	ROLLER,17-1/2" BF ITR 1.9" DIA PLTD PRBG	----	1133722	1133722	1133722
20/14	ROLLER,18-3/4" BF ITR 1.9" DIA PLTD PRBG	----	1154742	1154742	1154742
20/15	ROLLER,19-3/4" BF ITR 1.9" DIA PLTD PRBG	----	1144374	1144374	1144374
20/16	ROLLER,21" BF ITR 1.9" DIA PLTD PRBG	----	1133723	1133723	1133723
20/17	ROLLER,22-3/16" BF ITR 1.9" DIA PLTD PRBG	----	----	1155255	1155255
20/18	ROLLER,23-1/4" BF ITR 1.9" DIA PLTD PRBG	----	----	1131992	1131992
20/19	ROLLER,24-7/16" BF ITR 1.9" DIA PLTD PRBG	----	----	1133724	1133724
20/20	ROLLER,25-5/8" BF ITR 1.9" DIA PLTD PRBG	----	----	1155256	1155256
20/21	ROLLER,26-3/4" BF ITR 1.9" DIA PLTD PRBG	----	----	1154745	1154745
20/22	ROLLER,27-15/16" BF ITR 1.9" DIA PLTD PRBG	----	----	----	1133726
20/23	ROLLER,29-1/16" BF ITR 1.9" DIA PLTD PRBG	----	----	----	1133527
20/24	ROLLER,30-1/4" BF ITR 1.9" DIA PLTD PRBG	----	----	----	1155258
20/25	ROLLER,31-3/8" BF ITR 1.9" DIA PLTD PRBG	----	----	----	1133728
20/26	ROLLER,32-1/2" BF ITR 1.9" DIA PLTD PRBG	----	----	----	1155259
21	ROLLER,__ ITR 1.9" DIA PLTD (__BF)	E0002412	E0002413	E0002414	E0006220
22	ROLLER,ITR __BF 2G ITOH	1138722	1139545	1139545	1139545
23	ROLLER,ITR SPUR 2G ITOH,2C (2"GROOVE SPACING)	1152362	1152362	1152362	1152362

Reference Dwg: Roller Arrangement & 130A341-344

18.34.9 Replacement Parts - ITR Spur, IB-E03, 3RC, 30 Degree, Merge

REPLACEMENT PARTS - ITR SPUR, IB-E, 3RC, 30 DEGREE, MERGE					
SPUR, ITR-__BF-IBE-C6-3RC-30D-MERGE-LH/RH-FE60		Width & Item #			
Balloon	Description	16 BF	22 BF	28 BF	34 BF
---	ELECTRICAL COMPONENTS	---	---	---	---
---	DRIVERCARD, ITOH IB-E03BP	1166286	1166286	1166286	1166286
12	CONNECTOR, IDC SCOTCHLOK 567 - BROWN	3M567	3M567	3M567	3M567
---	CONN, WAGO 231-302/026-000 (USED W/IBE)	1162204	1162204	1162204	1162204
---	CABLE, CTRLS-CAT5E-_-GRAY	REFERENCE Cat5E COMMUNICATION CABLE			
---	CABLE, MOTOR EXTENSION, 600, 1200, OR 2700 MM LONG	REFERENCE CABLE, MOTOR EXTENSION USED WITH STATED DRIVER CARD			
---	HARNESS, POWER BROWN & BLUE (NOT BF SPECIFIC)	3'-0" L 1102289	5'-5" L 1102288	8'-0" L 1102287	10'-6" L 1102286
---	SPUR, O-RINGS	---	---	---	---
18	ORING, 3/16" DIA X 15.312" HT BLUE FOR ITR 6.5" CTRS (20% STRETCH)	1167247	1167247	1167247	1167247
19	ORING, 3/16 DIA X 9.5" HT BLUE ITR 3"CTR	E0005536	E0005536	E0005536	E0005536
---	ROLLER SET-3RC-30D-SPUR	---	---	---	---
20/1	ROLLER, ITR 3-3/8"BF PRBG NO AXLE	1143249	1143249	1143249	1143249
20/2	ROLLER, ITR 5-1/8"BF PRBG NO AXLE	1130836	1130836	1130836	1130836
20/3	ROLLER, 6-27/32BF ITR 1.9PLTD, PRBG	1131620	1131620	1131620	1131620
20/4	ROLLER, 8-9/16BF ITR 1.9PLTD, PRBG	1131621	1131621	1131621	1131621
20/5	ROLLER, 10-5/16BF ITR 1.9PLTD, PRBG	1143250	1143250	1143250	1143250
20/6	ROLLER, 12-1/32BF ITR 1.9PLTD, PRBG	1131622	1131622	1131622	1131622
20/7	ROLLER, 13-25/32BF ITR 1.9PLTD, PRBG	1131623	1131623	1131623	1131623
20/8	ROLLER, 15-1/2BF ITR 1.9PLTD, PRBG	---	1131624	1131624	1131624
20/9	ROLLER, 17-1/4BF ITR 1.9PLTD, PRBG	---	1143251	1143251	1143251
20/10	ROLLER, 18-31/32BF ITR 1.9PLTD, PRBG	---	1131625	1131625	1131625
20/11	ROLLER, 20-11/16BF ITR 1.9PLTD, PRBG	---	1143252	1143252	1143252
20/12	ROLLER, 22-7/16BF ITR 1.9PLTD, PRBG	---	---	1131627	1131627
20/13	ROLLER, 24-5/32BF ITR 1.9PLTD, PRBG	---	---	1131628	1131628
20/14	ROLLER, 25-29/32BF ITR 1.9PLTD, PRBG	---	---	1131629	1131629
20/15	ROLLER, 27-5/8BF ITR 1.9PLTD, PRBG	---	---	---	1140043
20/16	ROLLER, 29-3/8BF ITR 1.9PLTD, PRBG	---	---	---	1140044
20/17	ROLLER, 31-3/32BF ITR 1.9PLTD, PRBG	---	---	---	1140045
20/18	ROLLER, 32-13/16BF ITR 1.9PLTD, PRBG	---	---	---	1140046
21	ROLLER, __ITR 1.9" DIA PLTD (_BF)	E0002412	E0002413	E0002414	E0006220
22	ROLLER, ITR 13.25BF 2G ITOH PM486FE-60 (USED W/IBE)	1165293	1165293	1165293	1165293
23	ROLLER, ITR SPUR 2G ITOH PM 486 FE-60 (3" GROOVE SPACING) (USED W/ IBE)	1165292	1165292	1165292	1165292

Reference Dwg: Roller Arrangement & 130A341-344

18.34.10 Replacement Parts - ITR Spur Divert, IB-E03, 3RC, 30 Degree

REPLACEMENT PARTS - ITR SPUR DIVERT, IB-E03, 3RC, 30 DEGREE					
SPUR, ITR-__BF-IBE-C6-3RC-30D-DIVERT-LH/RH-FE60-__MR		Width & Item #			
Balloon	Description	16 BF	22 BF	28 BF	34 BF
---	ELECTRICAL COMPONENTS	---	---	---	---
04	DRIVERCARD, ITOH IB-E03BP	1166286	1166286	1166286	1166286
12	CONNECTOR, IDC SCOTCHLOK 567 - BROWN	3M567	3M567	3M567	3M567
----	CONN, WAGO 231-302/026-000	1162204	1162204	1162204	1162204
---	CABLE, CTRLS-CAT5E-_-GRAY	REFERENCE Cat5E COMMUNICATION CABLE			
---	CABLE, MOTOR EXTENSION, 600, 1200, OR 2700 MM LONG	REFERENCE CABLE, MOTOR EXTENSION USED WITH STATED DRIVER CARD			
----	HARNESS, POWER BROWN & BLUE (NOT BF SPECIFIC)	3'-0" L 1102289	5'-5" L 1102288	8'-0" L 1102287	10'-6" L 1102286
---	SPUR, O-RINGS	---	---	---	---
17 & 19	ORING, 3/16 DIA X 9.5" HT BLUE ITR 3"CTR	E0005536	E0005536	E0005536	E0005536
18	ORING, 3/16" DIA X 15.312" HT BLUE FOR ITR 6.5" CTRS (20% STRETCH)	1167247	1167247	1167247	1167247
---	ROLLER SET-3RC-30D-SPUR	---	---	---	---
20/01	ROLLER, ITR 3-3/8" BF PRBG NO AXLE	1143249	1143249	1143249	1143249
20/02	ROLLER, ITR 5-1/8" BF PRBG NO AXLE	1130836	1130836	1130836	1130836
20/03	ROLLER, 6-27/32BF ITR 1.9 PLTD PRBG	1131620	1131620	1131620	1131620
20/04	ROLLER, 8-9/16BF ITR 1.9 PLTD PRBG	1131621	1131621	1131621	1131621
20/05	ROLLER, 10-5/16BF ITR 1.9 PLTD PRBG	1143250	1143250	1143250	1143250
20/06	ROLLER, 12-1/32BF ITR 1.9 PLTD PRBG	1131622	1131622	1131622	1131622
20/07	ROLLER, 13-25/32BF ITR 1.9 PLTD PRBG	1131623	1131623	1131623	1131623
20/08	ROLLER, 15-1/2BF ITR 1.9 PLTD PRBG	----	1131624	1131624	1131624
20/09	ROLLER, 17-1/4BF ITR 1.9 PLTD PRBG	----	1143251	1143251	1143251
20/10	ROLLER, 18-31/32BF ITR 1.9 PLTD PRBG	----	1131625	1131625	1131625
20/11	ROLLER, 20-11/16BF ITR 1.9 PLTD PRBG	----	1143252	1143252	1143252
20/12	ROLLER, 22-7/16BF ITR 1.9 PLTD PRBG	----	----	1131627	1131627
20/13	ROLLER, 24-5/32BF ITR 1.9 PLTD PRBG	----	----	1131628	1131628
20/14	ROLLER, 25-29/32BF ITR 1.9 PLTD PRBG	----	----	1131629	1131629
20/15	ROLLER, 27-5/8BF ITR 1.9 PLTD PRBG	----	----	----	1140043
20/16	ROLLER, 29-3/8BF ITR 1.9 PLTD PRBG	----	----	----	1140044
20/17	ROLLER, 31-3/32BF ITR 1.9 PLTD PRBG	----	----	----	1140045
20/18	ROLLER, 32-13/16BF ITR 1.9 PLTD PRBG	----	----	----	1140046
21	ROLLER, __ ITR 1.9" DIA PLTD (_)	E0002412	E0002413	E0002414	E0006220
22	ROLLER, ITR 16BF 2G ITOH PM486FE-60	1163471	----	----	----
22	ROLLER, ITR 13.25BF 2G ITOH PM486FE-60	----	1165293	1165293	1165293
23	ROLLER, ITR SPUR 2G ITOH PM 486 FE-60 (3" GROOVE SPACING)	1165292	1165292	1165292	1165292

Reference Dwg: Roller Arrangement & 130A341-344

18.34.11 Replacement Parts - ITR Spur Divert, IB-E03, 2RC, 30 Degree

REPLACEMENT PARTS - ITR SPUR, DIVERT, IB-E, 2RC, 30 DEGREE					
SPUR, ITR, _BF-CB-C6-2RC-30D-LH/RH-FE60-_MR		Width & Item #			
Balloon	Description	16 BF	22 BF	28 BF	34 BF
---	ELECTRICAL COMPONENTS	---	---	---	---
--	DRIVERCARD, ITOH IB-E03BP	1166286	1166286	1166286	1166286
---	CONN, WAGO 231-302/026-000	1162204	1162204	1162204	1162204
--	CONNECTOR, IDC SCOTCHLOK 567 - BROWN	3M567	3M567	3M567	3M567
---	CABLE, MOTOR EXTENSION, 600, 1200, OR 2700 MM LONG	REFERENCE CABLE, MOTOR EXTENSION USED WITH STATED DRIVER CARD			
---	HARNESS, POWER BROWN & BLUE (NOT BF SPECIFIC)	3'-0" L 1102289	5'-5" L 1102288	8'-0" L 1102287	10'-6" L 1102286
---	HARNESS, ITR-POWER-10AWG 4"-FEMALE/FEMALE CONN	1141549	1141549	1141549	1141549
---	SPUR, O-RINGS	---	---	---	---
17 & 19	ORING, 3/16 DIA X 9.5" HT BLUE ITR 3"CTR	---	E0005536	E0005536	E0005536
18	ORING, 3/16" DIA X 15.312" HT BLUE FOR ITR 6.5" CTRS (20% STRETCH)	1167247	1167247	1167247	1167247
19	ORING, 3/16 DIA X 7-3/4" HT BLUE ITR 2"CTR	1142656	1142656	1142656	1142656
---	ROLLER SET-2RC-30D-SPUR	---	---	---	---
20/1	ROLLER, ITR 3-11/16" BF PRBG (NO AXLE) 1 GROOVE	1152360	1152360	1152360	1152360
20/2	ROLLER, ITR 4-3/4" BF PRBG NO AXLE	E0003268	E0003268	E0003268	E0003268
20/3	ROLLER, 6BF ITR 1.9 PLTD PRBG	1152260	1152260	1152260	1152260
20/4	ROLLER, 7-1/8BF ITR 1.9 PLTD PRBG	1152261	1152261	1152261	1152261
20/5	ROLLER, 8-5/16BF ITR 1.9 PLTD PRBG	1152262	1152262	1152262	1152262
20/6	ROLLER, 9-7/16BF ITR 1.9 PLTD PRBG	1152263	1152263	1152263	1152263
20/7	ROLLER, 10-5/8BF ITR 1.9 PLTD PRBG	1152264	1152264	1152264	1152264
20/8	ROLLER, 11-3/4BF ITR 1.9 PLTD PRBG	1152265	1152265	1152265	1152265
20/9	ROLLER, 12-15/16BF ITR 1.9 PLTD PRBG	1152266	1152266	1152266	1152266
20/10	ROLLER, 14-1/16BF ITR 1.9 PLTD PRBG	1152268	1152268	1152268	1152268
20/11	ROLLER, 15-3/16BF ITR 1.9 PLTD PRBG	1152269	1152269	1152269	1152269
20/12	ROLLER, 16-3/8BF ITR 1.9 PLTD PRBG	---	1155254	1155254	1155254
20/13	ROLLER, ITR 17-1/2" BF 1.9 PLTD PRBG	---	1133722	1133722	1133722
20/14	ROLLER, 18-3/4BF ITR 1.9 PLTD PRBG	---	1154742	1154742	1154742
20/15	ROLLER, 19-3/4BF ITR 1.9 PLTD PRBG	---	1144374	1144374	1144374
20/16	ROLLER, ITR 21" BF 1.9 PLTD PRBG	---	1133723	1133723	1133723
20/17	ROLLER, 22-3/16BF ITR 1.9 PLTD PRBG	---	---	1155255	1155255
20/18	ROLLER, ITR 23-1/4" BF PRBG	---	---	1131992	1131992
20/19	ROLLER, ITR 24-7/16" BF PRBG 1.9 PLTD	---	---	1133724	1133724
20/20	ROLLER, 25-5/8BF ITR 1.9 PLTD PRBG	---	---	1155256	1155256
20/21	ROLLER, 26-3/4BF ITR 1.9 PLTD PRBG	---	---	1154745	1154745
20/22	ROLLER, ITR 27-15/16" BF PRBG 1.9 PLTD	---	---	---	1133726
20/23	ROLLER, 29-1/16BF ITR 1.9 PLTD PRBG	---	---	---	1155257
20/24	ROLLER, 30-1/4BF ITR 1.9 PLTD PRBG	---	---	---	1155258
20/25	ROLLER, ITR 31-3/8" BF PRBG 1.9 PLTD	---	---	---	1133728
20/26	ROLLER, 32-1/2BF ITR 1.9 PLTD PRBG	---	---	---	1155259
21	ROLLER, _ITR 1.9" DIA PLTD (_BF)	E0002412	E0002413	E0002414	E0006220
22	ROLLER, ITR _BF 2G ITOH PM486FE-60	1163471	---	---	---
22	ROLLER, ITR 13.25BF 2G ITOH PM486FE-60	---	1165293	1165293	1165293
23	ROLLER, ITR SPUR 2G ITOH PM 486 FE-60 (3" GROOVE SPACING)	1171592	1171592	1171592	1171592

Reference Dwg: Roller Arrangement & 130A341-344

18.34.12 Replacement Parts - ITR Spur Divert (High Speed), CB-016 or IB-E, 3RC

REPLACEMENT PARTS - ITR SPUR DIVERT (HIGH SPEED), 3RC, 30 DEGREE					
SPUR, ITR-__BF-CB016 OR IBE-C6-3RC-30D-DIVERT-LH/RH-FE140		Width & Item #			
Balloon	Description	16 BF	22 BF	28 BF	34 BF
---	ELECTRICAL COMPONENTS	---	---	---	---
---	DRIVERCARD, ITOH CB-016P7	1116036	1116036	1116036	1116036
---	DRIVERCARD, ITOH IB-E03BP	1166286	1166286	1166286	1166286
---	CONNECTOR, IDC SCOTCH LOK 558 - RED (USED W/CB)	1120174	1120174	1120174	1120174
---	CONNECTOR, IDC SCOTCH LOK 567 - BROWN	3M567	3M567	3M567	3M567
---	CONN, 3 COND, W/LEVERS 28 - 12 AWG (USED W/CB)	1102816	1102816	1102816	1102816
---	CONN, WAGO 231-302/026-000 (USED W/IBE)	1162204	1162204	1162204	1162204
---	CABLE, MOTOR EXTENSION, 600, 1200, OR 2700 MM LONG	REFERENCE CABLE, MOTOR EXTENSION USED WITH STATED DRIVER CARD			
---	CABLE, CTRLS-CAT5E-_-GRAY	REFERENCE Cat5E COMMUNICATION CABLE			
---	CABLE, POWER CB-016/HB-510 14GA ITR (USED W/CB)	1139543	1139543	1139543	1139543
---	HARNESS, POWER BROWN & BLUE (NOT BF SPECIFIC)	3'-0" L 1102289	5'-5" L 1102288	8'-0" L 1102287	10'-6" L 1102286
---	HARNESS, ITR-POWER-10AWG _ _L-MALE-PIGTAIL (NOT BF SPECIFIC)	3' L 1145664	4' L 1146344	7' L 1145663	10' L 1143291
---	SPUR, O-RINGS	---	---	---	---
18	ORING, 3/16" DIA X 15.312" HT BLUE FOR ITR 6.5" CTRS (20% STRETCH)	1167247	1167247	1167247	1167247
17 & 19	ORING, 3/16 DIA X 9.5" HT BLUE, ITR 3"CTR	E0005536	E0005536	E0005536	E0005536
---	ROLLER SET ITR-30D-3RC-SPUR	---	---	---	---
20/1	ROLLER, ITR 3-3/8"BF PRBG NO AXLE	1143249	1143249	1143249	1143249
20/2	ROLLER, ITR 5-1/8"BF PRBG NO AXLE	1130836	1130836	1130836	1130836
20/3	ROLLER, 6-27/32BF ITR 1.9 PLTD PRBG	1131620	1131620	1131620	1131620
20/4	ROLLER, 8-9/16BF ITR 1.9 PLTD PRBG	1131621	1131621	1131621	1131621
20/5	ROLLER, 10-5/16BF ITR 1.9 PLTD PRBG	1143250	1143250	1143250	1143250
20/6	ROLLER, 12-1/32BF ITR 1.9 PLTD PRBG	1131622	1131622	1131622	1131622
20/7	ROLLER, 13-25/32BF ITR 1.9 PLTD PRBG	1131623	1131623	1131623	1131623
20/8	ROLLER, 15-1/2BF ITR 1.9 PLTD PRBG	---	1131624	1131624	1131624
20/9	ROLLER, 17-1/4BF ITR 1.9 PLTD PRBG	---	1143251	1143251	1143251
20/10	ROLLER, 18-31/32BF ITR 1.9 PLTD PRBG	---	1131625	1131625	1131625
20/11	ROLLER, 20-11/16BF ITR 1.9 PLTD PRBG	---	1143252	1143252	1143252
20/12	ROLLER, 22-7/16BF ITR 1.9 PLTD PRBG	---	---	1131627	1131627
20/13	ROLLER, 24-5/32BF ITR 1.9 PLTD PRBG	---	---	1131628	1131628
20/14	ROLLER, 25-29/32BF ITR 1.9 PLTD PRBG	---	---	1131629	1131629
20/15	ROLLER, 27-5/8BF ITR 1.9 PLTD PRBG	---	---	---	1140043
20/16	ROLLER, 29-3/8BF ITR 1.9 PLTD PRBG	---	---	---	1140044
20/17	ROLLER, 31-3/32BF ITR 1.9 PLTD PRBG	---	---	---	1140045
20/18	ROLLER, 32-13/16BF ITR 1.9 PLTD PRBG	---	---	---	1140046
21	ROLLER, _ ITR 1.9" DIA PLTD (_ BF)	E0002412	E0002413	E0002414	E0006220
22	ROLLER, ITR _ BF 2G ITOH PM486FE-140 (USED W/CB)	1168560	1134452	1154583	1154583
23	ROLLER, ITR SPUR 2G ITOH PM486FE-140 (USED W/CB)	1134911	1134911	1134911	1134911
22	ROLLER, ITR _ BF 2G ITOH PM486FE-140 (USED W/IBE)	1196022	1167730	1167700	1167700
23	ROLLER, ITR SPUR 2G ITOH PM486FE-140 (USED W/IBE)	1167699	1167699	1167699	1167699

Reference Dwg: Roller Arrangement & 130A341-344

18.34.13 Replacement Parts - ITR Spur Divert (High Speed), CB-016 or IB-E, 2RC

REPLACEMENT PARTS - ITR SPUR DIVERT (HIGH SPEED), 2RC, 30 DEGREE					
SPUR, ITR-__BF-CB016 OR IBE-C6-2RC-30D-DIVERT-LH /RH-FE140		Width & Item #			
Balloon	Description	16 BF	22 BF	28 BF	34 BF
---	ELECTRICAL COMPONENTS	---	---	---	---
---	DRIVERCARD, ITOH CB-016P7	1116036	1116036	1116036	1116036
---	DRIVERCARD, ITOH IB-E03BP	1166286	1166286	1166286	1166286
---	CABLE, MOTOR EXTENSION, 600, 1200, OR 2700 MM LONG	REFERENCE CABLE, MOTOR EXTENSION USED WITH STATED DRIVER CARD			
---	CABLE, CTRLS-CAT5E-_-GRAY	REFERENCE Cat5E COMMUNICATION CABLE			
---	HARNESS, POWER BROWN & BLUE (NOT BF SPECIFIC)	3'-0" L 1102289	5'-5" L 1102288	8'-0" L 1102287	10'-6" L 1102286
---	CONNECTOR, IDC SCOTCH LOK 567 - BROWN	3M567	3M567	3M567	3M567
---	CONNECTOR, IDC SCOTCH LOK 558 - RED (USED W/CB)	1120174	1120174	1120174	1120174
---	CONN, 3 COND, W/LEVERS 28 - 12 AWG (USED W/CB)	1102816	1102816	1102816	1102816
---	CONN, WAGO 231-302/026-000 (USED W/IBE)	1162204	1162204	1162204	1162204
---	SPUR, O-RINGS	---	---	---	---
17 & 19	ORING, 3/16 DIA X 9.5" HT BLUE ITR 3" CTR	E0005536	E0005536	E0005536	E0005536
18	ORING, 3/16" DIA X 15.312" HT BLUE FOR ITR 6.5" CTRS (20% STRETCH)	1167247	1167247	1167247	1167247
19	ORING, 3/16 DIA X 7-3/4" HT BLUE ITR 2" CTR	1142656	1142656	1142656	1142656
---	ROLLER SET ITR SWEEP SPUR	---	---	---	---
---	ROLLER SET-2RC-30D-SPUR	---	---	---	---
20/1	ROLLER, ITR 3-11/16" BF PRBG (NO AXLE) 1 GROOVE	1152360	1152360	1152360	1152360
20/2	ROLLER, ITR 4-3/4" BF PRBG NO AXLE	E0003268	E0003268	E0003268	E0003268
20/3	ROLLER, 6BF ITR 1.9 PLTD PRBG	1152260	1152260	1152260	1152260
20/4	ROLLER, 7-1/8BF ITR 1.9 PLTD PRBG	1152261	1152261	1152261	1152261
20/5	ROLLER, 8-5/16BF ITR 1.9 PLTD PRBG	1152262	1152262	1152262	1152262
20/6	ROLLER, 9-7/16BF ITR 1.9 PLTD PRBG	1152263	1152263	1152263	1152263
20/7	ROLLER, 10-5/8BF ITR 1.9 PLTD PRBG	1152264	1152264	1152264	1152264
20/8	ROLLER, 11-3/4BF ITR 1.9 PLTD PRBG	1152265	1152265	1152265	1152265
20/9	ROLLER, 12-15/16BF ITR 1.9 PLTD PRBG	1152266	1152266	1152266	1152266
20/10	ROLLER, 14-1/16BF ITR 1.9 PLTD PRBG	1152268	1152268	1152268	1152268
20/11	ROLLER, 15-3/16BF ITR 1.9 PLTD PRBG	1152269	1152269	1152269	1152269
20/12	ROLLER, 16-3/8BF ITR 1.9 PLTD PRBG	---	1155254	1155254	1155254
20/13	ROLLER, ITR 17-1/2" BF 1.9 PLTD PRBG	---	1133722	1133722	1133722
20/14	ROLLER, 18-3/4BF ITR 1.9 PLTD PRBG	---	1154742	1154742	1154742
20/15	ROLLER, 19-3/4BF ITR 1.9 PLTD PRBG	---	1144374	1144374	1144374
20/16	ROLLER, ITR 21" BF 1.9 PLTD PRBG	---	1133723	1133723	1133723
20/17	ROLLER, 22-3/16BF ITR 1.9 PLTD PRBG	---	---	1155255	1155255
20/18	ROLLER, ITR 23-1/4" BF PRBG	---	---	1131992	1131992
20/19	ROLLER, ITR 24-7/16" BF PRBG 1.9 PLTD	---	---	1133724	1133724
20/20	ROLLER, 25-5/8BF ITR 1.9 PLTD PRBG	---	---	1155256	1155256
20/21	ROLLER, 26-3/4BF ITR 1.9 PLTD PRBG	---	---	1154745	1154745
20/22	ROLLER, ITR 27-15/16" BF PRBG 1.9 PLTD	---	---	---	1133726
20/23	ROLLER, 29-1/16BF ITR 1.9 PLTD PRBG	---	---	---	1155257
20/24	ROLLER, 30-1/4BF ITR 1.9 PLTD PRBG	---	---	---	1155258
20/25	ROLLER, ITR 31-3/8" BF PRBG 1.9 PLTD	---	---	---	1133728
20/26	ROLLER, 32-1/2BF ITR 1.9 PLTD PRBG	---	---	---	1155259
21	ROLLER, __ ITR 1.9" DIA PLTD (__ BF)	E0002412	E0002413	E0002414	E0006220
22	ROLLER, ITR __ BF 2G ITOH PM486FE-140 (USED W/CB)	1168560	1154583	1154583	1154583
23	ROLLER, ITR SPUR 2G ITOH, 2C PM486FE-140 (USED W/CB)	1155264	1155264	1155264	1155264
22	ROLLER, ITR __ BF 2G ITOH PM486FE-140 (USED W/IBE)	1196022	1167730	1167700	1167700
23	ROLLER, ITR SPUR 2G ITOH, 2C-PM486FE-140 (USED W/IBE)	1171597	1171597	1171597	1171597

Reference Dwg: Roller Arrangement & 130A341-344

18.35 ITR SPUR TRANSPORTATION 45 DEGREE

18.35.1 ITR Spur 45 Degree 16BF

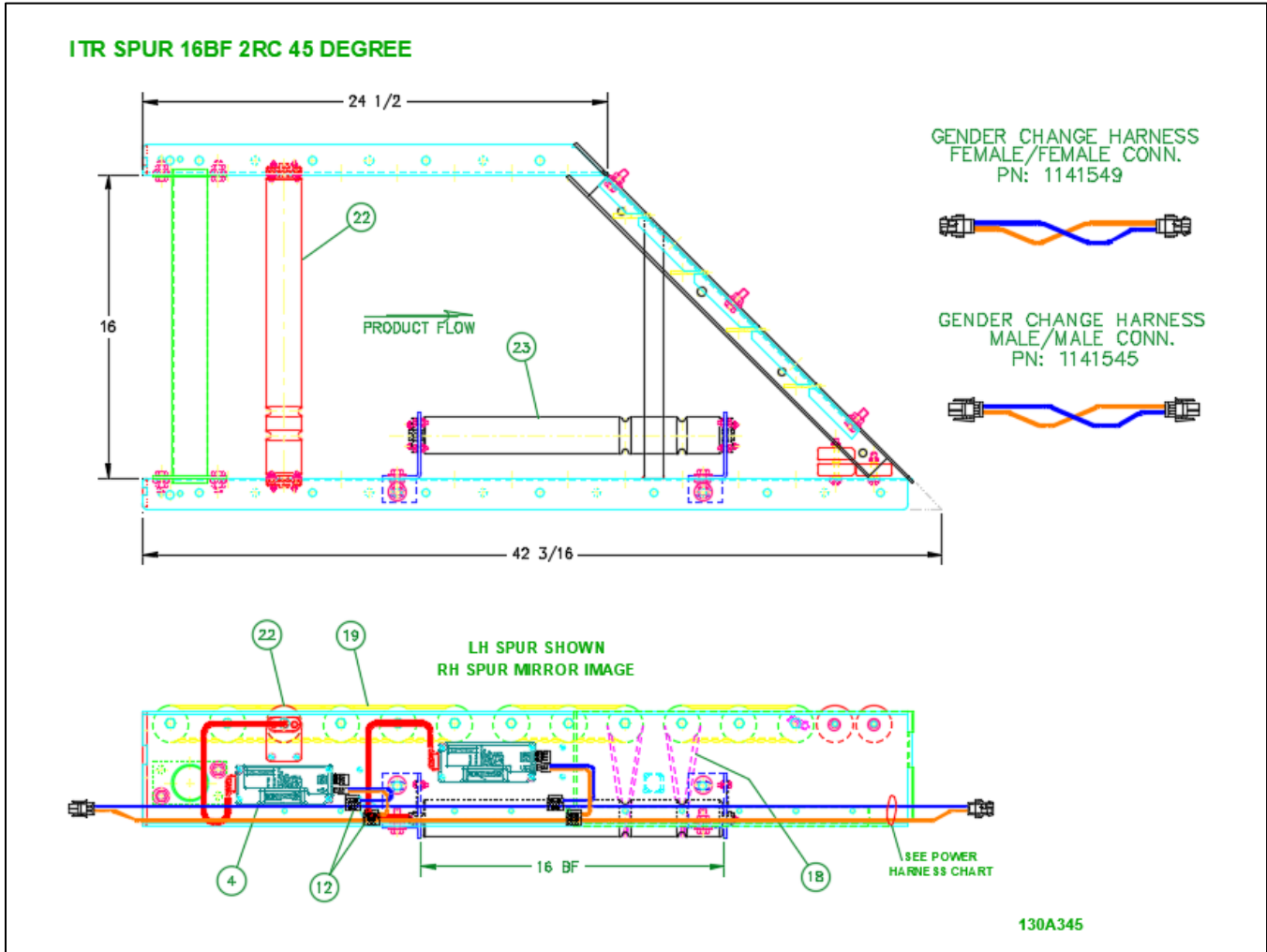

18.35.2 ITR Spur 45 Degree 22BF

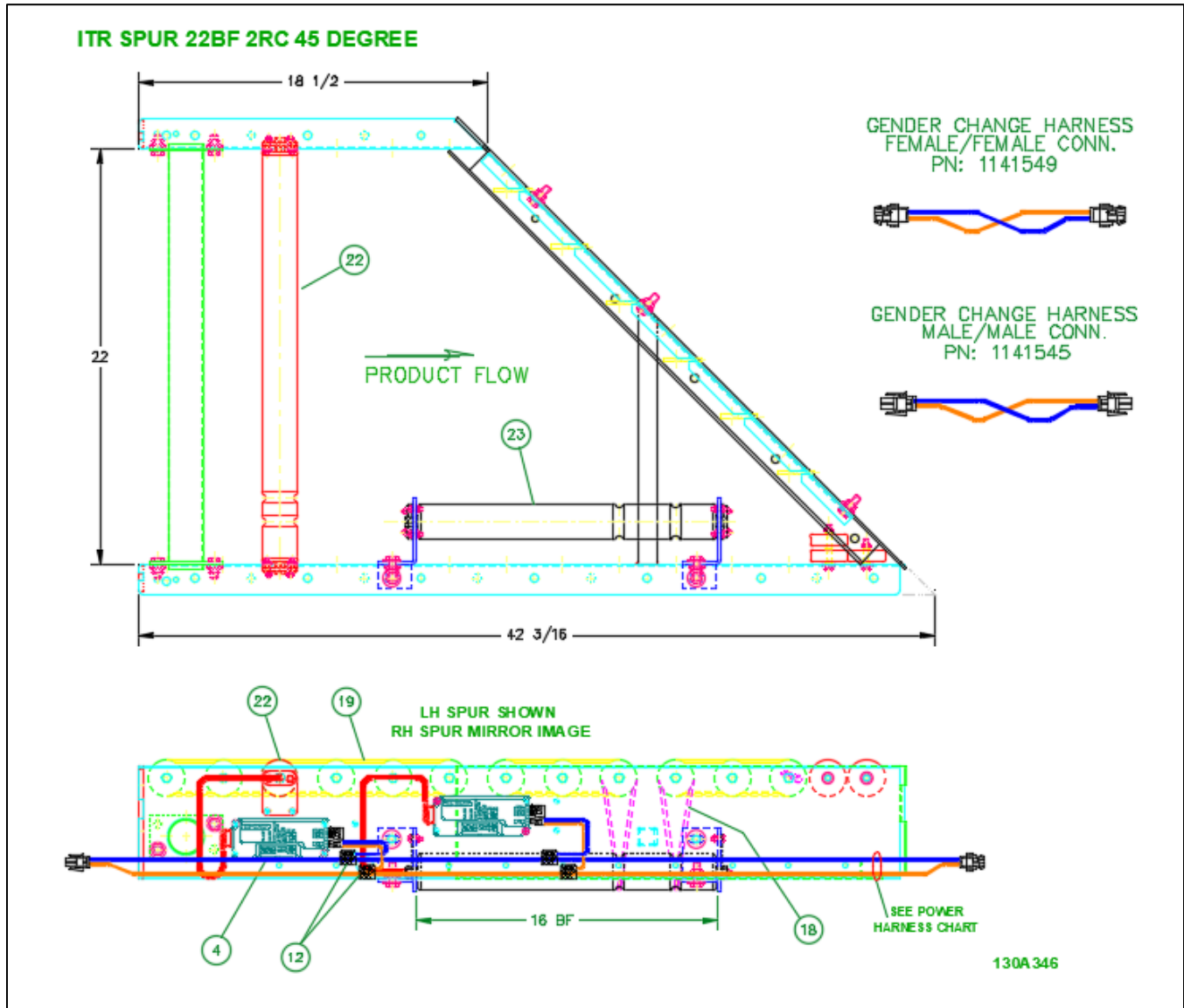

18.35.3 ITR Spur 45 Degree 28BF

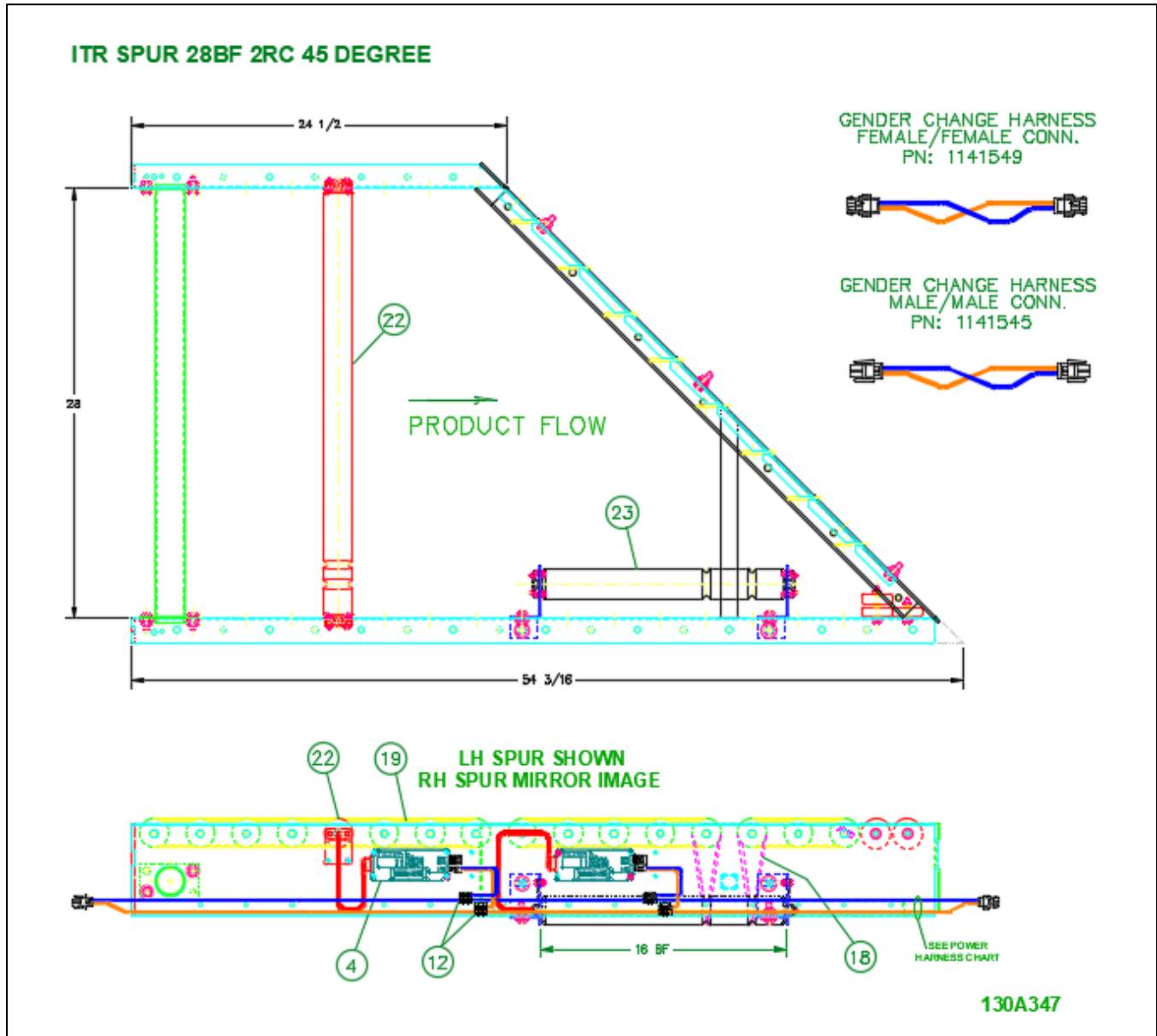

18.35.4 ITR Spur 45 Degree 34BF

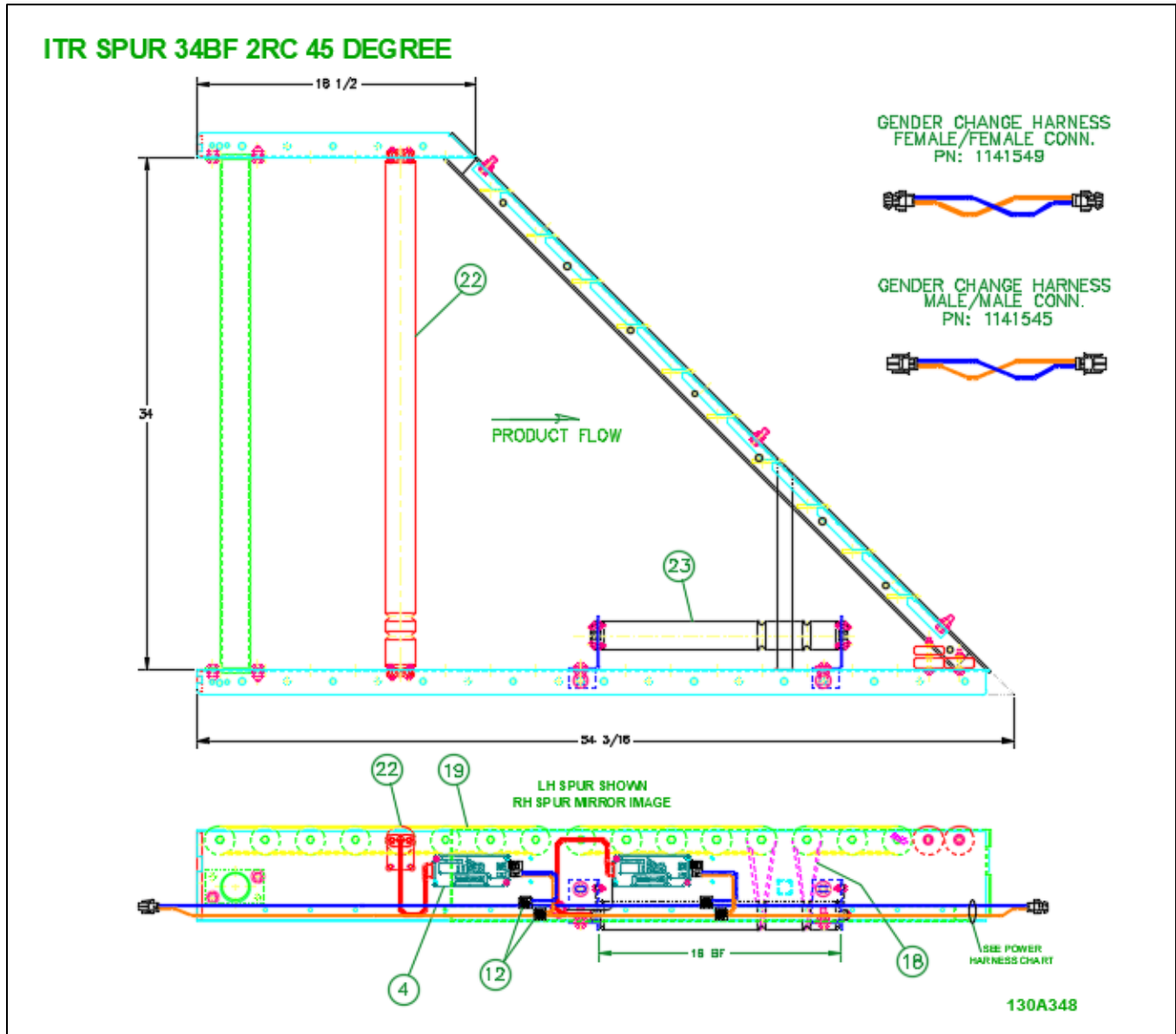

18.35.5 ITR Spur, 3RC, 45 Degree, Roller Group

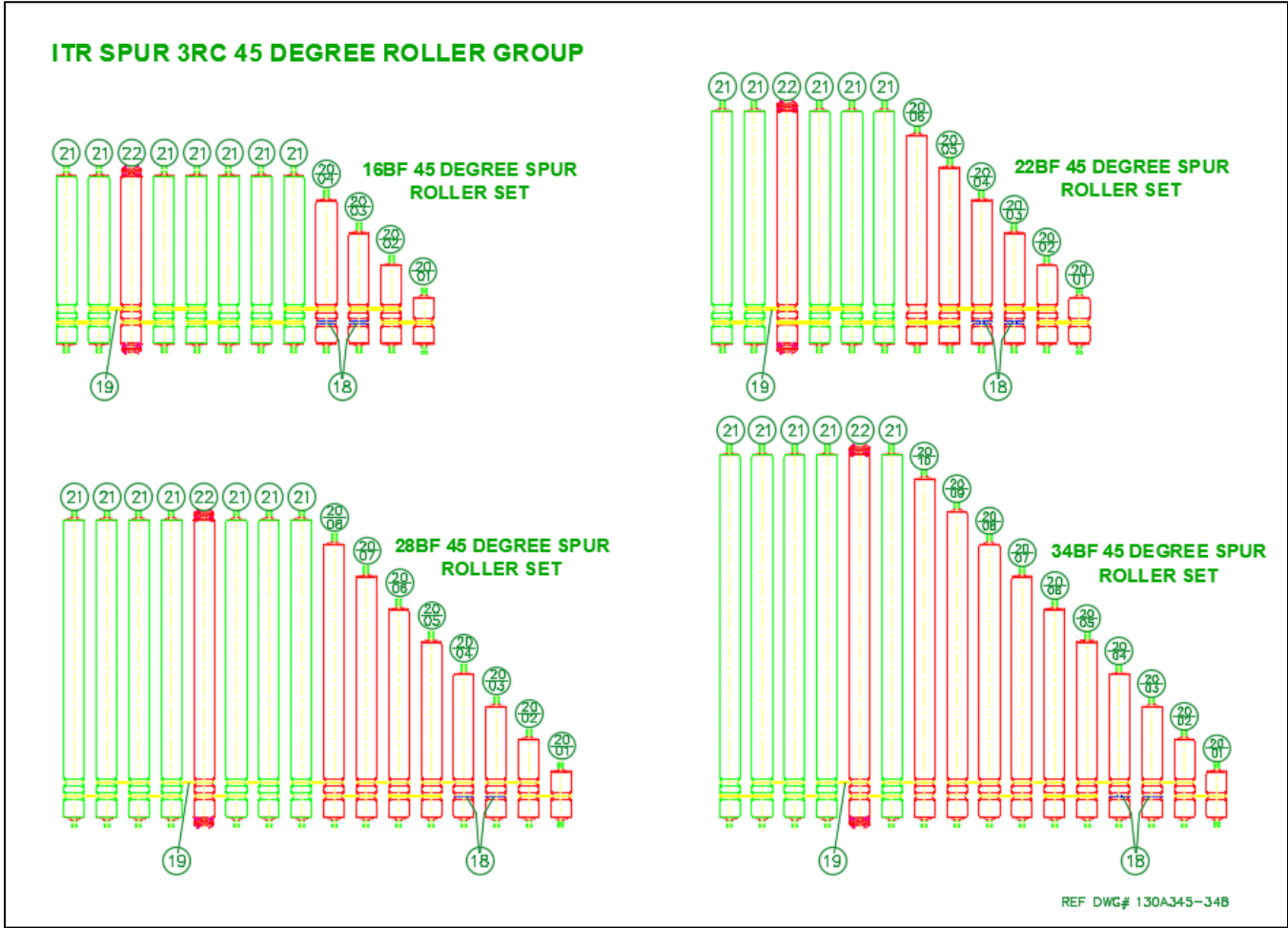

18.35.6 ITR Spur, 2RC, 45 Degree, Roller Group

ITR 2RC SPUR 45 DEGREE ROLLER GROUP

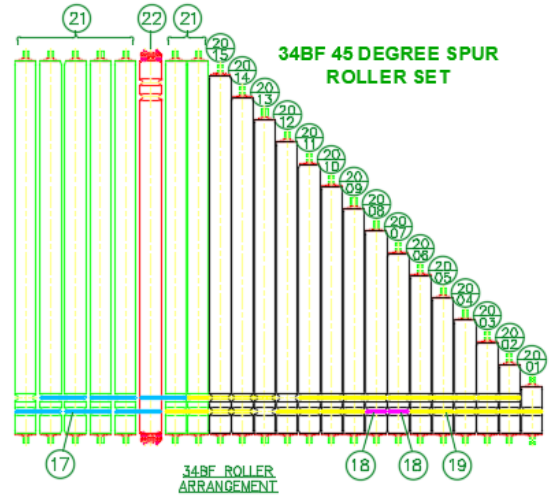
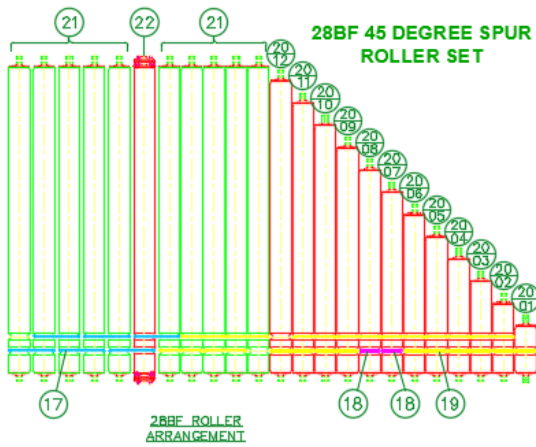
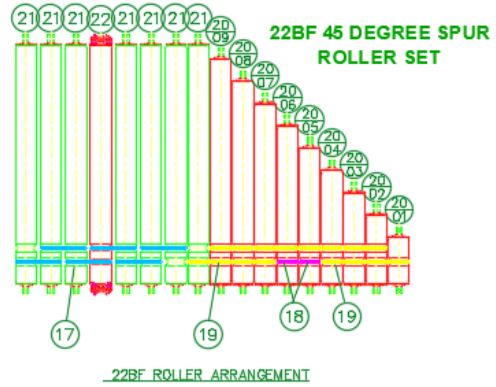
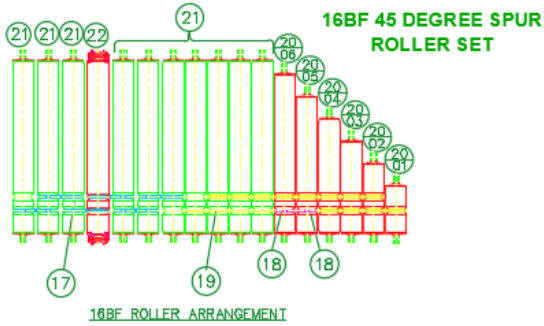

NOTE:
LEFT HAND FLOW SHOWN
(MIRROR IMAGE FOR
RIGHT HAND)

REF DWG# 130A345-348

18.35.7 Replacement Parts - ITR Spur, CBM-105, 3RC, 45 Degree

REPLACEMENT PARTS - SPUR, 3RC, 45 DEGREE					
SPUR, ITR- BF-CB-C6-3RC 45D-LH/RH-FE60		Width & Item #			
Balloon	Description	16 BF	22 BF	28 BF	34 BF
---	ELECTRICAL COMPONENTS	---	---	---	---
4	DRIVERCARD, ITOH CBM-105FP	1153930	1153930	1153930	1153930
---	CONNECTOR, IDC SCOTCH LOK 55816-22AWG RUN, 16-22AWG	1120174	1120174	1120174	1120174
12	CONNECTOR, IDC SCOTCH LOK 567 10-12AWG RUN, 14-18AWG	3M567	3M567	3M567	3M567
---	CONN, 3 COND, W/LEVERS 28 - 12 AWG	1102816	1102816	1102816	1102816
---	CABLE, MOTOR EXTENSION, 600, 1200, OR 2700 MM LONG	REFERENCE MOTOR EXTENSION CABLE TABLE			
---	HARNESS, POWER BROWN & BLUE (NOT BF SPECIFIC)	3'-0" L 1102289	5'-5" L 1102288	8'-0" L 1102287	10'-6" L 1102286
---	SPUR, O-RINGS	---	---	---	---
18	ORING, 3/16" DIA X 15.312" HT BLUE FOR ITR 6.5" CTRS (20% STRETCH)	1167247	1167247	1167247	1167247
19	ORING, 3/16 DIA X 9.5" HT BLUE ITR 3"CTR	E0005536	E0005536	E0005536	E0005536
---	ROLLER SET-3RC-45D-SPUR	---	---	---	---
20-01	ROLLER, ITR 4-3/4" BF PRBG (NO AXLE)	E0003268	E0003268	E0003268	E0003268
20-02	ROLLER, 7-3/4" BF ITR 1.9" DIA PLTD PRBG	1144370	114370	114370	1114370
20-03	ROLLER, 10-3/4" BF ITR 1.9" DIA PLTD PRBG	1144371	1144371	1144371	1144371
20-04	ROLLER, 13-3/4" BF ITR 1.9" DIA PLTD PRBG	1144372	1144372	1144372	1144372
20-05	ROLLER, 16-3/4" BF ITR 1.9" DIA PLTD PRBG	----	1144373	1144373	1144373
20-06	ROLLER, 19-3/4" BF ITR 1.9" DIA PLTD PRBG	----	1144374	1144374	1144374
20-07	ROLLER, 22-3/4" BF ITR 1.9" DIA PLTD PRBG	----	----	1144375	1144375
20-08	ROLLER, 25-3/4" BF ITR 1.9" DIA PLTD PRBG	----	----	1144376	1144376
20-09	ROLLER, 28-3/4" BF ITR 1.9" DIA PLTD PRBG	----	----	----	1144377
20-10	ROLLER, 31-3/4" BF ITR 1.9" DIA PLTD PRBG	----	----	----	1144378
21	ROLLER, ITR 1.9" DIA PLTD (BF)	E0002412	E0002413	E0002414	E0006220
22	ROLLER, ITR BF 2G ITOH FE-60	1138722	1138723	1138724	1138725
23	ROLLER, ITR SPUR 2G ITOH PM 486 FE-60	1126586	1126586	1126586	1126586

Reference Dwg: Roller Arrangement & 130A345-348

18.35.8 Replacement Parts - ITR Spur, CBM-105, 2RC, 45 Degree

REPLACEMENT PARTS - SPUR, 2RC, 45 DEGREE					
SPUR, ITR-__BF-CB-C6-2RC 45D-LH/RH-FE60		Width & Item #			
Balloon	Description	16 BF	22 BF	28 BF	34 BF
---	ELECTRICAL COMPONENTS	---	---	---	---
04	DRIVERCARD, ITOH CBM-105FP	1153930	1153930	1153930	1153930
---	CONNECTOR, IDC SCOTCH LOK 55816-22AWG RUN, 16-22AWG	1120174	1120174	1120174	1120174
12	CONNECTOR, IDC SCOTCH LOK 567 10-12AWG RUN, 14-18AWG	3M567	3M567	3M567	3M567
---	CONN, 3 COND, W/LEVERS 28 - 12 AWG	1102816	1102816	1102816	1102816
---	CABLE, MOTOR EXTENSION, 600, 1200, OR 2700 MM LONG	REFERENCE MOTOR EXTENSION CABLE TABLE			
---	HARNESS, POWER BROWN & BLUE (NOT BF SPECIFIC)	3'-0" L 1102289	5'-5" L 1102288	8'-0" L 1102287	10'-6" L 1102286
---	SPUR, O-RINGS	---	---	---	---
17	ORING, 3/16" DIA X 8-1/4" HT BLUE	E0034023	E0034023	E0034023	E0034023
18	ORING, 3/16" DIA X 15.312" HT BLUE FOR ITR 6.5" CTRS (20% STRETCH)	1167247	1167247	1167247	1167247
19	ORING, 3/16 DIA X 7-3/4" HT BLUE ITR 2" CTR	1142656	1142656	1142656	1142656
---	ROLLER SET-2RC-45D-SPUR	---	---	---	---
20-01	ROLLER, ITR 4-3/4" BF PRBG (NO AXLE)	E0003268	E0003268	E0003268	E0003268
20-02	ROLLER, 6-3/4" BF ITR 1.9" DIA PLTD PRBG	1154738	1154738	1154738	1154738
20-03	ROLLER, 8-3/4" BF ITR 1.9" DIA PLTD PRBG	1154739	1154739	1154739	1154739
20-04	ROLLER, 10-3/4" BF ITR 1.9" DIA PLTD PRBG	1144371	1144371	1144371	1144371
20-05	ROLLER, 12-3/4" BF ITR 1.9" DIA PLTD PRBG	1154740	1154740	1154740	1154740
20-06	ROLLER, 14-3/4" BF ITR 1.9" DIA PLTD PRBG	1154741	1154741	1154741	1154741
20-07	ROLLER, 16-3/4" BF ITR 1.9" DIA PLTD PRBG	---	1144373	1144373	1144373
20-08	ROLLER, 18-3/4" BF ITR 1.9" DIA PLTD PRBG	---	1154742	1154742	1154742
20-09	ROLLER, 20-3/4" BF ITR 1.9" DIA PLTD PRBG	---	1154743	1154743	1154743
20-10	ROLLER, 22-3/4" BF ITR 1.9" DIA PLTD PRBG	---	---	1144375	1144375
20-11	ROLLER, 24-3/4" BF ITR 1.9" DIA PLTD PRBG	---	---	1154744	1154744
20-12	ROLLER, 26-3/4" BF ITR 1.9" DIA PLTD PRBG	---	---	1154745	1154745
20-13	ROLLER, 28-3/4BF ITR 1.9" DIA PLTD PRBG	---	---	---	1144377
20-14	ROLLER, 30-3/4BF ITR 1.9" DIA PLTD PRBG	---	---	---	1155572
20-15	ROLLER, 32-3/4BF ITR 1.9" DIA PLTD PRBG	---	---	---	1155573
21	ROLLER, __ITR 1.9" DIA PLTD (__BF)	E0002412	E0002413	E0002414	E0006220
22	ROLLER, ITR __BF 2G ITOH FE-60	1138722	1138723	1138724	1138725
23	ROLLER, ITR SPUR 2G ITOH, 2C-PM 486 FE-60	1152362	1152362	1152362	1152362

Reference Dwg: Roller Arrangement & 130A345-348

18.35.9 Replacement Parts - ITR Spur, IB-E03, 3RC, 45 Degree, Merge

REPLACEMENT PARTS - ITR SPUR, IB-E 3RC, 45 DEGREE, MERGE					
SPUR, ITR-__BF-IBE-C6-3RC-45D-MERGE-LH/RH-FE60		Width & Item #			
Balloon	Description	16 BF	22 BF	28 BF	34 BF
---	ELECTRICAL COMPONENTS	---	---	---	---
---	DRIVERCARD, ITOH IB-E03BP	1166286	1166286	1166286	1166286
12	CONNECTOR, IDC SCOTCHLOK 567 - BROWN	3M567	3M567	3M567	3M567
---	CONN, WAGO 231-302/026-000	1162204	1162204	1162204	1162204
---	CABLE, MOTOR EXTENSION, 600, 1200, OR 2700 MM LONG	REFERENCE CABLE, MOTOR EXTENSION USED WITH STATED DRIVER CARD			
---	HARNESS, POWER BROWN & BLUE (NOT BF SPECIFIC)	3'-0" L 1102289	5'-5" L 1102288	8'-0" L 1102287	10'-6" L 1102286
---	SPUR, O-RINGS	---	---	---	---
18	ORING, 3/16" DIA X 15.312" HT BLUE FOR ITR 6.5" CTRS (20% STRETCH)	1167247	1167247	1167247	1167247
19	ORING, 3/16 DIA X 9.5" HT BLUE ITR 3" CTR	E0005536	E0005536	E0005536	E0005536
---	ROLLER SET-3RC-45D-SPUR	---	---	---	---
20-01	ROLLER, ITR 4-3/4" BF PRBG (NO AXLE)	E0003268	E0003268	E0003268	E0003268
20-02	ROLLER, 7-3/4" BF ITR 1.9" DIA PLTD PRBG	1144370	114370	114370	1114370
20-03	ROLLER, 10-3/4" BF ITR 1.9" DIA PLTD PRBG	1144371	1144371	1144371	1144371
20-04	ROLLER, 13-3/4" BF ITR 1.9" DIA PLTD PRBG	1144372	1144372	1144372	1144372
20-05	ROLLER, 16-3/4" BF ITR 1.9" DIA PLTD PRBG	---	1144373	1144373	1144373
20-06	ROLLER, 19-3/4" BF ITR 1.9" DIA PLTD PRBG	---	1144374	1144374	1144374
20-07	ROLLER, 22-3/4" BF ITR 1.9" DIA PLTD PRBG	---	---	1144375	1144375
20-08	ROLLER, 25-3/4" BF ITR 1.9" DIA PLTD PRBG	---	---	1144376	1144376
20-09	ROLLER, 28-3/4" BF ITR 1.9" DIA PLTD PRBG	---	---	---	1144377
20-10	ROLLER, 31-3/4" BF ITR 1.9" DIA PLTD PRBG	---	---	---	1144378
21	ROLLER, __ ITR 1.9" DIA PLTD (__ BF)	E0002412	E0002413	E0002414	E0006220
22	ROLLER, ITR SPUR 2G ITOH, 2C, PM486 FE-60	1165292	1165292	1165292	1165292
23	ROLLER, ITR __ BF 2G ITOH PM486FE-60	1163471	1163472	1163473	1163474

Reference Dwg: Roller Arrangement & 130A345-348

18.35.10 Replacement Parts - ITR Spur, IB-E03, 2RC, 45 Degree, Merge

REPLACEMENT PARTS - ITR SPUR, IB-E, 2RC, 45 DEGREE, MERGE					
SPUR, ITR- _BF-IBE-C6-2RC-45D-MERGE-LH/RH-FE60		Width & Item #			
Balloon	Description	16 BF	22 BF	28 BF	34 BF
---	ELECTRICAL COMPONENTS	---	---	---	---
---	DRIVERCARD, ITOH IB-E03BP	1166286	1166286	1166286	1166286
12	CONNECTOR, IDC SCOTCHLOK 567 - BROWN	3M567	3M567	3M567	3M567
---	CONN, WAGO 231-302/026-000	1162204	1162204	1162204	1162204
---	CABLE, CTRLS-CAT5E- _'-GRAY	REFERENCE Cat5E COMMUNICATION CABLE			
---	CABLE, MOTOR EXTENSION, 600, 1200, OR 2700 MM LONG	REFERENCE CABLE, MOTOR EXTENSION USED WITH STATED DRIVER CARD			
---	HARNESS, POWER BROWN & BLUE (NOT BF SPECIFIC)	3'-0" L 1102289	5'-5" L 1102288	8'-0" L 1102287	10'-6" L 1102286
---	SPUR, O-RINGS	---	---	---	---
17	ORING, 3/16" DIA X 8-1/4" HT BLUE	E0034023	E0034023	E0034023	E0034023
18	ORING, 3/16" DIA X 15.312" HT BLUE FOR ITR 6.5" CTRS (20% STRETCH)	1167247	1167247	1167247	1167247
19	ORING, 3/16 DIA X 7-3/4" HT BLUE ITR 2"CTR	1142656	1142656	1142656	1142656
---	ROLLER SET-2RC-45D-SPUR	---	---	---	---
20-01	ROLLER, ITR 4-3/4" BF PRBG (NO AXLE)	E0003268	E0003268	E0003268	E0003268
20-02	ROLLER, 6-3/4" BF ITR 1.9" DIA PLTD PRBG	1154738	1154738	1154738	1154738
20-03	ROLLER, 8-3/4" BF ITR 1.9" DIA PLTD PRBG	1154739	1154739	1154739	1154739
20-04	ROLLER, 10-3/4" BF ITR 1.9" DIA PLTD PRBG	1144371	1144371	1144371	1144371
20-05	ROLLER, 12-3/4" BF ITR 1.9" DIA PLTD PRBG	1154740	1154740	1154740	1154740
20-06	ROLLER, 14-3/4" BF ITR 1.9" DIA PLTD PRBG	1154741	1154741	1154741	1154741
20-07	ROLLER, 16-3/4" BF ITR 1.9" DIA PLTD PRBG	---	1144373	1144373	1144373
20-08	ROLLER, 18-3/4" BF ITR 1.9" DIA PLTD PRBG	---	1154742	1154742	1154742
20-09	ROLLER, 20-3/4" BF ITR 1.9" DIA PLTD PRBG	---	1154743	1154743	1154743
20-10	ROLLER, 22-3/4" BF ITR 1.9" DIA PLTD PRBG	---	---	1144375	1144375
20-11	ROLLER, 24-3/4" BF ITR 1.9" DIA PLTD PRBG	---	---	1154744	1154744
20-12	ROLLER, 26-3/4" BF ITR 1.9" DIA PLTD PRBG	---	---	1154745	1154745
20-13	ROLLER, 28-3/4" BF ITR 1.9" DIA PLTD PRBG	---	---	---	1144377
20-14	ROLLER, 30-3/4" BF ITR 1.9" DIA PLTD PRBG	---	---	---	1155572
20-15	ROLLER, 32-3/4" BF ITR 1.9" DIA PLTD PRBG	---	---	---	1155573
21	ROLLER, _ ITR 1.9" DIA PLTD (_BF)	E0002412	E0002413	E0002414	E0006220
22	ROLLER, ITR _BF 2G ITOH PM486FE-60	1163471	1163472	1163473	1163474
23	ROLLER, ITR SPUR 2G ITOH, 2C, PM 486 FE-60	1171592	1171592	1171592	1171592

Reference Dwg: Roller Arrangement & 130A345-348

18.36 ITR MERGE

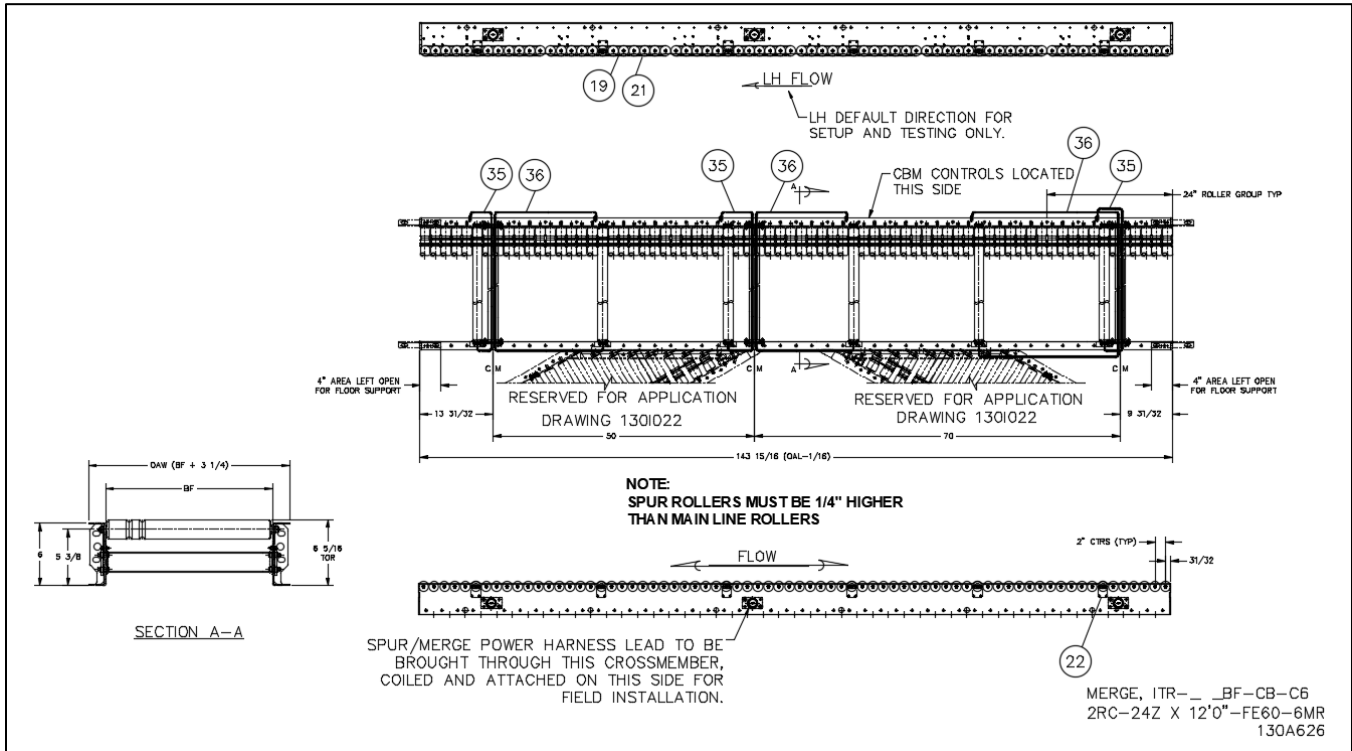

18.36.1 Replacement Parts - ITR Merge

REPLACEMENT PARTS - ITR MERGE					
MERGE, ITR-__ _BF-(CB OR IBE)-C6-2RC-24Z		Width & Item #			
Balloon	Description	16 BF	22 BF	28 BF	34 BF
1	DRIVERCARD, ITOH CBM-105FP	1153930	1153930	1153930	1153930
1	DRIVERCARD, ITOH IB-E03BP	1166286	1166286	1166286	1166286
19	ORING, 3/16 DIA X 7-3/4" HT BLUE ITR 2"CTR	1142656	1142656	1142656	1142656
21	ROLLER, __ITR 1.9PLTD PRBG	E0002412	E0002413	E0002414	E0006220
3	ROLLER, ITR __BF 2G ITOH PM486FE-60 (USED W/CBM-105)	1138722	1138723	1138724	1138725
3	ROLLER, ITR __BF 2G ITOH PM486FE-60 (USED W/IBE)	1163471	1163472	1163473	1163474
---	CABLE, CTRLS-CAT5E-_-GRAY	REFERENCE Cat5E COMMUNICATION CABLE			
35 & 36	CABLE, MOTOR EXTENSION, 600, 1200, OR 2700 MM LONG	REFERENCE CABLE, MOTOR EXTENSION USED WITH STATED DRIVER CARD			
Reference Dwg: 130A626					
Single bed that does not come with a spur bed, but is designed to have a spur mounted to it. Must use designated bracket MHS P/N: 1208351.					

18.37 ITR MERGE BRACKET KIT 30 & 45 DEGREE

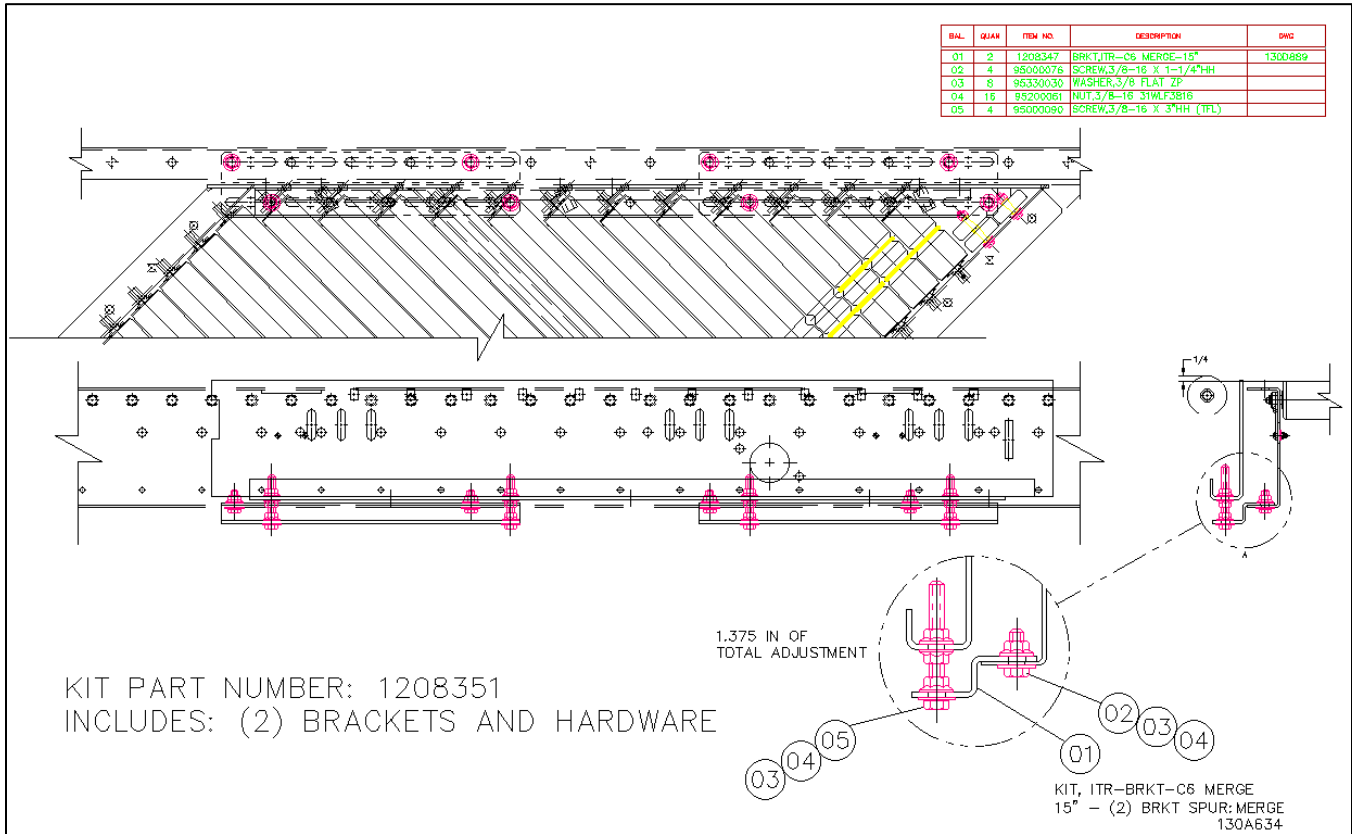

18.38 ITR POWER MERGE

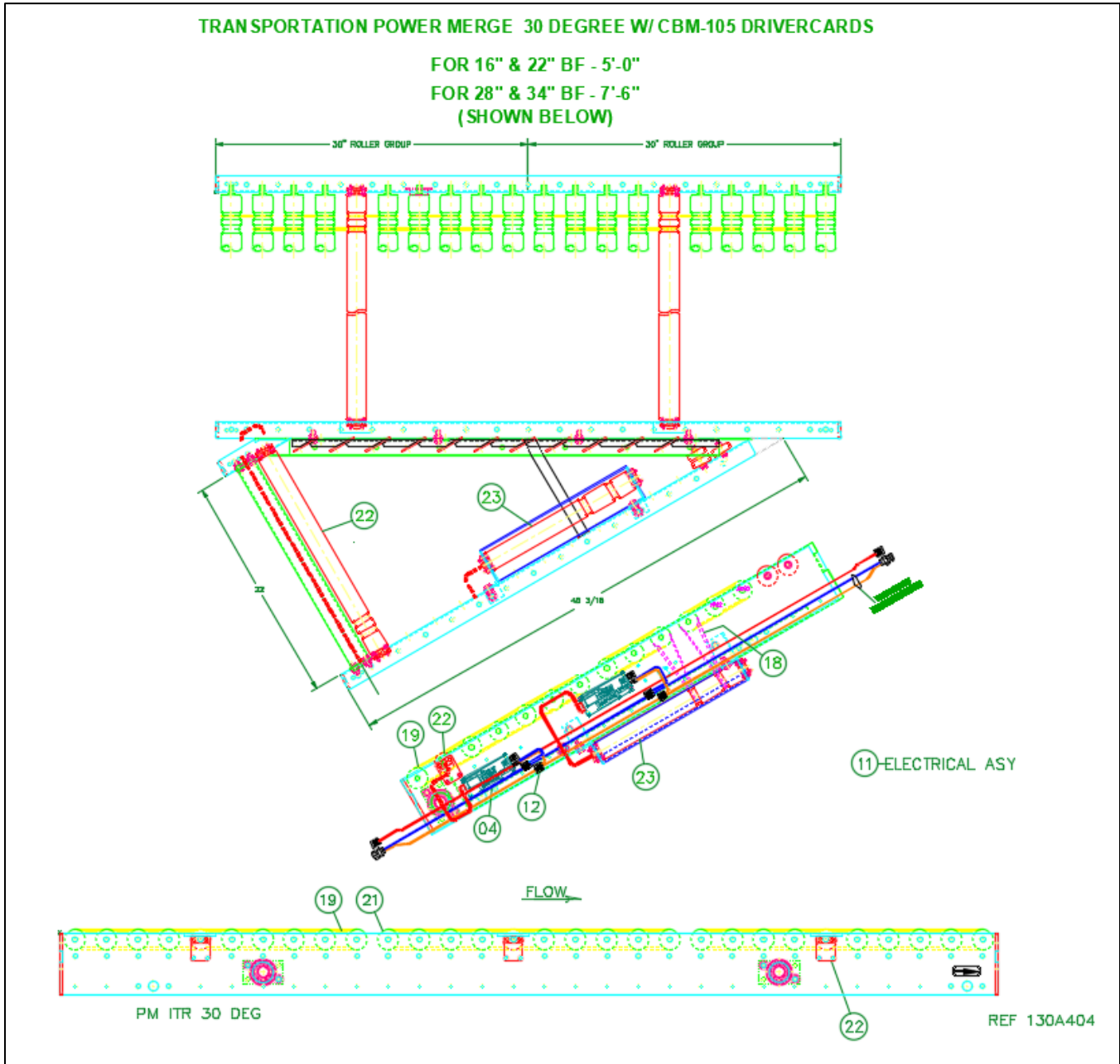

18.38.1 Replacement Parts - ITR Power Merge, 3RC, 30 Degree

REPLACEMENT PARTS - ITR POWER MERGE, 3RC, 30 DEGREE					
PM,ITR-__BF-(CB OR IBE)-C6-3RC-30D-LH/RH-FE60-_MR		Width & Item #			
Balloon	Description	16 BF	22 BF	28 BF	34 BF
---	ELECTRICAL COMPONENTS	---	---	---	---
04	DRIVERCARD,ITOH CBM-105FP	1153930	1153930	1153930	1153930
04	DRIVERCARD,ITOH IB-E03BP	1166286	1166286	1166286	1166286
----	CONN,3 COND,W/LEVERS 28 - 12 AWG (USED W/CBM)	1102816	1102816	1102816	1102816
----	CONNECTOR,IDC SCOTCH LOK 558 - RED (USED W/CBM)	1120174	1120174	1120174	1120174
----	CONNECTOR,IDC SCOTCHLOK 562 - YELLOW	3M562	3M562	3M562	3M562
12	CONNECTOR,IDC SCOTCH LOK 567 - BROWN	3M567	3M567	3M567	3M567
---	CONN, WAGO 231-302/026-000 (USED W/IBE)	1162204	1162204	1162204	1162204
---	CABLE,MOTOR EXTENSION, 600,1200,OR 2700 MM LONG	REFERENCE CABLE, MOTOR EXTENSION USED WITH STATED DRIVER CARD			
----	CABLE,POWER CB-016/HB-510 14GA ITR (USED W/CBM)	1139543	1139543	1139543	1139543
---	CABLE,CTRLS-CAT5E-_-GRAY	REFERENCE Cat5E COMMUNICATION CABLE			
--	HARNESS,POWER BROWN & BLUE (NOT BF SPECIFIC)	3'-0" L 1102289	5'-5" L 1102288	8'-0" L 1102287	10'-6" L 1102286
---	HARNESS,ITR-POWER-10AWG _ _L-MALE-PIGTAIL (NOT BF SPECIFIC)	3' L 1145664	4' L 1146344	7' L 1145663	10' L 1143291
18	ORING,3/16" DIA X 15.312" HT BLUE FOR ITR 6.5" CTRS (20% STRETCH)	1167247	1167247	1167247	1167247
17 & 19	ORING,3/16 DIA X 9.5" HT BLUE ITR 3"CTR	E0005536	E0005536	E0005536	E0005536
---	ROLLER SET ITR-30D-3RC-SPUR	---	---	---	---
20/1	ROLLER,ITR 3-3/8"BF PRBG NO AXLE	1143249	1143249	1143249	1143249
20/2	ROLLER,ITR 5-1/8"BF PRBG NO AXLE	1130836	1130836	1130836	1130836
20/3	ROLLER,6-27/32BF ITR 1.9PLTD,PRBG	1131620	1131620	1131620	1131620
20/4	ROLLER,8-9/16BF ITR 1.9PLTD,PRBG	1131621	1131621	1131621	1131621
20/5	ROLLER,10-5/16BF ITR 1.9PLTD,PRBG	1143250	1143250	1143250	1143250
20/6	ROLLER,12-1/32BF ITR 1.9PLTD,PRBG	1131622	1131622	1131622	1131622
20/7	ROLLER,13-25/32BF ITR 1.9PLTD,PRBG	1131623	1131623	1131623	1131623
20/8	ROLLER,15-1/2BF ITR 1.9PLTD,PRBG	----	1131624	1131624	1131624
20/9	ROLLER,17-1/4BF ITR 1.9PLTD,PRBG	----	1143251	1143251	1143251
20/10	ROLLER,18-31/32BF ITR 1.9PLTD,PRBG	----	1131625	1131625	1131625
20/11	ROLLER,20-11/16BF ITR 1.9PLTD,PRBG	----	1143252	1143252	1143252
20/12	ROLLER,22-7/16BF ITR 1.9PLTD,PRBG	----	----	1131627	1131627
20/13	ROLLER,24-5/32BF ITR 1.9PLTD,PRBG	----	----	1131628	1131628
20/14	ROLLER,25-29/32BF ITR 1.9PLTD,PRBG	----	----	1131629	1131629
20/15	ROLLER,27-5/8BF ITR 1.9PLTD,PRBG	----	----	----	1140043
20/16	ROLLER,29-3/8BF ITR 1.9PLTD,PRBG	----	----	----	1140044
20/17	ROLLER,31-3/32BF ITR 1.9PLTD,PRBG	----	----	----	1140045
20/18	ROLLER,32-13/16BF ITR 1.9PLTD,PRBG	----	----	----	1140046
21	ROLLER, _ ITR 1.9" DIA PLTD (_ BF)	E0002412	E0002413	E0002414	E0006220
22	ROLLER,ITR _ BF 2G ITOH PM486FE-60	1138722	1138723	1138724	1138725
23	ROLLER,ITR SPUR 2G ITOH, 2C (3"GROOVE SPACING)	1126586	1126586	1126586	1126586
22	ROLLER,ITR 13.25BF 2G ITOH PM486FE-60	---	---	1139545	1139545
23	ROLLER,ITR 13.25BF 2G ITOH PM486FE-60 (USED W/IBE)	1165293	1165293	1165293	1165293
22	ROLLER,ITR _ BF 2G ITOH (USED W/IBE)	1163471	1163472	1163473	1163474
23	ROLLER,ITR SPUR 2G ITOH PM 486 FE-60 (3" GROOVE SPACING) (USED W/IBE)	1165292	1165292	1165292	1165292

Reference Dwg: 130A404

18.38.2 Replacement Parts - ITR Power Merge 2RC, 30 Degree

REPLACEMENT PARTS - ITR POWER MERGE, 2RC, 30 DEGREE					
PM,ITR-__BF-CB OR IBE-C6-2RC-30D-LH/RH-FE60		Width & Item #			
Balloon	Description	16 BF	22 BF	28 BF	34 BF
----	ELECTRICAL COMPONENTS	----	----	----	----
04	DRIVERCARD,ITOH CBM-105FP	1153930	1153930	1153930	1153930
04	DRIVERCARD,ITOH IB-E03BP	1166286	1166286	1166286	1166286
12	CONNECTOR,IDC SCOTCH LOK 567 - BROWN	3M567	3M567	3M567	3M567
----	CONNECTOR,IDC SCOTCHLOK 562 - YELLOW	3M562	3M562	3M562	3M562
----	CONNECTOR,IDC SCOTCH LOK 558 - RED (USED W/CB)	1120174	1120174	1120174	1120174
----	CONN,3 COND,W/LEVERS,28 - 12 AWG (USED W/CB)	1102816	1102816	1102816	1102816
----	CONN, WAGO 231-302/026-000 (USED W/IBE)	1162204	1162204	1162204	1162204
----	CABLE,MOTOR EXTENSION, 600,1200,OR 2700 MM LONG	REFERENCE CABLE, MOTOR EXTENSION USED WITH STATED DRIVER CARD			
----	CABLE,CTRLS-CAT5E_-GRAY	REFERENCE Cat5E COMMUNICATION CABLE			
---	HARNESS,POWER BROWN & BLUE (NOT BF SPECIFIC)	3'-0" L 1102289	5'-5" L 1102288	8'-0" L 1102287	10'-6" L 1102286
----	HARNESS,ITR-POWER-10AWG __L-MALE-PIGTAIL (NOT BF SPECIFIC)	3' L 1145664	4' L 1146344	7' L 1145663	10' L 1143291
----	SPUR, O-RINGS	----	----	----	----
17	ORING,3/16 DIA X 9.5" HT BLUE ITR 3"CTR (USED W/CB)	E0005536	E0005536	E0005536	E0005536
18	ORING,3/16" DIA X 15.312" HT BLUE FOR ITR 6.5" CTRS (20% STRETCH)	1167247	1167247	1167247	1167247
19	ORING,3/16 DIA X 7-3/4" HT BLUE ITR 2"CTR	1142656	1142656	1142656	1142656
----	ROLLER SET ITR-30D-2RC-SPUR	----	----	----	----
20/1	ROLLER,ITR 3-11/16" BF PRBG (NO AXLE) 1 GROOVE	1152360	1152360	1152360	1152360
20/2	ROLLER,ITR 4-3/4" BF PRBG (NO AXLE)	E0003268	E0003268	E0003268	E0003268
20/3	ROLLER,6BF ITR 1.9 PLTD PRBG	1152260	1152260	1152260	1152260
20/4	ROLLER,7-1/8BF ITR 1.9 PLTD PRBG	1152261	1152261	1152261	1152261
20/5	ROLLER,8-5/16BF ITR 1.9 PLTD PRBG	1152262	1152262	1152262	1152262
20/6	ROLLER,9-7/16BF ITR 1.9 PLTD PRBG	1152263	1152263	1152263	1152263
20/7	ROLLER,10-5/8BF ITR 1.9 PLTD PRBG	1152264	1152264	1152264	1152264
20/8	ROLLER,11-3/4BF ITR 1.9 PLTD PRBG	1152265	1152265	1152265	1152265
20/9	ROLLER,12-15/16BF ITR 1.9 PLTD PRBG	1152266	1152266	1152266	1152266
20/10	ROLLER,14-1/16BF ITR 1.9 PLTD PRBG	1152268	1152268	1152268	1152268
20/11	ROLLER,15-3/16BF ITR 1.9 PLTD PRBG	1152269	1152269	1152269	1152269
20/12	ROLLER,16-3/8BF ITR 1.9 PLTD PRBG	----	1155254	1155254	1155254
20/13	ROLLER,ITR 17-1/2"BF 1.9 PLTD PRBG	----	1133722	1133722	1133722
20/14	ROLLER,18-3/4BF ITR 1.9 PLTD PRBG	----	1154742	1154742	1154742
20/15	ROLLER,19-3/4BF ITR 1.9 PLTD PRBG	----	1144374	1144374	1144374
20/16	ROLLER,ITR 21"BF 1.9 PLTD PRBG	----	1133723	1133723	1133723
20/17	ROLLER,22-3/16BF ITR 1.9 PLTD PRBG	----	----	1155255	1155255
20/18	ROLLER,ITR 23-1/4"BF PRBG	----	----	1131992	1131992
20/19	ROLLER,ITR 24-7/16"BF PRBG 1.9 PLTD	----	----	1133724	1133724
20/20	ROLLER,25-5/8BF ITR 1.9 PLTD PRBG	----	----	1155256	1155256
20/21	ROLLER,26-3/4BF ITR 1.9 PLTD PRBG	----	----	1154745	1154745
20/22	ROLLER,ITR 27-15/16"BF PRBG 1.9 PLTD	----	----	----	1133726
20/23	ROLLER,29-1/16BF ITR 1.9 PLTD PRBG	----	----	----	1155257
20/24	ROLLER,30-1/4BF ITR 1.9 PLTD PRBG	----	----	----	1155258
20/25	ROLLER,ITR 31-3/8"BF PRBG 1.9 PLTD	----	----	----	1133728
20/26	ROLLER,32-1/2BF ITR 1.9 PLTD PRBG	----	----	----	1155259
21	ROLLER,__ITR 1.9" DIA PLTD (__BF)	E0002412	E0002413	E0002414	E0006220
22	ROLLER,ITR __BF 2G ITOH PM486FE-60 (USED W/CB)	1138722	1138723	1138724	1138725
22	ROLLER,ITR __BF 2G ITOH (USED W/CB)	----	----	1139545	1139545
23	ROLLER,ITR SPUR 2G ITOH,2C (2"GROOVE SPACING) (USED W/CB)	1152362	1152362	1152362	1152362
23	ROLLER,ITR SPUR 2G ITOH,2C, PM486 FE-60 (USED W/IBE)	1171592	1171592	1171592	1171592
22	ROLLER,ITR __BF 2G ITOH PM486 FE-60 (USED W/IBE)	1163471	1163472	1163473	1163474

Reference Dwg: 130A404

18.38.3 Replacement Parts - ITR Power Merge, 3RC, 45 Degree

REPLACEMENT PARTS - ITR POWER MERGE, 3RC, 45 DEGREE					
PM, ITR-__BF-CB OR IBE-C6-3RC-45D-LH/RH-FE60		Width & Item #			
Balloon	Description	16 BF	22 BF	28 BF	34 BF
---	ELECTRICAL COMPONENTS	---	---	---	---
04	DRIVERCARD, ITOH CBM-105FP	1153930	1153930	1153930	1153930
04	DRIVERCARD, ITOH IB-E03BP	1166286	1166286	1166286	1166286
---	CONNECTOR, IDC SCOTCH LOK 558 - RED	1120174	1120174	1120174	1120174
---	CONNECTOR, IDC SCOTCHLOK 562 - YELLOW	3M562	3M562	3M562	3M562
12	CONNECTOR, IDC SCOTCH LOK 567 - BROWN	3M567	3M567	3M567	3M567
---	CONN, 3 COND, W/LEVERS 28 - 12 AWG	1102816	1102816	1102816	1102816
---	CONN, WAGO 231-302/026-000	1162204	1162204	1162204	1162204
---	CABLE, MOTOR EXTENSION, 600, 1200, OR 2700 MM LONG	REFERENCE CABLE, MOTOR EXTENSION USED WITH STATED DRIVER CARD			
---	CABLE, CTRLS-CAT5E-_-GRAY	REFERENCE Cat5E COMMUNICATION CABLE			
---	CABLE, POWER CB-016/HB-510 14GA ITR (USED W/CB)	1139543	1139543	1139543	1139543
---	HARNESS, POWER BROWN & BLUE (NOT BF SPECIFIC)	3'-0" L 1102289	5'-5" L 1102288	8'-0" L 1102287	10'-6" L 1102286
---	HARNESS, ITR-POWER-10AWG _ _L-MALE-PIGTAIL (NOT BF SPECIFIC)	3' L 1145664	4' L 1146344	7' L 1145663	10' L 1143291
---	SPUR, O-RINGS	---	---	---	---
18	ORING, 3/16" DIA X 15.312" HT BLUE FOR ITR 6.5" CTRS (20% STRETCH)	1167247	1167247	1167247	1167247
17 & 19	ORING, 3/16 DIA X 9.5" HT BLUE, ITR 3"CTR	E0005536	E0005536	E0005536	E0005536
---	ROLLER SET ITR-45D-3RC-SPUR	---	---	---	---
20-01	ROLLER, ITR 4-3/4" BF PRBG (NO AXLE)	E0003268	E0003268	E0003268	E0003268
20-02	ROLLER, 7-3/4" BF ITR 1.9" DIA PLTD PRBG	1144370	114370	114370	1114370
20-03	ROLLER, 10-3/4" BF ITR 1.9" DIA PLTD PRBG	1144371	1144371	1144371	1144371
20-04	ROLLER, 13-3/4" BF ITR 1.9" DIA PLTD PRBG	1144372	1144372	1144372	1144372
20-05	ROLLER, 16-3/4" BF ITR 1.9" DIA PLTD PRBG	---	1144373	1144373	1144373
20-06	ROLLER, 19-3/4" BF ITR 1.9" DIA PLTD PRBG	---	1144374	1144374	1144374
20-07	ROLLER, 22-3/4" BF ITR 1.9" DIA PLTD PRBG	---	---	1144375	1144375
20-08	ROLLER, 25-3/4" BF ITR 1.9" DIA PLTD PRBG	---	---	1144376	1144376
20-09	ROLLER, 28-3/4" BF ITR 1.9" DIA PLTD PRBG	---	---	---	1144377
20-10	ROLLER, 31-3/4" BF ITR 1.9" DIA PLTD PRBG	---	---	---	1144378
21	ROLLER, _ _ ITR 1.9" DIA PLTD (_ _BF)	E0002412	E0002413	E0002414	E0006220
22	ROLLER, ITR _ _BF 2G ITOH PM486FE-60	1138722	1138723	1138724	1138725
23	ROLLER, ITR SPUR 2G ITOH, 2C (3" GROOVE SPACING)	1126586	1126586	1126586	1126586
22	ROLLER, ITR _ _BF 2G ITOH (USED W/IBE)	1163471	1163472	1163473	1163474
23	ROLLER, ITR SPUR 2G ITOH PM 486 FE-60 (3" GROOVE SPACING) (USED W/IBE)	1165292	1165292	1165292	1165292

Reference Dwg: 130A404

18.38.4 Replacement Parts - ITR Power Merge, 2RC, 45 Degree

REPLACEMENT PARTS - ITR POWER MERGE, CB, 2RC, 45 DEGREE					
PM,ITR-__BF-CB-C6-2RC-45D-LH/RH-FE60		Width & Item #			
Balloon	Description	16 BF	22 BF	28 BF	34 BF
---	ELECTRICAL COMPONENTS	---	---	---	---
04	DRIVERCARD, ITOH CBM-105FP	1153930	1153930	1153930	1153930
----	CONNECTOR, IDC SCOTCH LOK 558 - RED	1120174	1120174	1120174	1120174
12	CONNECTOR, IDC SCOTCH LOK 567 - BROWN	3M567	3M567	3M567	3M567
----	CONNECTOR, IDC SCOTCHLOK 562 - YELLOW	3M562	3M562	3M562	3M562
----	CONN, 3 COND, W/LEVERS 28 - 12 AWG	1102816	1102816	1102816	1102816
---	CABLE, MOTOR EXTENSION, 600, 1200, OR 2700 MM LONG	REFERENCE CABLE, MOTOR EXTENSION USED WITH STATED DRIVER CARD			
---	CABLE, CTRLS-CAT5E-_-GRAY	REFERENCE Cat5E COMMUNICATION CABLE			
--	HARNESS, POWER BROWN & BLUE (NOT BF SPECIFIC)	3'-0" L 1102289	5'-5" L 1102288	8'-0" L 1102287	10'-6" L 1102286
---	SPUR, O-RINGS	---	---	---	---
17	ORING, 3/16 DIA X 7-3/4" HT BLUE, ITR 2" CTR	E0034023	E0034023	E0034023	E0034023
18	ORING, 3/16" DIA X 15.312" HT BLUE FOR ITR 6.5" CTRS (20% STRETCH)	1167247	1167247	1167247	1167247
19	ORING, 3/16 DIA X 7-3/4" HT BLUE ITR 2" CTR	1142656	1142656	1142656	1142656
---	ROLLER SET ITR-30D-2RC-SPUR	---	---	---	---
20-01	ROLLER, ITR 4-3/4" BF PRBG (NO AXLE)	E0003268	E0003268	E0003268	E0003268
20-02	ROLLER, 8-3/4BF ITR 1.9PLTD	1154738	1154738	1154738	1154738
20-03	ROLLER, 6-3/4BF ITR 1.9PLTD	1154739	1154739	1174539	1174539
20-04	ROLLER, 12-3/4BF ITR 1.9PLTD	1144371	1144371	1144371	1144371
20-05	ROLLER, 14-3/4BF ITR 1.9PLTD	1154740	1154740	1154740	1154740
20-06	ROLLER, 16-3/4BF ITR 1.9PLTD	1154741	1154741	1154741	1154741
20-07	ROLLER, 18-3/4BF ITR 1.9PLTD	----	1144373	1144373	1144373
20-08	ROLLER, 20-3/4BF ITR 1.9PLTD	----	1154742	1154742	1154742
20-09	ROLLER, 22-3/4BF ITR 1.9PLTD	----	1154743	1154743	1154743
20-10	ROLLER, 24-3/4BF ITR 1.9PLTD	----	----	1144375	1144375
20-11	ROLLER, 26-3/4BF ITR 1.9PLTD	----	----	1154744	1154744
20-12	ROLLER, 30ITR 1.9PLTD PRBG	----	----	1154745	1154745
20-13	ROLLER, 28-3/4BF ITR 1.9" DIA PLTD PRBG	----	----	----	1144377
20-14	ROLLER, 30-3/4BF ITR 1.9" DIA PLTD PRBG	----	----	----	1155572
20-15	ROLLER, 32-3/4BF ITR 1.9" DIA PLTD PRBG	----	----	----	1155573
21	ROLLER, __ITR 1.9" DIA PLTD (__BF)	E0002412	E0002413	E0002414	E0006220
22	ROLLER, ITR __BF 2G ITOH PM486FE-60	1138722	1138723	1138724	1138725
23	ROLLER, ITR SPUR 2G ITOH, 2C (2" GROOVE SPACING)	1152362	1152362	1152362	1152362

Reference Dwg: 130A404

18.39 ITR SWEEP SPUR 45 DEGREE

18.39.1 ITR Sweep Spur 16BF

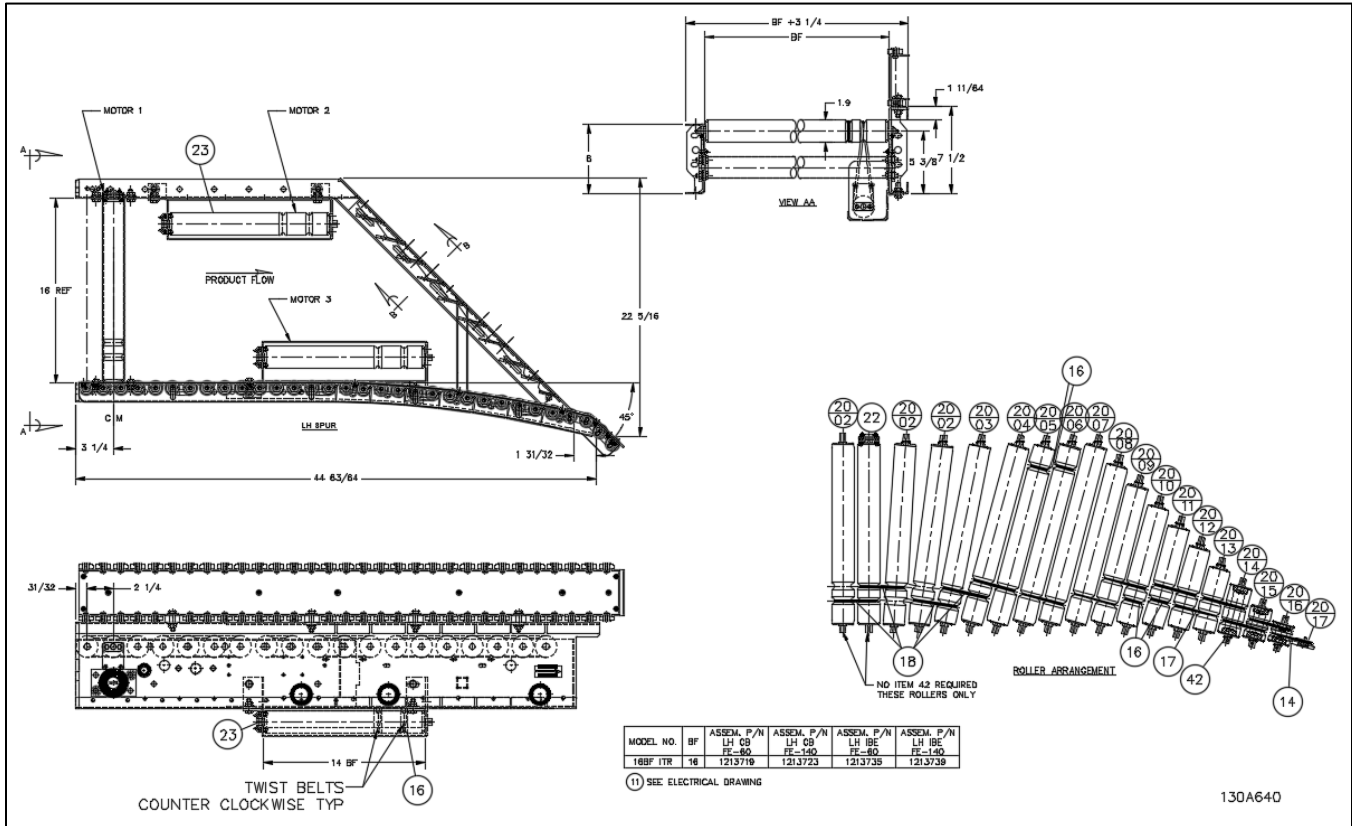

18.39.2 ITR Sweep Spur 22BF

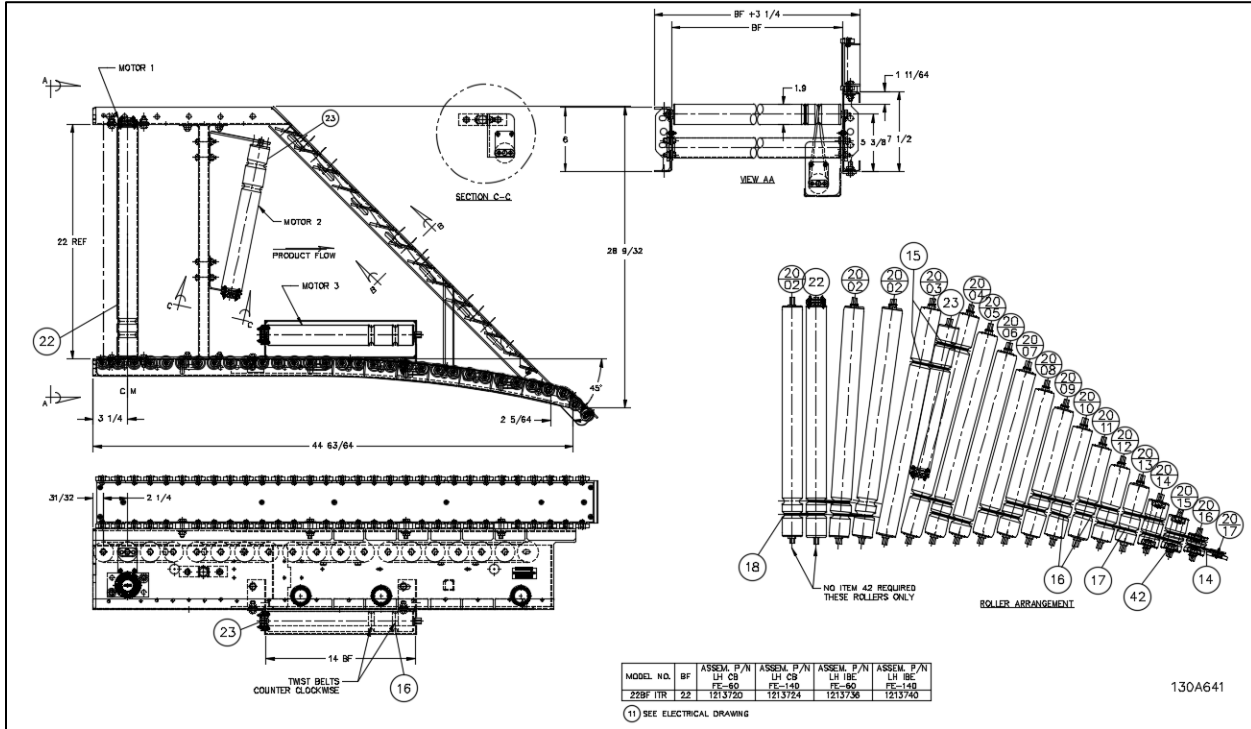

18.39.3 ITR Sweep Spur 28BF

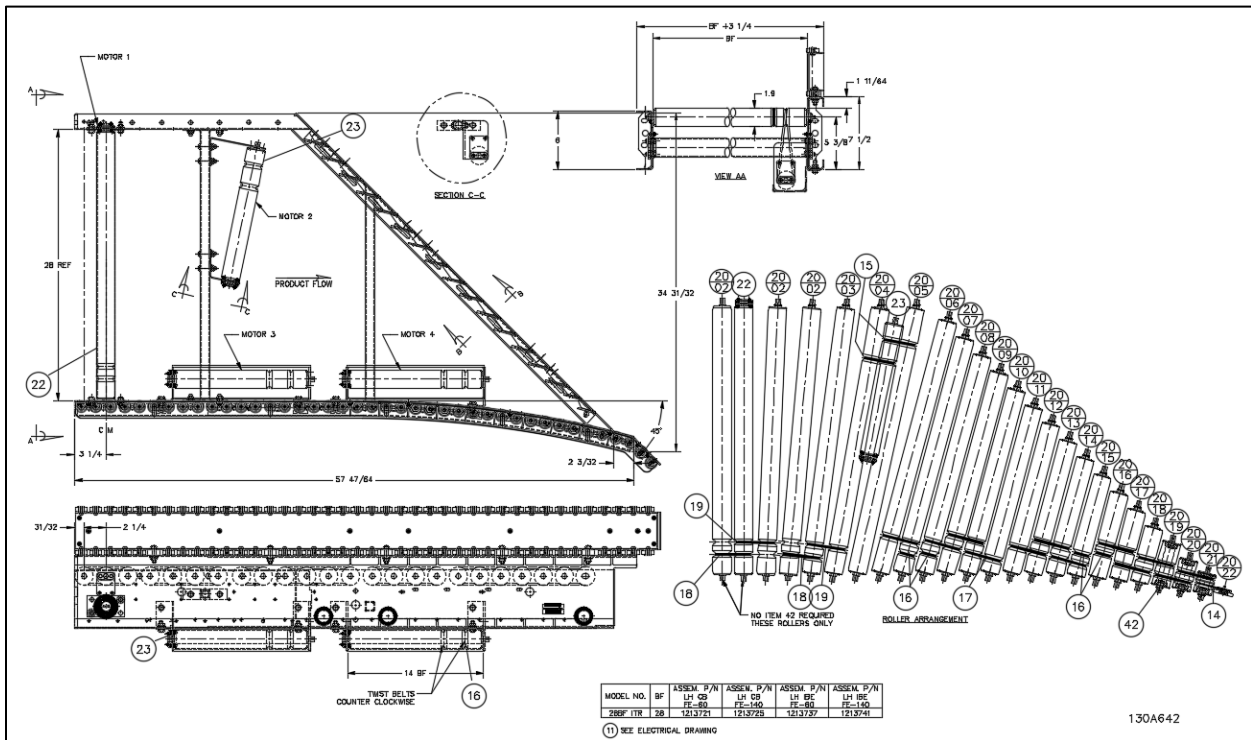

18.39.4 ITR Sweep Spur 34BF

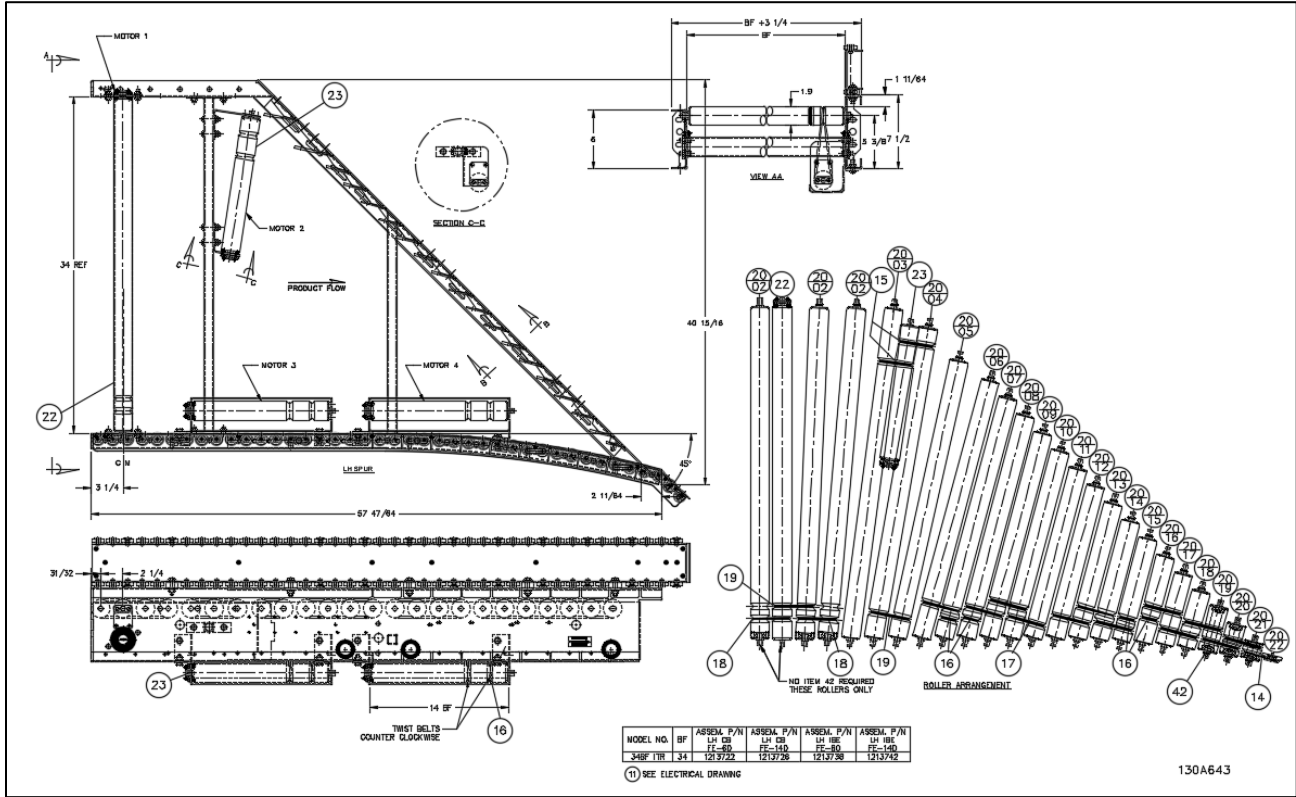

18.39.5 Replacement Parts – Reference Electrical Components

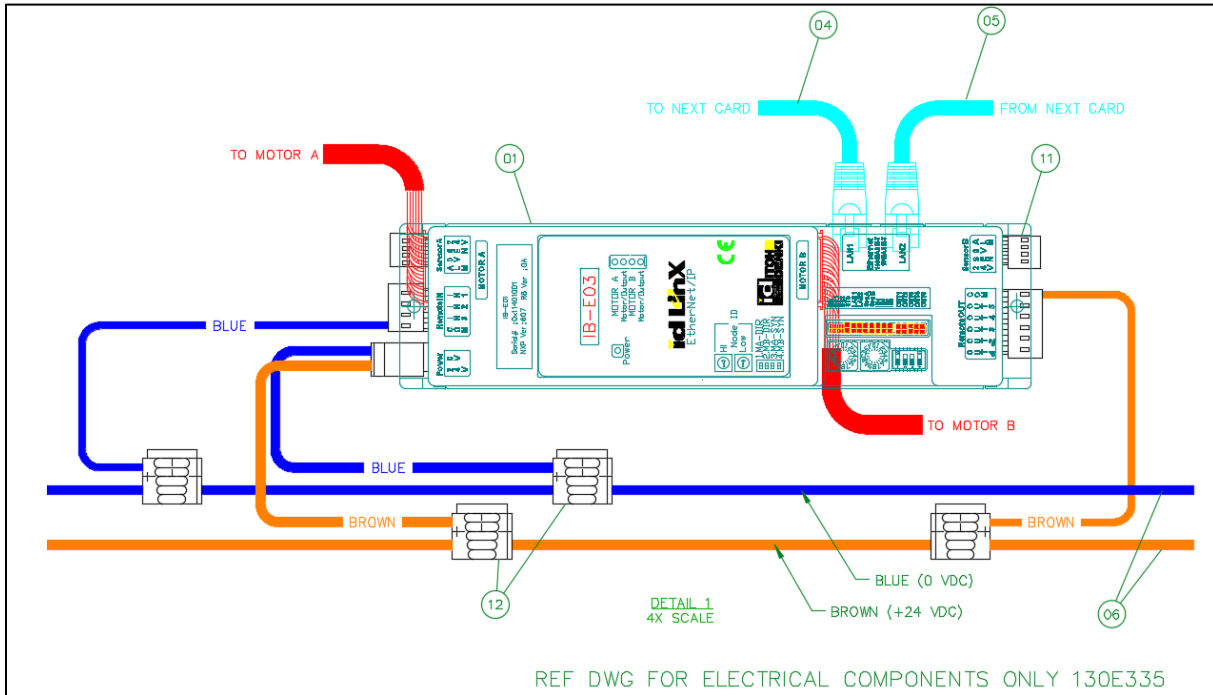

18.39.6 Replacement Parts – ITR Sweep Spur 2.25RC 45 Degree

REPLACEMENT PARTS - ITR SWEEP SPUR, 2.25RC, 45 DEGREE					
SPUR,ITR-	SPUR,ITR-__BF-CB OR IBE-C6-2.25RC-45D-LH/RH-3'6"-FE60-3MR-SWP-GEN3	Width & Item #			
Balloon	Description	16 BF	22 BF	28 BF	34 BF
---	ELECTRICAL COMPONENTS	---	---	---	---
01	DRIVERCARD, ITOH CB-016P7	1116036	1116036	1116036	1116036
01	DRIVERCARD, ITOH IB-E03BP	1166286	1166286	1166286	1166286
----	CABLE, MOTOR EXTENSION, 600, 1200, OR 2700 MM LONG	REFERENCE CABLE, MOTOR EXTENSION USED WITH STATED DRIVER CARD			
04 & 05	CABLE, CTRLS-CAT5E-_-GRAY (USED W/IBE)	REFERENCE Cat5E COMMUNICATION CABLE			
---	HARNES, POWER BROWN & BLUE (NOT BF SPECIFIC)	3'-0" L 1102289	5'-5" L 1102288	8'-0" L 1102287	10'-6" L 1102286
12	CONNECTOR, IDC SCOTCH LOK 567 - BROWN	3M567	3M567	3M567	3M567
11	CONNECTOR, IDC SCOTCH LOK 558 - RED (USED W/CB)	1120174	1120174	1120174	1120174
12	CONN, 3 COND, W/LEVERS 28 - 12 AWG (USED W/CB)	1102816	1102816	1102816	1102816
11	CONN, WAGO 231-302/026-000 (USED W/IBE)	1162204	1162204	1162204	1162204
---	SKATEWHEEL, ASY 6002 W/ADAPTER	1138618	1138618	1138618	1138618
---	SPUR, O-RINGS	---	---	---	---
14	ORING, 83A 1/8 X 8" CLEAR	E0001238	E0001238	E0001238	E0001238
15	ORING, 3/16 DIA X 13" HT BLUE	---	---	1103665	1103665
16	ORING, 3/16" DIA X 15.312" HT BLUE FOR ITR 6.5" CTRS (20% STRETCH)	1167247	1167247	1167247	1167247
17	ORING, 3/16 DIA X 8" HT BLUE	1142395	1142395	1142395	1142395
18	ORING, 3/16 DIA X 8-1/4" HT BLUE	E0034023	E0034023	E0034023	E0034023
19	ORING, 3/16 DIA X 8.688 HT BLUE	---	---	1137420	1137420
42	ORING, 1/2" ID (3/32 WALL)	90530050	90530050	90530050	90530050
---	ROLLER SET ITR SWEEP SPUR	---	---	---	---
20/02	ROLLER, ITR 1.9" DIA PLTD (_ BF)	E0002412	E0002413	E0002414	E0006220
20/03	ROLLER, ITR SWEEP SPUR, _ BF	1195553	1195564	1195575	1195591
20/04	ROLLER, ITR SWEEP SPUR, _ BF	1195554	1195565	1195576	1195592
20/05	ROLLER, ITR SWEEP SPUR, _ BF	1195555	1195566	1195577	1195593
20/06	ROLLER, ITR SWEEP SPUR, _ BF	1195556	1195567	1195578	1195594
20/07	ROLLER, ITR SWEEP SPUR, _ BF	1195557	1195568	1195579	1195595
20/08	ROLLER, ITR SWEEP SPUR, _ BF	1195558	1195569	1195580	1195596
20/09	ROLLER, ITR SWEEP SPUR, _ BF	1195559	1195570	1195581	1195597
20/10	ROLLER, ITR SWEEP SPUR, _ BF	1195560	1195571	1195582	1195598
20/11	ROLLER, ITR SWEEP SPUR, _ BF	1195561	1195572	1195583	1195599
20/12	ROLLER, ITR SWEEP SPUR, _ BF	1195562	1195573	1195584	1195600
20/13	ROLLER, ITR SWEEP SPUR, _ BF	1195563	1195574	1195585	1195601
20/14	ROLLER, ITR SWEEP SPUR, _ BF	1205985	1205985	1195586	1195602
20/15	ROLLER, ITR SWEEP SPUR, _ BF	1205984	1205987	1195587	1195603
20/16	ROLLER, ITR SWEEP SPUR, _ BF	1205986	1205986	1195588	1195604
20/17	ROLLER, ITR SWEEP SPUR, _ BF	1160266	1160266	1195589	1195605
20/18	ROLLER, ITR SWEEP SPUR, _ BF	---	---	1195590	1195606
20/19	ROLLER, ITR SWEEP SPUR, _ BF	---	---	1205988	1205990
20/20	ROLLER, ITR SWEEP SPUR, _ BF	---	---	1205989	1205991
20/21	ROLLER, ITR SWEEP SPUR, _ BF	---	---	1205990	1205992
20/22	WHEEL, ASY NBS30 ALUM. SMOOTH	---	---	1160266	1160266
----	BRG, 6002ZC3SRI2-Q	1179675	1179675	1179675	1179675
22	ROLLER, ITR 13.25BF 2G ITOH PM486FE-140 (USED W/CB-016)	1168560	1134452	1142856	1155281
23	ROLLER, ITR 14BF 2G ITOH - FE-140 (USED W/CB-016)	1168164	1168164	1168164	1168164
22	ROLLER, ITR _ BF 2G ITOH (USED W/ IBE)	1196022	1167730	1166001	1171660
23	ROLLER, ITR 14BF 2G ITOH (USED W/ IBE)	1180186	1180186	1180186	1180186

Reference Dwg: 130A640 - 130A643

18.40 ITR WHEEL DIVERT (PNEUMATIC)

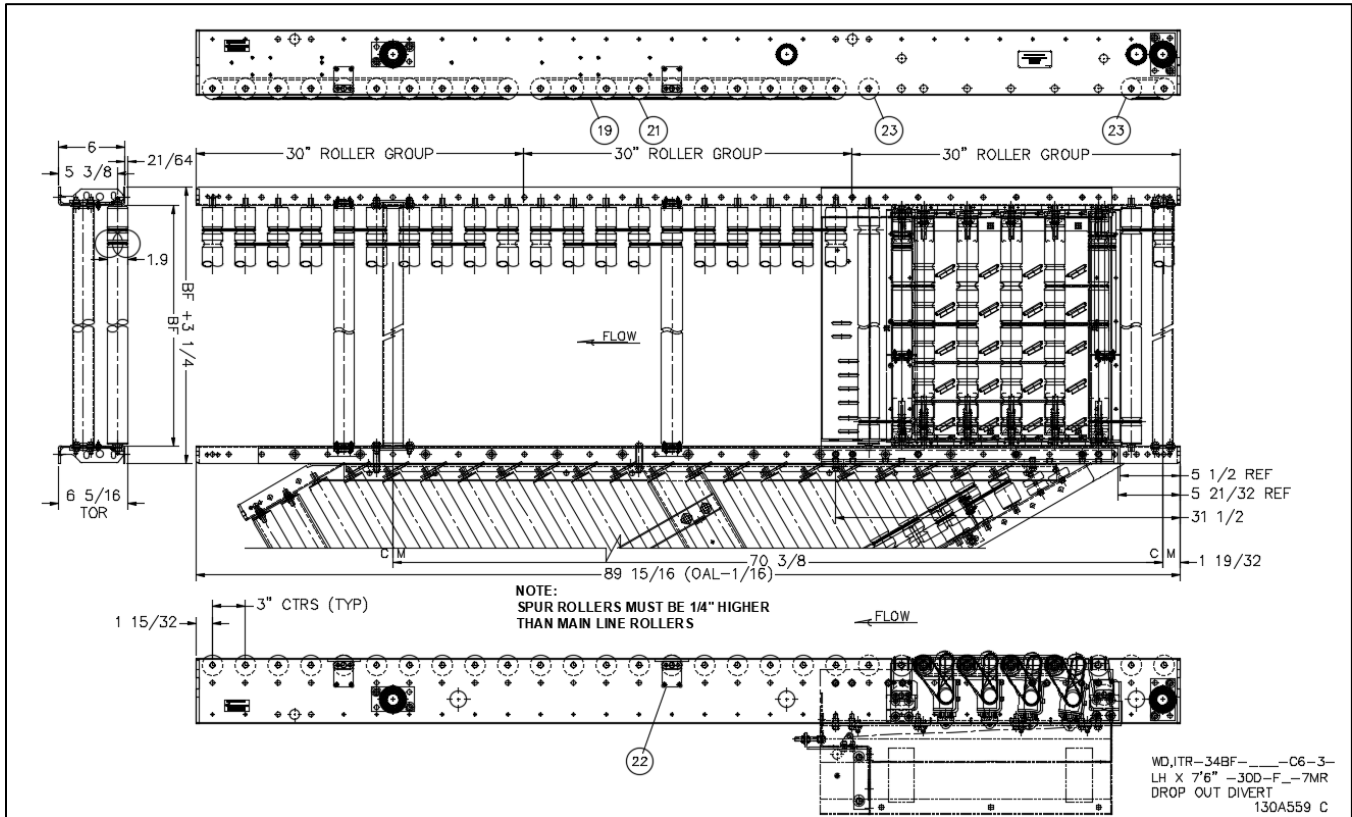

a) Replacement Parts – ITR Wheel Divert, CBM-105, 3RC (Pneumatic)

REPLACEMENT PARTS - ITR WHEEL DIVERT PNEUMATIC, CB, 3RC, 30 DEGREES					
WD, ITR- _ _BF-CB-C6-3RC-30D-LH/RH-FE60- _MR- _SOL-W/DROPOUT		Width & Item #			
Balloon	Description	16 BF	22 BF	28 BF	34 BF
----	ELECTRICAL COMPONENTS	----	----	----	----
1	DRIVERCARD, ITOH CBM-105FP	1153930	1153930	1153930	1153930
----	CONNECTOR, IDC SCOTCH LOK 558 - RED	1120174	1120174	1120174	1120174
12	CONNECTOR, IDC SCOTCH LOK 567 - BROWN	3M567	3M567	3M567	3M567
----	CONN, 3 COND, W/LEVERS 28 - 12 AWG	1102816	1102816	1102816	1102816
----	CABLE, MOTOR EXTENSION, 600, 1200, OR 2700 MM LONG	REFERENCE CABLE, MOTOR EXTENSION USED WITH STATED DRIVER CARD			
----	HARNESS, POWER BROWN & BLUE (NOT BF SPECIFIC)	3'-0" L 1102289	5'-5" L 1102288	8'-0" L 1102287	10'-6" L 1102286
---	DIVERTER WAVE	---	---	---	---
1	CYL, AIR, 1" BORE, 2" STROKE	1109080	1109080	1109080	1109080
9	ROLLER, WD _ _BF ITR PRBG DROP OUT TUB	1195066	1191359	1194883	1198388
10	ROLLER, WD _ _BF ITR PRBG, 5 GRV DROP OUT TUB	1195067	1191372	1194884	1198402
3	ROLLER, ITR 13.25BF 2G ITOH PM486FE-60	1191381	1191381	1191381	1191381
2	WHEEL, ASY NBS30 (MOLDED TIRE) ALUMINUM	1158076	1158076	1158076	1158076
4	WHEEL, ASY IDLER NBS30 ALUMINUM	1158077	1158077	1158077	1158077
---	TUBING, 1/4" POLYU-95DURO. 160ID	E0001391	E0001391	E0001391	E0001391
25	ORING, 83A WD 3/16 X 25-3/8"	1141505	1141505	1141505	1141505
26	ORING, 3/16 DIA X 7-3/4" HT BLUE ITR 2" CTR	1142656	1142656	1142656	1142656
27	ORING, .210 DIA X 9.1" HT RED ITR 2.75" CTR	1172694	1172694	1172694	1172694
28	ORING, 83A 1/8" X 10"	1141229	1141229	1141229	1141229
29	ORING, 83A 1/8 X 9-1/4" BLACK	E0001239	E0001239	E0001239	E0001239
37	ORING, 3/16 DIA X 14.5" HT BLUE 6" CTR	1172695	1172695	1172695	1172695
38	ORING, 3/16 DIA X 11" HT BLUE ITR 4" CTR	1127703	1127703	1127703	1127703
39	ORING, 3/16 DIA X 17.95" HT BLUE 8" CTR	1172696	1172696	1172696	1172696
----	SPUR, O-RINGS	----	----	----	----
18	ORING, 3/16 DIA X 17.95" HT BLUE 8" CTR	1167247	1167247	1167247	1167247
17 & 19	ORING, 3/16 DIA X 9.5" HT BLUE, ITR 3" CTR	E0005536	E0005536	E0005536	E0005536
----	ROLLER SET ITR-30D-3RC-SPUR	----	----	----	----
20/1	ROLLER, ITR 3-3/8" BF PRBG NO AXLE	1143249	1143249	1143249	1143249
20/2	ROLLER, ITR 5-1/8" BF PRBG NO AXLE	1130836	1130836	1130836	1130836
20/3	ROLLER, 6-27/32BF ITR 1.9 PLTD PRBG	1131620	1131620	1131620	1131620
20/4	ROLLER, 8-9/16BF ITR 1.9 PLTD PRBG	1131621	1131621	1131621	1131621
20/5	ROLLER, 10-5/16BF ITR 1.9 PLTD PRBG	1143250	1143250	1143250	1143250
20/6	ROLLER, 12-1/32BF ITR 1.9 PLTD PRBG	1131622	1131622	1131622	1131622
20/7	ROLLER, 13-25/32BF ITR 1.9 PLTD PRBG	1131623	1131623	1131623	1131623
20/8	ROLLER, 15-1/2BF ITR 1.9 PLTD PRBG	----	1131624	1131624	1131624
20/9	ROLLER, 17-1/4BF ITR 1.9 PLTD PRBG	----	1143251	1143251	1143251
20/10	ROLLER, 18-31/32BF ITR 1.9 PLTD PRBG	----	1131625	1131625	1131625
20/11	ROLLER, 20-11/16BF ITR 1.9 PLTD PRBG	----	1143252	1143252	1143252
20/12	ROLLER, 22-7/16BF ITR 1.9 PLTD PRBG	----	----	1131627	1131627
20/13	ROLLER, 24-5/32BF ITR 1.9 PLTD PRBG	----	----	1131628	1131628
20/14	ROLLER, 25-29/32BF ITR 1.9 PLTD PRBG	----	----	1131629	1131629
20/15	ROLLER, 27-5/8BF ITR 1.9 PLTD PRBG	----	----	----	1140043
20/16	ROLLER, 29-3/8BF ITR 1.9 PLTD PRBG	----	----	----	1140044
20/17	ROLLER, 31-3/32BF ITR 1.9 PLTD PRBG	----	----	----	1140045
20/18	ROLLER, 32-13/16BF ITR 1.9 PLTD PRBG	----	----	----	1140046
21	ROLLER, _ ITR 1.9" DIA PLTD (_ BF)	E0002412	E0002413	E0002414	E0006220
22	ROLLER, ITR _ BF 2G ITOH	----	----	1139545	1139545
22	ROLLER, ITR _ BF 2G ITOH PM486FE-60	1138722	1138723	1138724	1138725
23	ROLLER, _ ITR 1.9 PLTD PRBG 1D1S (_ BF)	E0002422	E0002423	E0002424	1198370
23	ROLLER, ITR SPUR 2G ITOH, 2C (3" GROOVE SPACING)	1126586	1126586	1126586	1126586

Ref Dwg# 130A559

18.40.1 Replacement Parts – ITR Wheel Divert, CBM-105, 2RC (Pneumatic)

REPLACEMENT PARTS - ITR WHEEL DIVERT PNEUMATIC, CB, 2RC, 30 DEGREES					
WD,ITR-__BF-CB-C6-2RC-30D-LH/RH-FE60- MR-__SOL-W/DROPOUT		Width & Item #			
Balloon	Description	16 BF	22 BF	28 BF	34 BF
---	ELECTRICAL COMPONENTS	---	---	---	---
1	DRIVERCARD,ITOH CBM-105FP	1153930	1153930	1153930	1153930
12	CONNECTOR,IDC SCOTCH LOK 567 - BROWN	3M567	3M567	3M567	3M567
11	CONNECTOR,IDC SCOTCH LOK 558 - RED	1120174	1120174	1120174	1120174
2	CONN, 3 COND, W/LEVERS	1102816	1102816	1102816	1102816
---	CABLE,MOTOR EXTENSION, 600,1200,OR 2700 MM LONG	REFERENCE CABLE, MOTOR EXTENSION USED WITH STATED DRIVER CARD			
---	CABLE,CTRLS-CAT5E-1-GRAY	REFERENCE Cat5E COMMUNICATION CABLE			
---	DIVERTER WAVE	---	---	---	---
---	CYL,AIR,1" BORE,2" STROKE	1109080	1109080	1109080	1109080
---	ROLLER,WD __BF ITR PRBG DROP OUT TUB	1195066	1191359	1194883	1198388
---	ROLLER,WD __BF ITR PRBG,5 GRV DROP OUT TUB	1195067	1191372	1194884	1198402
2	WHEEL,ASY NBS30 (MOLDED TIRE) ALUMINUM	1158076	1158076	1158076	1158076
4	WHEEL,ASY IDLER NBS30 ALUMINUM	1158077	1158077	1158077	1158077
---	TUBING,1/4"POLYU-95DURO,160ID	E0001391	E0001391	E0001391	E0001391
3	ROLLER,ITR 13.25BF 2G ITOH	1191381	1191381	1191381	1191381
25	ORING,83A WD 3/16 X 25-3/8"	1141505	1141505	1141505	1141505
26	ORING,3/16DIA X 7-3/4" HT BLUE ITR 2"CTR	1142656	1142656	1142656	1142656
27	ORING, .210 DIA X 9.1" HT RED ITR 2.75"CTR	1172694	1172694	1172694	1172694
28	ORING,83A 1/8" X 10"	1141229	1141229	1141229	1141229
29	ORING,83A 1/8 X 9-1/4" BLACK	E0001239	E0001239	E0001239	E0001239
37	ORING,3/16DIA X 14.5" HT BLUE 6" CTR	1172695	1172695	1172695	1172695
38	ORING,3/16DIA X 11" HT BLUE ITR 4"CTR	1127703	1127703	1127703	1127703
39	ORING,3/16DIA X 17.95" HT BLUE 8" CTR	1172696	1172696	1172696	1172696
---	SPUR, O-RINGS	---	---	---	---
17	ORING,3/16DIA X 9.5" HT BLUE ITR 3"CTR	E0005536	E0005536	E0005536	E0005536
18	ORING,3/16DIA X 15.312 HT BLUE FOR ITR 6.5 CTRS,20% STRETCH	1167247	1167247	1167247	1167247
18	ORING,3/16DIA X 8-1/4" HT BLUE	E0034023	E0034023	E0034023	E0034023
19	ORING,3/16DIA X 7-3/4" HT BLUE ITR 2"CTR	1142656	1142656	1142656	1142656
---	ROLLER SET-2RC-30D-SPUR	---	---	---	---
20/1	ROLLER,ITR 3-11/16" BF PRBG (NO AXLE) 1 GROOVE	1152360	1152360	1152360	1152360
20/2	ROLLER,ITR 4-3/4"BF PRBG NO AXLE	E0003268	E0003268	E0003268	E0003268
20/3	ROLLER,6BF ITR 1.9 PLTD PRBG	1152260	1152260	1152260	1152260
20/4	ROLLER,7-1/8BF ITR 1.9 PLTD PRBG	1152261	1152261	1152261	1152261
20/5	ROLLER,8-5/16BF ITR 1.9 PLTD PRBG	1152262	1152262	1152262	1152262
20/6	ROLLER,9-7/16BF ITR 1.9 PLTD PRBG	1152263	1152263	1152263	1152263
20/7	ROLLER,10-5/8BF ITR 1.9 PLTD PRBG	1152264	1152264	1152264	1152264
20/8	ROLLER,11-3/4BF ITR 1.9 PLTD PRBG	1152265	1152265	1152265	1152265
20/9	ROLLER,12-15/16BF ITR 1.9 PLTD PRBG	1152266	1152266	1152266	1152266
20/10	ROLLER,14-1/16BF ITR 1.9 PLTD PRBG	1152268	1152268	1152268	1152268
20/11	ROLLER,15-3/16BF ITR 1.9 PLTD PRBG	1152269	1152269	1152269	1152269
20/12	ROLLER,16-3/8BF ITR 1.9 PLTD PRBG	---	1155254	1155254	1155254
20/13	ROLLER,ITR 17-1/2"BF 1.9 PLTD PRBG	---	1133722	1133722	1133722
20/14	ROLLER,18-3/4BF ITR 1.9 PLTD PRBG	---	1154742	1154742	1154742
20/15	ROLLER,19-3/4BF ITR 1.9 PLTD PRBG	---	1144374	1144374	1144374
20/16	ROLLER,ITR 21"BF 1.9 PLTD PRBG	---	1133723	1133723	1133723
20/17	ROLLER,22-3/16BF ITR 1.9 PLTD PRBG	---	---	1155255	1155255
20/18	ROLLER,ITR 23-1/4"BF PRBG	---	---	1131992	1131992
20/19	ROLLER,ITR 24-7/16"BF PRBG1.9 PLTD	---	---	1133724	1133724
20/20	ROLLER,25-5/8BF ITR 1.9 PLTD PRBG	---	---	1155256	1155256
20/21	ROLLER,26-3/4BF ITR 1.9 PLTD PRBG	---	---	1154745	1154745
20/22	ROLLER,ITR 27-15/16"BF PRBG1.9 PLTD	---	---	---	1133726
20/23	ROLLER,29-1/16BF ITR 1.9 PLTD PRBG	---	---	---	1155257
20/24	ROLLER,30-1/4BF ITR 1.9 PLTD PRBG	---	---	---	1155258
20/25	ROLLER,ITR 31-3/8"BF PRBG1.9 PLTD	---	---	---	1133728
20/26	ROLLER,32-1/2BF ITR 1.9 PLTD PRBG	---	---	---	1155259
20	ROLLER,__ITR 1.9 PLTD PRBG 1D1S (_BF)	E0002422	E0002423	E0002424	1198370
21	ROLLER,__ITR 1.9" DIA PLTD (_BF)	E0002412	E0002413	E0002414	E0006220
22	ROLLER,ITR __BF 2G ITOH	---	---	1139545	1139545
22	ROLLER,ITR __BF 2G ITOH PM486FE-60	1138722	1138723	1138724	1138725
23	ROLLER,ITR SPUR 2G ITOH,2C (2"GROOVE SPACING)	1152362	1152362	1152362	1152362
23	ROLLER,__ITR 1.9PLTD PRBG1D1S (_BF)	---	---	1198370	1198370

Ref Dwg# 130A559

18.40.2 Replacement Parts – ITR Wheel Divert, IB-E03, 3RC (Pneumatic)

REPLACEMENT PARTS - ITR WHEEL DIVERT PNEUMATIC, IB-E03, 3RC, 30 DEGREES					
WD,ITR,_ _BF-IBE-C6-3RC-30D-LH/RH-FE60-_MR-_SOL-W/DROPOUT		Width & Item #			
Balloon	Description	16 BF	22 BF	28 BF	34 BF
---	ELECTRICAL COMPONENTS	----	----	----	----
04	DRIVERCARD,ITOH IB-E03BP	1166286	1166286	1166286	1166286
12	CONNECTOR,IDC SCOTCH LOK 567 - BROWN	3M567	3M567	3M567	3M567
---	CONNECTOR,IDC SCOTCHLOK 562 - YELLOW	3M562	3M562	3M562	3M562
---	CONNECTOR,IDC SCOTCH LOK 564 - WHITE	---	---	3M564	3M564
---	CONN, WAGO 231-302/026-000	1162204	1162204	1162204	1162204
---	CABLE,MOTOR EXTENSION, 600,1200,OR 2700 MM LONG	REFERENCE CABLE, MOTOR EXTENSION USED WITH STATED DRIVER CARD			
---	CABLE,CTRLS-CAT5E-_-GRAY	REFERENCE Cat5E COMMUNICATION CABLE			
---	DIVERTER WAVE	---	---	---	---
1	CYL,AIR,1" BORE, 2" STROKE	1109080	1109080	1109080	1109080
9	ROLLER,WD _BF ITR PRBG DROP OUT TUB	1195066	1191359	1194883	1198388
10	ROLLER,WD _BF ITR PRBG,5 GRV DROP OUT TUB	1195067	1191372	1194884	1198402
3	ROLLER,ITR 13.25BF 2G ITOHPM486FE-60	1198348	1198348	1198348	1198348
2	WHEEL,ASY NBS30 (MOLDED TIRE) ALUMINUM	1158076	1158076	1158076	1158076
4	WHEEL,ASY IDLER NBS30 ALUMINUM	1158077	1158077	1158077	1158077
---	TUBING,1/4"POLYU-95DURO.160ID	E0001391	E0001391	E0001391	E0001391
25	ORING,83A WD 3/16 X 25-3/8"	1141505	1141505	1141505	1141505
26	ORING,3/16 DIA X 7-3/4" HT BLUE ITR 2"CTR	1142656	1142656	1142656	1142656
27	ORING, .210 DIA X 9.1" HT REDITR 2.75"CTR	1172694	1172694	1172694	1172694
28	ORING,83A 1/8" X 10"	1141229	1141229	1141229	1141229
29	ORING,83A 1/8 X 9-1/4" BLACK	E0001239	E0001239	E0001239	E0001239
37	ORING,3/16 DIA X 14.5" HT BLUE 6" CTR	1172695	1172695	1172695	1172695
38	ORING,3/16 DIA X 11" HT BLUE ITR 4"CTR	1127703	1127703	1127703	1127703
39	ORING,3/16 DIA X 17.95" HT BLUE 8" CTR	1172696	1172696	1172696	1172696
---	SPUR, O-RINGS	---	---	---	---
18	ORING,3/16" DIA X 15.312" HT BLUE FOR ITR 6.5" CTRS (20% STRETCH)	1167247	1167247	1167247	1167247
17 & 19	ORING,3/16 DIA X 9.5" HT BLUE ITR 3"CTR	E0005536	E0005536	E0005536	E0005536
----	ROLLER SET ITR-3RC-30D	----	----	----	----
20/1	ROLLER,ITR 3-3/8"BF PRBG NO AXLE	1143249	1143249	1143249	1143249
20/2	ROLLER,ITR 5-1/8"BF PRBG NO AXLE	1130836	1130836	1130836	1130836
20/3	ROLLER,6-27/32BF ITR 1.9 PLTD PRBG	1131620	1131620	1131620	1131620
20/4	ROLLER,8-9/16BF ITR 1.9 PLTD PRBG	1131621	1131621	1131621	1131621
20/5	ROLLER,10-5/16BF ITR 1.9 PLTD PRBG	1143250	1143250	1143250	1143250
20/6	ROLLER,12-1/32BF ITR 1.9 PLTD PRBG	1131622	1131622	1131622	1131622
20/7	ROLLER,13-25/32BF ITR 1.9 PLTD PRBG	1131623	1131623	1131623	1131623
20/8	ROLLER,15-1/2BF ITR 1.9 PLTD PRBG	---	1131624	1131624	1131624
20/9	ROLLER,17-1/4BF ITR 1.9 PLTD PRBG	---	1143251	1143251	1143251
20/10	ROLLER,18-31/32BF ITR 1.9 PLTD PRBG	---	1131625	1131625	1131625
20/11	ROLLER,20-11/16BF ITR 1.9 PLTD PRBG	---	1143252	1143252	1143252
20/12	ROLLER,22-7/16BF ITR 1.9 PLTD PRBG	---	---	1131627	1131627
20/13	ROLLER,24-5/32BF ITR 1.9 PLTD PRBG	---	---	1131628	1131628
20/14	ROLLER,25-29/32BF ITR 1.9 PLTD PRBG	---	---	1131629	1131629
20/15	ROLLER,27-5/8BF ITR 1.9 PLTD PRBG	---	---	---	1140043
20/16	ROLLER,29-3/8BF ITR 1.9 PLTD PRBG	---	---	---	1140044
20/17	ROLLER,31-3/32BF ITR 1.9 PLTD PRBG	---	---	---	1140045
20/18	ROLLER,32-13/16BF ITR 1.9 PLTD PRBG	---	---	---	1140046
21	ROLLER,_ITR 1.9" DIA PLTD (_BF)	E0002412	E0002413	E0002414	E0006220
22	ROLLER,ITR _BF 2G ITOH PM486FE-60	1163471	1163472	1163473	1163474
22	ROLLER,ITR 13.25BF 2G ITOH PM486FE-60	---	---	1165293	1165293
23	ROLLER,_ITR 1.9PLTD PRBG 1D1S (_BF)	E0002422	E0002423	E0002424	1198370
23	ROLLER,ITR SPUR 2G ITOH PM 486 FE-60 (3" GROOVE SPACING)	1165292	1165292	1165292	1165292

REF DWG# 130A559

18.40.3 Replacement Parts – ITR Wheel Divert, IB-E03, 2RC (Pneumatic)

REPLACEMENT PARTS - ITR WHEEL DIVERT PNEUMATIC, IB-E03, 2RC, 30 DEGREES					
WD, ITR-	BF-IBE-C6-2RC-30D-LH/RH- MR-FE60- SOL-W/DROPOUT	Width & Item #			
Balloon	Description	16 BF	22 BF	28 BF	34 BF
---	ELECTRICAL COMPONENTS	---	---	---	---
---	DRIVERCARD, ITOH IB-E03BP	1166286	1166286	1166286	1166286
---	CONNECTOR, IDC SCOTCH LOK 567 - BROWN	3M567	3M567	3M567	3M567
---	CONN, WAGO 231-302/026-000	1162204	1162204	1162204	1162204
---	CONNECTOR, IDC SCOTCHLOK 562 - YELLOW	3M562	3M562	3M562	3M562
---	CONNECTOR, IDC SCOTCH LOK 564 - WHITE	3M564	3M564	3M564	3M564
---	CABLE, MOTOR EXTENSION, 600, 1200, OR 2700 MM LONG	REFERENCE CABLE, MOTOR EXTENSION USED WITH STATED DRIVER CARD			
---	CABLE, CTRLS-CAT5E-_-GRAY	REFERENCE Cat5E COMMUNICATION CABLE			
3	ROLLER, ITR _ BF 2G ITOH PM486FE-60 (USED W/ IBE)	1163471	1163472	1163473	1163474
---	DIVERter WAVE	---	---	---	---
---	CYL, AIR, 1" BORE, 2" STROKE	1109080	1109080	1109080	1109080
---	ROLLER, WD _ BF ITR PRBG DROP OUT TUB	1195066	1191359	1194883	1198388
---	ROLLER, WD _ BF ITR PRBG, 5 GRV DROP OUT TUB	1195067	1191372	1194884	1198402
2	WHEEL, ASY NBS30 (MOLDED TIRE) ALUMINUM	1158076	1158076	1158076	1158076
4	WHEEL, ASY IDLER NBS30 ALUMINUM	1158077	1158077	1158077	1158077
3	ROLLER, ITR 13.25BF 2G ITOH	1198348	1198348	1198348	1198348
25	ORING, 83A WD 3/16 X 25-3/8"	1141505	1141505	1141505	1141505
26	ORING, 3/16DIA X 7-3/4" HT BLUE ITR 2"CTR	1142656	1142656	1142656	1142656
27	ORING, .210 DIA X 9.1" HT RED ITR 2.75"CTR	1172694	1172694	1172694	1172694
28	ORING, 83A 1/8" X 10"	1141229	1141229	1141229	1141229
29	ORING, 83A 1/8 X 9-1/4" BLACK	E0001239	E0001239	E0001239	E0001239
37	ORING, 3/16DIA X 14.5" HT BLUE 6" CTR	1172695	1172695	1172695	1172695
38	ORING, 3/16DIA X 11" HT BLUE ITR 4"CTR	1127703	1127703	1127703	1127703
39	ORING, 3/16DIA X 17.95" HT BLUE 8" CTR	1172696	1172696	1172696	1172696
---	SPUR, O-RINGS	---	---	---	---
17	ORING, 3/16DIA X 9.5" HT BLUE ITR 3"CTR	E0005536	E0005536	E0005536	E0005536
18	ORING, 3/16DIA X 15.312 HT BLUE FOR ITR 6.5 CTRS, 20% STRETCH	1167247	1167247	1167247	1167247
18	ORING, 3/16DIA X 8-1/4" HT BLUE	E0034023	E0034023	E0034023	E0034023
19	ORING, 3/16DIA X 7-3/4" HT BLUE ITR 2"CTR	1142656	1142656	1142656	1142656
---	ROLLER SET-2RC-30D-SPUR	---	---	---	---
20/1	ROLLER, ITR 3-11/16" BF PRBG (NO AXLE) 1 GROOVE	1152360	1152360	1152360	1152360
20/2	ROLLER, ITR 4-3/4" BF PRBG NO AXLE	E0003268	E0003268	E0003268	E0003268
20/3	ROLLER, 6BF ITR 1.9 PLTD PRBG	1152260	1152260	1152260	1152260
20/4	ROLLER, 7-1/8BF ITR 1.9 PLTD PRBG	1152261	1152261	1152261	1152261
20/5	ROLLER, 8-5/16BF ITR 1.9 PLTD PRBG	1152262	1152262	1152262	1152262
20/6	ROLLER, 9-7/16BF ITR 1.9 PLTD PRBG	1152263	1152263	1152263	1152263
20/7	ROLLER, 10-5/8BF ITR 1.9 PLTD PRBG	1152264	1152264	1152264	1152264
20/8	ROLLER, 11-3/4BF ITR 1.9 PLTD PRBG	1152265	1152265	1152265	1152265
20/9	ROLLER, 12-15/16BF ITR 1.9 PLTD PRBG	1152266	1152266	1152266	1152266
20/10	ROLLER, 14-1/16BF ITR 1.9 PLTD PRBG	1152268	1152268	1152268	1152268
20/11	ROLLER, 15-3/16BF ITR 1.9 PLTD PRBG	1152269	1152269	1152269	1152269
20/12	ROLLER, 16-3/8BF ITR 1.9 PLTD PRBG	---	1155254	1155254	1155254
20/13	ROLLER, ITR 17-1/2" BF 1.9 PLTD PRBG	---	1133722	1133722	1133722
20/14	ROLLER, 18-3/4BF ITR 1.9 PLTD PRBG	---	1154742	1154742	1154742
20/15	ROLLER, 19-3/4BF ITR 1.9 PLTD PRBG	---	1144374	1144374	1144374
20/16	ROLLER, ITR 21" BF 1.9 PLTD PRBG	---	1133723	1133723	1133723
20/17	ROLLER, 22-3/16BF ITR 1.9 PLTD PRBG	---	---	1155255	1155255
20/18	ROLLER, ITR 23-1/4" BF PRBG	---	---	1131992	1131992
20/19	ROLLER, ITR 24-7/16" BF PRBG 1.9 PLTD	---	---	1133724	1133724
20/20	ROLLER, 25-5/8BF ITR 1.9 PLTD PRBG	---	---	1155256	1155256
20/21	ROLLER, 26-3/4BF ITR 1.9 PLTD PRBG	---	---	1154745	1154745
20/22	ROLLER, ITR 27-15/16" BF PRBG 1.9 PLTD	---	---	---	1133726
20/23	ROLLER, 29-1/16BF ITR 1.9 PLTD PRBG	---	---	---	1155257
20/24	ROLLER, 30-1/4BF ITR 1.9 PLTD PRBG	---	---	---	1155258
20/25	ROLLER, ITR 31-3/8" BF PRBG 1.9 PLTD	---	---	---	1133728
20/26	ROLLER, 32-1/2BF ITR 1.9 PLTD PRBG	---	---	---	1155259
20	ROLLER, _ ITR 1.9 PLTD PRBG 1D1S (_ BF)	E0002422	E0002423	E0002424	1198370
21	ROLLER, _ ITR 1.9" DIA PLTD (_ BF)	E0002412	E0002413	E0002414	E0006220
22	ROLLER, ITR 13.25BF 2G ITOH PM486FE-60	---	---	1165293	1165293
23	ROLLER, ITR SPUR 2G ITOH (2" GROOVE SPACING)	1171592	1171592	1171592	1171592
23	ROLLER, _ ITR 1.9PLTD PRBG 1D1S (_ BF)	---	---	1198370	1198370

Ref Dwg# 130A559

18.41 ITR WHEEL DIVERTER (PNEUMATIC LIFT)

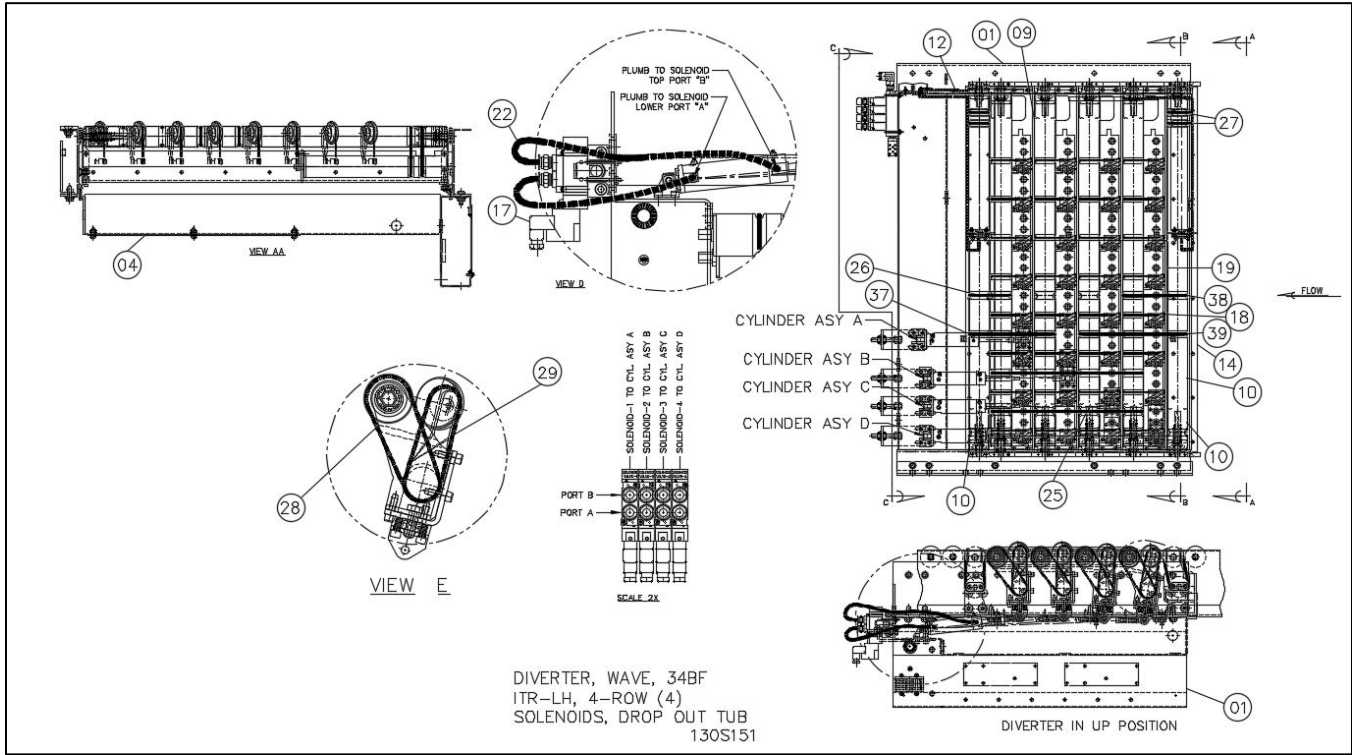

18.41.1 Replacement Parts - ITR Wheel Diverter (Pneumatic Lift)

REPLACEMENT PARTS - ITR WHEEL DIVERT (PNEUMATIC) CB OR IBE, 2RC & 3RC, 30 DEGREES					
WD,ITR-_BF-CB OR IBE-C6-2RC OR 3RC-30D LH/RH-FE60-_MR-_SOL-W/DROPOUT					
Balloon	DESCRIPTION	16 BF	22 BF	28 BF	34 BF
---	DIVERTER WAVE	---	---	---	---
01	CYL,AIR,1" BORE, 2" STROKE AD	1109080	1109080	1109080	1109080
02	WHEEL,ASY NBS30 (MOLDED TIRE) ALUMINUM	1158076	1158076	1158076	1158076
04	WHEEL,ASY IDLER NBS30 ALUMINUM	1158077	1158077	1158077	1158077
09	ROLLER,WD _BF ITR PRBG DROP OUT TUB	1195066	1191359	1194883	1198388
10	ROLLER,WD _BF ITR PRBG,5 GRV DROP OUT TUB	1195067	1191372	1194884	1198402
---	ROLLER,ASY ITR - HEX FLAT UP GROOVES	---	---	---	---
11/03	ROLLER,ITR 13.25BF 2G ITOHPM486FE-60 (USED W/IBE)	1198348	1198348	1198348	1198348
11/03	ROLLER,ITR 13.25BF 2G ITOH PM486FE-60 (USED W/CB OR HB)	1191381	1191381	1191381	1191381
12	CABLE,MOTOR EXTENSION 600MM ITOH M-F-EXT-10PIN-600	REFERENCE CABLE, MOTOR EXTENSION USED WITH STATED DRIVER CARD			
22	TUBING,1/4"POLYU-95DURO.160ID	E0001391	E0001391	E0001391	E0001391
25	ORING,83A WD 3/16 X 25-3/8	1141505	1141505	1141505	1141505
26	ORING,3/16DIA X 7-3/4" HT BLUE ITR 2"CTR	1142656	1142656	1142656	1142656
27	ORING,.210 DIA X 9.1" HT RED ITR 2.75"CTR	1172694	1172694	1172694	1172694
28	ORING,83A 1/8" X 10"	1141229	1141229	1141229	1141229
29	ORING,83A 1/8 X 9-1/4" BLACK	E0001239	E0001239	E0001239	E0001239
37	ORING,3/16DIA X 14.5" HT BLUE 6" CTR	1172695	1172695	1172695	1172695
38	ORING,3/16DIA X 11" HT BLUE ITR 4"CTR	1127703	1127703	1127703	1127703
39	ORING,3/16DIA X 17.95" HT BLUE 8" CTR	1172696	1172696	1172696	1172696

Ref Dwg# 130S151

18.42 ITR WHEEL DIVERT (ELECTRIC LIFT)

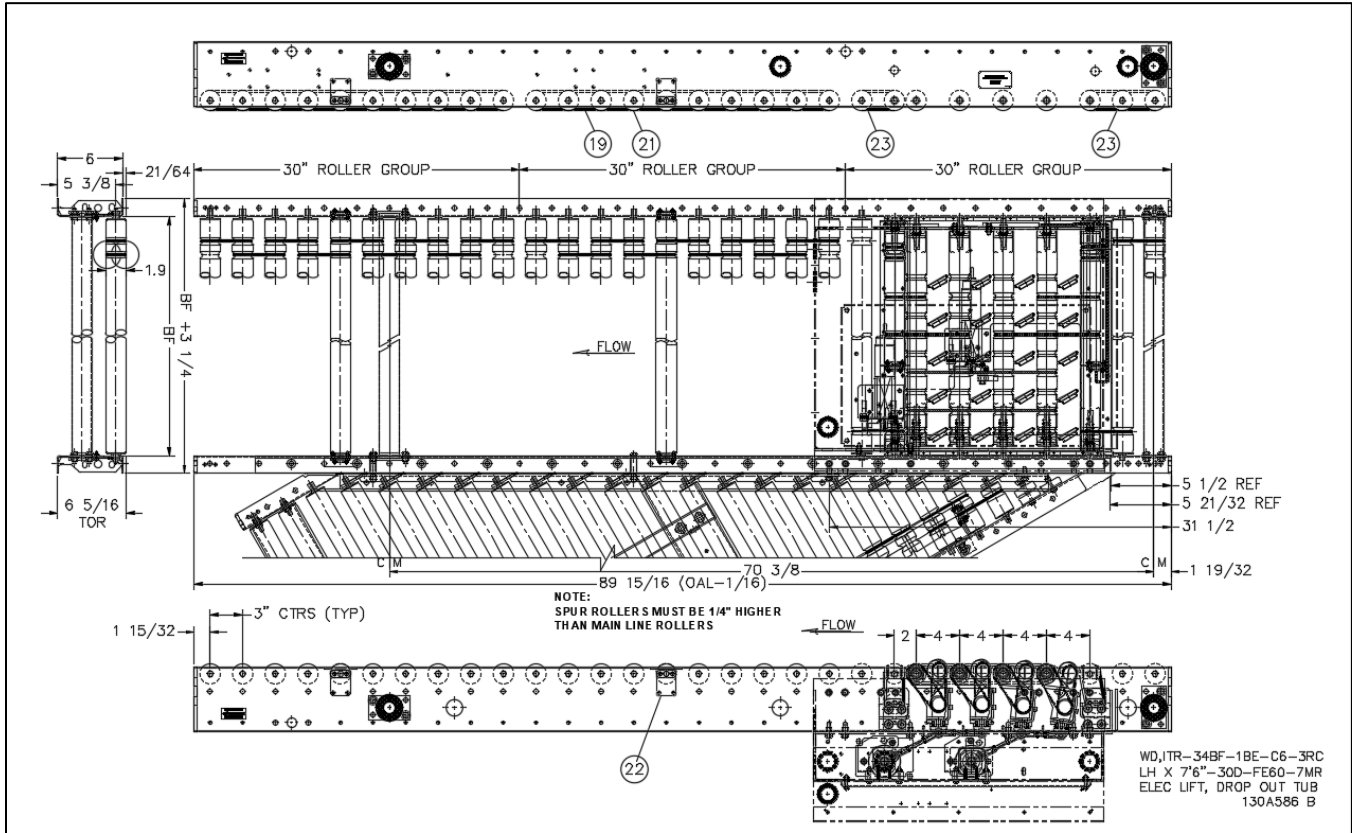

18.42.1 Replacement Parts – ITR Wheel Divert, IB-E03, 3RC (Electric Lift)

REPLACEMENT PARTS - ITR WHEEL DIVERT ELECTRIC LIFT, IB-E, 3RC, 30 DEGREES					
WD,ITR,_BF-IBE-C6-3RC-30D-LH/RH-FE60-MR-ELIFT-W/DROPOUT	Width & Item #				
Balloon	Description	16 BF	22 BF	28 BF	34 BF
---	ELECTRICAL COMPONENTS	---	---	---	---
04	DRIVERCARD, ITOH IB-E03BP	1166286	1166286	1166286	1166286
---	CONNECTOR, IDC SCOTCH LOK 567 - BROWN	3M567	3M567	3M567	3M567
---	CONN, WAGO 231-302/026-000	1162204	1162204	1162204	1162204
---	CONNECTOR, IDC SCOTCHLOK 562 - YELLOW	3M562	3M562	3M562	3M562
---	CABLE, MOTOR EXTENSION, 600,1200,OR 2700 MM LONG	REFERENCE CABLE, MOTOR EXTENSION USED WITH STATED DRIVER CARD			
---	CABLE, CTRLS-CAT5E-_-GRAY	REFERENCE Cat5E COMMUNICATION CABLE			
----	DIVERTER, WAVE	----	----	----	----
2	WHEEL, ASY NBS30 (MOLDED TIRE) ALUMINUM	1158076	1158076	1158076	1158076
4	WHEEL, ASY IDLER NBS30 ALUMINUM	1158077	1158077	1158077	1158077
3	CONN, 2 COND, W/LEVERS 24 - 12 AWG	1185928	1185928	1185928	1185928
6	PCB, DB, PE, 4A8 STATION	1138197	1138197	1138197	1138197
8	CAM, DRIVE, WD ELEC LIFT	1200657	1200657	1200657	1200657
9	ROLLER, WD _BF ITR PRBG DROP OUT TUB PRBG 6203 BRG	1195066	1191359	1194883	1198388
10	ROLLER, WD _BF ITR PRBG, 5 GRV DROP OUT TUB PRBG 6203 BRG	1195067	1191372	1194884	1198402
21	FUSE, 4A, 125V CARTRIDGE	1102221	1102221	1102221	1102221
22	FUSE, HOLDER IN-LINE, CARTRIDGE	1102222	1102222	1102222	1102222
25	ORING, 83A WD 3/16 X 25-3/8"	1141505	1141505	1141505	1141505
27	ORING, .210 DIA X 9.1" HT RED ITR 2.75" CTR	1172694	1172694	1172694	1172694
28	ORING, 83A 1/8" X 10"	1141229	1141229	1141229	1141229
29	ORING, 83A 1/8 X 9-1/4" BLACK	E0001239	E0001239	E0001239	E0001239
32	SWITCH, PROX, 12MM DIA	1184770	1184770	1184770	1184770
37	ORING, 3/16 DIA X 14.5" HT BLUE 6" CTR	1172695	1172695	1172695	1172695
38	ORING, 3/16 DIA X 11" HT BLUE ITR 4" CTR	1127703	1127703	1127703	1127703
39	ORING, 3/16 DIA X 17.95" HT BLUE 8" CTR	1172696	1172696	1172696	1172696
41	CABLE, M12 TO WAGO 733-103, 3M FEMALE M12	1198538	1198538	1198538	1198538
46	ORING, 3/16 DIA X 7-3/4" HT BLUE ITR 2" CTR	1142656	1142656	1142656	1142656
47	TERM, BLOCK, 2-COND, 20-10AWG600V, 30A, GRAY, 6.2mm	1145413	1145413	1145413	1145413
48	TERM, SEPARATOR, ORANGE, 2mm	1180509	1180509	1180509	1180509
49	TERM, END BARRIER, GRAY, 1mm	1145415	1145415	1145415	1145415
54	DRIVERCARD, INSIGHT EZ24 HTBS HIGH TORQUE PULSE ROLLER	1173108	1173108	1173108	1173108
52	DRIVE, KYOWA 24VDC PULSE GEAR PULSE ROLLER	1177986	1177986	1177986	1177986
---	SPUR, O-RINGS	---	---	---	---
17 & 19	ORING, 3/16 DIA X 9.5" HT BLUE ITR 3" CTR	---	---	E0005536	E0005536
18	ORING, 3/16" DIA X 15.312" HT BLUE FOR ITR 6.5" CTRS (20% STRETCH)	1167247	1167247	1167247	1167247
----	ROLLER SET-3RC-30D-SPUR	----	----	----	----
20/1	ROLLER, ITR 3-3/8" BF PRBG NO AXLE	1143249	1143249	1143249	1143249
20/2	ROLLER, ITR 5-1/8" BF PRBG NO AXLE	1130836	1130836	1130836	1130836
20/3	ROLLER, 6-27/32BF ITR 1.9 PLTD PRBG	1131620	1131620	1131620	1131620
20/4	ROLLER, 8-9/16BF ITR 1.9 PLTD PRBG	1131621	1131621	1131621	1131621
20/5	ROLLER, 10-5/16BF ITR 1.9 PLTD PRBG	1143250	1143250	1143250	1143250
20/6	ROLLER, 12-1/32BF ITR 1.9 PLTD PRBG	1131622	1131622	1131622	1131622
20/7	ROLLER, 13-25/32BF ITR 1.9 PLTD PRBG	1131623	1131623	1131623	1131623
20/8	ROLLER, 15-1/2BF ITR 1.9 PLTD PRBG	---	1131624	1131624	1131624
20/9	ROLLER, 17-1/4BF ITR 1.9 PLTD PRBG	---	1143251	1143251	1143251
20/10	ROLLER, 18-31/32BF ITR 1.9 PLTD PRBG	---	1131625	1131625	1131625
20/11	ROLLER, 20-11/16BF ITR 1.9 PLTD PRBG	---	1143252	1143252	1143252
20/12	ROLLER, 22-7/16BF ITR 1.9 PLTD PRBG	---	---	1131627	1131627
20/13	ROLLER, 24-5/32BF ITR 1.9 PLTD PRBG	---	---	1131628	1131628
20/14	ROLLER, 25-29/32BF ITR 1.9 PLTD PRBG	---	---	1131629	1131629
20/15	ROLLER, 27-5/8BF ITR 1.9 PLTD PRBG	---	---	---	1140043
20/16	ROLLER, 29-3/8BF ITR 1.9 PLTD PRBG	---	---	---	1140044
20/17	ROLLER, 31-3/32BF ITR 1.9 PLTD PRBG	---	---	---	1140045
20/18	ROLLER, 32-13/16BF ITR 1.9 PLTD PRBG	---	---	---	1140046
21	ROLLER, _ITR 1.9" DIA PLTD (_BF)	E0002422	E0002413	E0002414	E0006220
22	ROLLER, ITR _BF 2G ITOH PM486FE-60	1163471	1163472	1163473	1163474
23	ROLLER, _ITR 1.9PLTD PRBG 1D1S (_BF)	E0002412	E0002423	E0002424	1198370
23	ROLLER, ITR SPUR 2G ITOH PM 486 FE-60 (3" GROOVE SPACING)	1165292	1165292	1165292	1165292
22	ROLLER, ITR 13.25BF 2G ITOH PM486FE-60	---	---	1165293	1165293
3	ROLLER, ITR 13.25BF 2G ITOHPM486FE-60	1198348	1198348	1198348	1198348

REF DWG# 130A586

18.42.2 Replacement Parts – ITR Wheel Divert, IB-E03, 2RC (Electric Lift)

REPLACEMENT PARTS - ITR WHEEL DIVERT ELECTRIC LIFT, IB-E03, 2RC,30 DEGREES					
WD,ITR_	BF-IBE-C6-2RC-30D-LH/RH-FE60_	MR-ELIFT-W/DROPOUT	Width & Item #		
Balloon	Description	16 BF	22 BF	28 BF	34 BF
ELECTRICAL COMPONENTS					
04	DRIVERCARD, ITOH IB-E03BP	1166286	1166286	1166286	1166286
---	CONNECTOR, IDC SCOTCH LOK 567 - BROWN	3M567	3M567	3M567	3M567
---	CONN, WAGO 231-302/028-000	1162204	1162204	1162204	1162204
---	CONNECTOR, IDC SCOTCHLOK 562 - YELLOW	3M562	3M562	3M562	3M562
---	CABLE, MOTOR EXTENSION, 600, 1200, OR 2700 MM LONG	REFERENCE CABLE, MOTOR EXTENSION USED WITH STATED DRIVER CARD			
---	CABLE, CTRLS-CAT5E_ _-GRAY	REFERENCE Cat5E COMMUNICATION CABLE			
---	HARNESS, POWER BROWN & BLUE (NOT BF SPECIFIC)	3'-0" L 1102289	5'-5" L 1102288	8'-0" L 1102287	10'-6" L 1102286
3	CONN, 2 COND, W/LEVERS 24 - 12 AWG	1185928	1185928	1185928	1185928
6	PCB, DB, PE, 4A8 STATION	1138197	1138197	1138197	1138197
8	CAM, DRIVE, WD ELEC LIFT	1200657	1200657	1200657	1200657
9	ROLLER, WD _BF ITR PRBG DROP OUT TUB	1195066	1191359	1194883	1198388
10	PRBG 6203 BRG	1195067	1191372	1194884	1198402
18	ORING, 3/16 DIA X 8-1/4" HT BLUE	E0034023	E0034023	E0034023	E0034023
---	DIVERTER WAVE	---	---	---	---
2	WHEEL, ASY NBS30 (MOLDED TIRE) ALUMINUM	1158076	1158076	1158076	1158076
4	WHEEL, ASY IDLER NBS30 ALUMINUM	1158077	1158077	1158077	1158077
21	FUSE, 4A, 125V CARTRIDGE	1102221	1102221	1102221	1102221
22	FUSE, HOLDER IN-LINE, CARTRIDGE	1102222	1102222	1102222	1102222
25	ORING, 83A WD 3/16 X 25-3/8"	1141505	1141505	1141505	1141505
27	ORING, 210 DIA X 9.1" HT REDITR 2.75" CTR	1172694	1172694	1172694	1172694
28	ORING, 83A 1/8" X 10"	1141229	1141229	1141229	1141229
29	ORING, 83A 1/8 X 9-1/4" BLACK	E0001239	E0001239	E0001239	E0001239
32	SWITCH, PROX, 12MM DIA, FLUSH MT4MM RANGE, M12 4-PIN CONN PNP	1184770	1184770	1184770	1184770
37	ORING, 3/16 DIA X 14.5" HT BLUE 6" CTR	1172695	1172695	1172695	1172695
38	ORING, 3/16 DIA X 11" HT BLUE ITR 4" CTR	1127703	1127703	1127703	1127703
39	ORING, 3/16 DIA X 17.95" HT BLUE 8" CTR	1172696	1172696	1172696	1172696
41	CABLE, M12 TO WAGO 733-103, 3M FEMALE M12	1198538	1198538	1198538	1198538
46	ORING, 3/16 DIA X 7-3/4" HT BLUE ITR 2" CTR	1142656	1142656	1142656	1142656
47	TERM, BLOCK, 2-COND, 20-10AWG600V, 30A, GRAY, 6.2mm	1145413	1145413	1145413	1145413
48	TERM, SEPARATOR, ORANGE, 2mm	1180509	1180509	1180509	1180509
49	TERM, END BARRIER, GRAY, 1mm	1145415	1145415	1145415	1145415
52	DRIVE, KYOWA 24VDC PULSE GEAR PULSE ROLLER	1177986	1177986	1177986	1177986
54	DRIVERCARD, INSIGHT E224HTBS HIGH TORQUE PULSE ROLLER	1173108	1173108	1173108	1173108
---	SPUR, O-RINGS	---	---	---	---
17	ORING, 3/16 DIA X 9.5" HT BLUE ITR 3" CTR	---	---	E0005536	E0005536
18	ORING, 3/16" DIA X 15.312" HT BLUE FOR ITR 6.5" CTRS (20% STRETCH)	1167247	1167247	1167247	1167247
19	ORING, 3/16 DIA X 7-3/4" HT BLUE ITR 2" CTR	1142656	1142656	1142656	1142656
---	ROLLER SET-2RC-30D-SPUR	---	---	---	---
20/1	ROLLER, ITR 3-11/16" BF PRBG (NO AXLE) 1 GROOVE	1152360	1152360	1152360	1152360
20/2	ROLLER, ITR 4-3/4" BF PRBG NO AXLE	E0003268	E0003268	E0003268	E0003268
20/3	ROLLER, 6BF ITR 1.9 PLTD PRBG	1152260	1152260	1152260	1152260
20/4	ROLLER, 7-1/8BF ITR 1.9 PLTD PRBG	1152261	1152261	1152261	1152261
20/5	ROLLER, 8-5/16BF ITR 1.9 PLTD PRBG	1152262	1152262	1152262	1152262
20/6	ROLLER, 9-7/16BF ITR 1.9 PLTD PRBG	1152263	1152263	1152263	1152263
20/7	ROLLER, 10-5/8BF ITR 1.9 PLTD PRBG	1152264	1152264	1152264	1152264
20/8	ROLLER, 11-3/4BF ITR 1.9 PLTD PRBG	1152265	1152265	1152265	1152265
20/9	ROLLER, 12-15/16BF ITR 1.9 PLTD PRBG	1152266	1152266	1152266	1152266
20/10	ROLLER, 14-1/16BF ITR 1.9 PLTD PRBG	1152268	1152268	1152268	1152268
20/11	ROLLER, 15-3/16BF ITR 1.9 PLTD PRBG	1152269	1152269	1152269	1152269
20/12	ROLLER, 16-3/8BF ITR 1.9 PLTD PRBG	---	1152254	1152254	1152254
20/13	ROLLER, ITR 17-1/2" BF 1.9 PLTD PRBG	---	1133722	1133722	1133722
20/14	ROLLER, 18-3/4BF ITR 1.9 PLTD PRBG	---	1154742	1154742	1154742
20/15	ROLLER, 19-3/4BF ITR 1.9 PLTD PRBG	---	1144374	1144374	1144374
20/16	ROLLER, ITR 21" BF 1.9 PLTD PRBG	---	1133723	1133723	1133723
20/17	ROLLER, 22-3/16BF ITR 1.9 PLTD PRBG	---	---	1152255	1152255
20/18	ROLLER, ITR 23-1/4" BF PRBG	---	---	1131992	1131992
20/19	ROLLER, ITR 24-7/16" BF PRBG, 1.9 PLTD	---	---	1133724	1133724
20/20	ROLLER, 25-5/8BF ITR 1.9 PLTD PRBG	---	---	1152256	1152256
20/21	ROLLER, 26-3/4BF ITR 1.9 PLTD PRBG	---	---	1154745	1154745
20/22	ROLLER, ITR 27-15/16" BF PRBG, 1.9 PLTD	---	---	---	1133726
20/23	ROLLER, 29-1/16BF ITR 1.9 PLTD PRBG	---	---	---	1152257
20/24	ROLLER, 30-1/4BF ITR 1.9 PLTD PRBG	---	---	---	1152258
20/25	ROLLER, ITR 31-3/8" BF PRBG 1.9 PLTD	---	---	---	1133728
20/26	ROLLER, 32-1/2BF ITR 1.9 PLTD PRBG	---	---	---	1152259
21	ROLLER, _ITR 1.9" DIA PLTD (_BF)	E0002412	E0002413	E0002414	E0006220
22	ROLLER, ITR _BF 2G ITOH PM486FE-60 (USED W/ IBE)	1163471	1163472	1163473	1163474
22	ROLLER, ITR 13.25BF 2G ITOH PM486FE-60	---	---	1165293	1165293
3	ROLLER, ITR 13.25BF 2G ITOH PM486FE-60	1198348	1198348	1198348	1198348
23	ROLLER, _ITR 1.9PLTD PRBG 1D1S (_BF)	E0002422	E0002423	E0002424	1198370
3	ROLLER, ITR SPUR 2G ITOH, 2 CPM 486 FE-60 (2" GROOVE SPACING)	1171592	1171592	1171592	1171592

REF DWG# 130A588

18.43 ITR WHEEL DIVERTER (ELECTRIC LIFT)

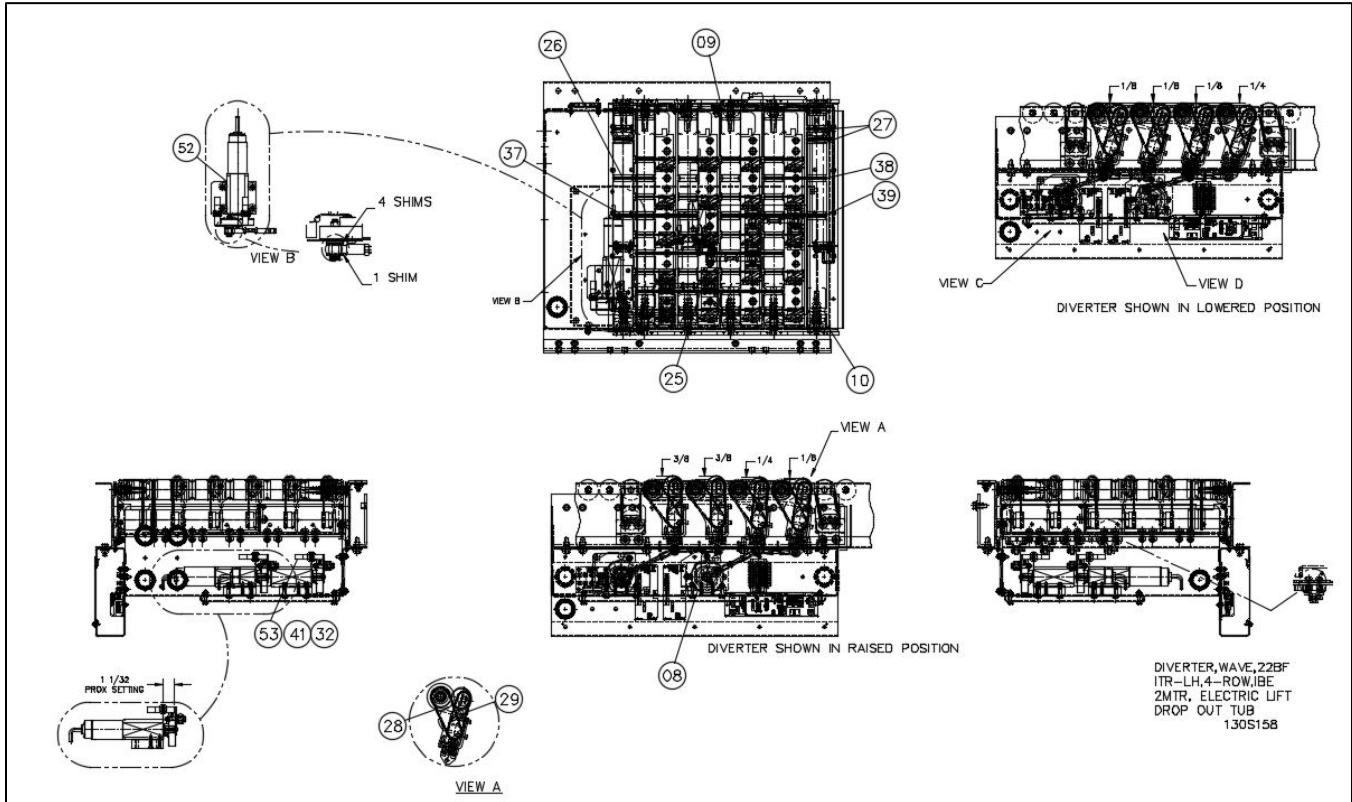

18.43.1 Replacement Parts – ITR Wheel Diverter (Electric Lift) Components

REPLACEMENT PARTS - ITR WHEEL DIVERTER 24V ELECTRIC LIFT COMPONENTS					
Balloon	Description	Width & Item #			
		16 BF	22 BF	28 BF	34 BF
---	WHEEL,ASY NBS30 (MOLDED TIRE) ALUMINUM	1158076	1158076	1158076	1158076
---	WHEEL,ASY IDLER NBS30 ALUMINUM	1158077	1158077	1158077	1158077
---	ROLLER,ITR 13.25BF 2G ITOHPM486FE-60	1198348	1198348	1198348	1198348
08	CAM,DRIVE,WD	1200657	1200657	1200657	1200657
09	ROLLER,WD __BF ITR PRBG	1191359	1191359	1191359	1191359
10	ROLLER,WD __BF ITR PRBG	1191372	1191372	1191372	1191372
25	ORING,83A WD 3/16 X 25-3/8"	1141505	1141505	1141505	1141505
26	ORING,3/16 DIA X 7-3/4" HT BLUE ITR 2"CTR	1142656	1142656	1142656	1142656
27	ORING,.210 DIA X 9.1" HT RED	1172694	1172694	1172694	1172694
28	ORING,83A 1/8" X 10"	1141229	1141229	1141229	1141229
29	ORING,83A 1/8 X 9-1/4" BLACK	E0001239	E0001239	E0001239	E0001239
32	SWITCH,PROX,12MM DIA,FLUSH MT PNP	1184770	1184770	1184770	1184770
37	ORING,3/16 DIA X 14.5" HT BLUE	1172695	1172695	1172695	1172695
38	ORING,3/16 DIA X 11" HT BLUE	1127703	1127703	1127703	1127703
39	ORING,3/16 DIA X 17.95" HT BLUE	1172696	1172696	1172696	1172696
41	CABLE,M12 TO WAGO 733-103,3M FEMALE M12	1198538	1198538	1198538	1198538
52	DRIVE,KYOWA 24VDC PULSE GEAR PULSE ROLLER	1177986	1177986	1177986	1177986

Ref Dwg# 130S158

18.44 ITR WHEEL DIVERTER (ELECTRIC LIFT) - ELECTRICAL COMPONENTS

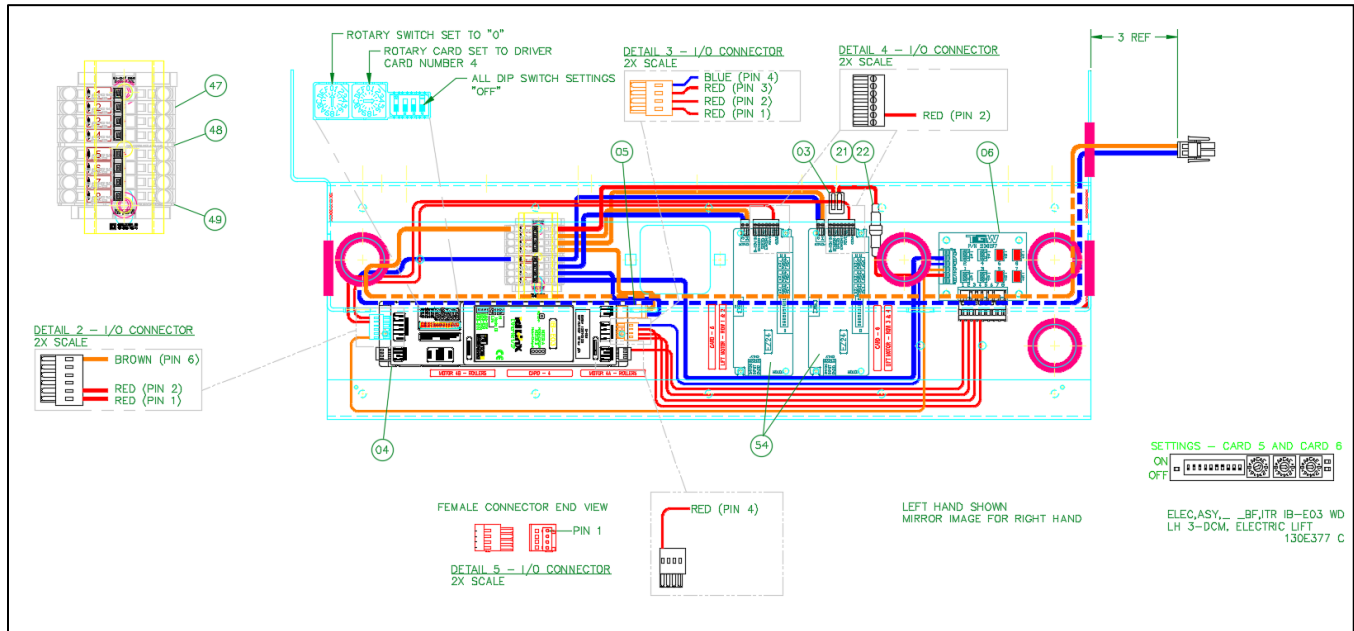

18.44.1 Replacement Parts – ITR Wheel Diverter (Electric Lift) – Electrical Components

REPLACEMENT PARTS - ITR WHEEL DIVERT ELECTRIC LIFT, ELECTRICAL COMPONENTS					
Balloon	Description	Width & Item #			
		16 BF	22 BF	28 BF	34 BF
3	CONN,2 COND,W/LEVERS24 - 12 AWG	1185928	1185928	1185928	1185928
4	DRIVERCARD,ITOH IB-E03BP	1166286	1166286	1166286	1166286
5	CONN,WAGO 231-302/026-000	1162204	1162204	1162204	1162204
6	PCB,DB,PE,4A8 STATION	1138197	1138197	1138197	1138197
21	FUSE,4A,125V CARTRIDGE	1102221	1102221	1102221	1102221
22	FUSE,HOLDER IN-LINE,CARTRIDGE	1102222	1102222	1102222	1102222
47	TERM,BLOCK,2-COND,20-10AWG600V,30A,GRAY,6.2mm	1145413	1145413	1145413	1145413
48	TERM,SEPARATOR,ORANGE,2mm	1180509	1180509	1180509	1180509
49	TERM,END BARRIER,GRAY,1mm	1145415	1145415	1145415	1145415
54	DRIVERCARD,INSIGHT EZ24 HTBS HIGH TORQUE PULSE ROLLER	1173108	1173108	1173108	1173108

Ref Dwg# 130E377

18.45 ITR UBT (PNEUMATIC LIFT) - MECHANICAL COMPONENTS 5s & 6s

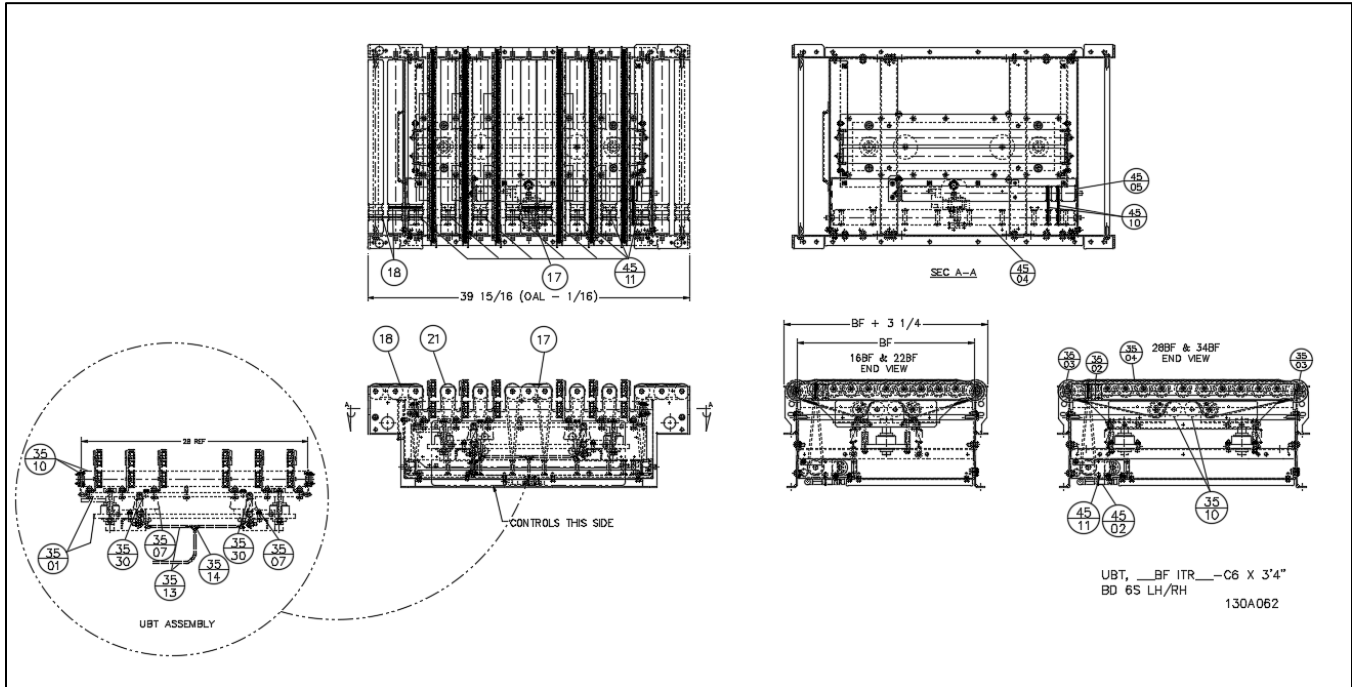

18.45.1 Replacement Parts – ITR UBT (Pneumatic Lift) - Mechanical Components CB, 5s & 6s

REPLACEMENT PARTS - ITR UBT PNEUMATIC LIFT, BI-DIRECTIONAL, CB, 5s or 6s					
Balloon	Description	Width & Item #			
		16 BF	22 BF	28 BF	34 BF
----	UBT,MECH _ _BF ITR UBT	----	----	----	----
17	ORING,3/16 DIA X7-3/4" HT BLUE ITR 2"CTR	1142656	1142656	1142656	1142656
18	ORING,3/16 DIA X8.688 HT BLUE	1137420	1137420	1137420	1137420
21	ROLLER,_ ITR 1.9 PLTD PRBG (_ _BF)	E0002412	E0002413	E0002414	E0006220
35/01	LIFT TABLE,ASY A&B ITR2 UBT,36"PER PRINT (5s)	1154634	1154634	1159922	1159922
35/01	LIFT TABLE,ASY A&B ITR2 UBT,36"PER PRINT (6s)	1132815	1132815	1141051	1141051
35/07	AIRBAG,FIRESTONE	90000025	90000025	90000025	90000025
35/13	TUBING,1/4"POLY U-95 DURO.160ID	E0005539	E0005539	E0005539	E0005539
35/14	TEE,UNION BARBED 1/4" TO 1/4"H	89000520	89000520	89000520	89000520
35/10	ROLLER,ITR 24BF NG ITOH-PM486FP-55-595-D-24-JR-KF-JR HEX SHAFT (5s)(CB)	1215120	1215120	1215120	1215120
35/10	ROLLER,ITR 28BF NG ITOH PM486FP-55-696-D-24-JR-KF JR HEX SHAFT (6s) (CB)	1143813	1143813	1143813	1143813
35/30	SPRING,EXT 3/4OD X2" LG .075W LOOPS MUST BE INLINE +/- 20	90800263	90800263	90800263	90800263
----	WHEELBRKT,ASY ITR UBT _ _BF	----	----	----	----
35/02	IDLER,ASY FLAT FACE ITR UBT	1132379	1132379	1132379	1132379
35/03	IDLER,ASY FLANGED ITR UBT	1159961	1159961	1159961	1159961
35/04	BELT,83A .188 X .468 X 66" _ _BF ITR2 UBT	1132754	1132755	1132756	1132757
----	PAN,ASY BOTTOM ITR	----	----	----	----
45/02	VALVE,SMC 4WAY 24VDC W/FITT &3M CABLE,ITR UBT/ERS	1139102	1139102	1139102	1139102
45/04	ROLLER,CARRIER DRIVEITR2 UBT 4"C,36" LG UBT (5s)	1154791	1154791	1154791	1154791
45/04	ROLLER,CARRIER DRIVEITR2 UBT 4"C,36" LG UBT (6s)	1132730	1132730	1132730	1132730
45/05	ROLLER,ITR _ _BF 2G ITOH PM486FE-60 (5s)	1138722	1138722	1138722	1138722
45/05	ROLLER,ITR _ _BF 2G ITOH PM 486 FE-60 - (6s)	1138723	1138723	1138723	1138723
45/10	ORING,1/4"DIA X9.5" HT BLUE	1144848	1144848	1144848	1144848
45/11	ORING,83A ST TRNS 3/16X21-3/8	1149850	1149850	1149850	1149850

Reference Dwg: 130A062

18.45.2 Replacement Parts – ITR UBT (Pneumatic Lift) - Mechanical Components IBE, 5s & 6s

REPLACEMENT PARTS - ITR UBT PNEUMATIC LIFT, BI-DIRECTIONAL, IBE, 5s or 6s					
Balloon	Description	Width & Item #			
		16 BF	22 BF	28 BF	34 BF
----	UBT,MECH __BF ITR UBT	----	----	----	----
17	ORING,3/16 DIA X 7-3/4" HT BLUE ITR 2"CTR	1142656	1142656	1142656	1142656
18	ORING,3/16 DIA X 8.688 HT BLUE	1137420	1137420	1137420	1137420
21	ROLLER,__ITR 1.9 PLTD PRBG (__BF)	E0002412	E0002413	E0002414	E0006220
35/01	LIFT TABLE,ASY A&B ITR2 UBT,36"PER PRINT (5s)	1154634	1154634	1159922	1159922
35/01	LIFT TABLE,ASY A&B ITR2 UBT,36"PER PRINT (6s)	1132815	1132815	1141051	1141051
35/07	AIRBAG, FIRESTONE	90000025	90000025	90000025	90000025
35/13	TUBING,1/4"POLY U-95 DURO.160ID	E0005539	E0005539	E0005539	E0005539
35/14	TEE,UNION BARBED 1/4" TO 1/4"H	89000520	89000520	89000520	89000520
35/10	ROLLER,ITR 24BF NG ITOH-PM486FP-55-595-D-24-JR-Z060-KF-JR HEX SHAFT,600MM CABLE W/ 10 PIN CONN (5s) (IBE)	1215122	1215122	1215122	1215122
35/10	ROLLER,ITR 28BF NG ITOH PM486FP-55-696-D-24-JR-Z060-KF JR HEX SHAFT,600MM CABLE W/ 10 PIN CONN (6s) (IBE)	1167000	1167000	1167000	1167000
35/30	SPRING,EXT 3/4OD X 2" LG .075W LOOPS MUST BE INLINE +/- 20	90800263	90800263	90800263	90800263
----	WHEELBRKT,ASY ITR UBT __BF	----	----	----	----
35/02	IDLER,ASY FLAT FACE ITR UBT	1132379	1132379	1132379	1132379
35/03	IDLER,ASY FLANGED ITR UBT	1159961	1159961	1159961	1159961
35/04	BELT,83A .188 X .468 X 66"__BF ITR2 UBT	1132754	1132755	1132756	1132757
----	PAN,ASY BOTTOM ITR	----	----	----	----
45/02	VALVE,SMC 4WAY 24VDC W/FITT &3M CABLE,ITR UBT/ERS	1139102	1139102	1139102	1139102
45/04	ROLLER,CARRIER DRIVEITR2 UBT 4"C,36" LG UBT (5s)	1154791	1154791	1154791	1154791
45/04	ROLLER,CARRIER DRIVEITR2 UBT 4"C,36" LG UBT (6s)	1132730	1132730	1132730	1132730
45/05	ROLLER,ITR __BF 2G ITOH PM486FE-60 (5s)	1163471	1163471	1163471	1163471
45/05	ROLLER,ITR __BF 2G ITOH PM 486 FE-60 - (6s)	1163472	1163472	1163472	1163472
45/10	ORING,1/4"DIA X 9.5" HT BLUE	1144848	1144848	1144848	1144848
45/11	ORING,83A ST TRNS 3/16X21-3/8	1149850	1149850	1149850	1149850

Reference Dwg: 130A062

18.46 ITR UBT (PNEUMATIC LIFT) - ELECTRICAL COMPONENTS CB, 5s & 6s

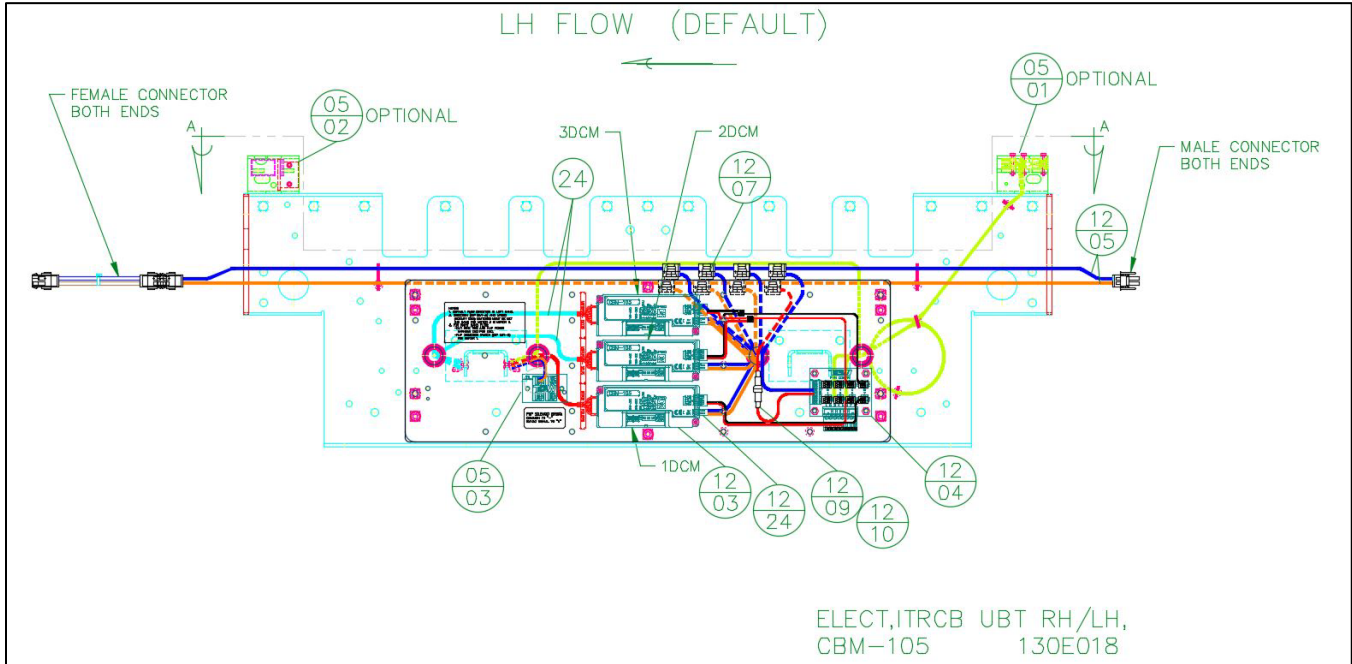

18.46.1 Replacement Parts - ITR UBT (Pneumatic Lift) - Electrical Components CB, 5s & 6s

REPLACEMENT PARTS - ITR UBT PNEUMATIC, ELECTRICAL COMPONENTS, CB, 5s & 6s					
Balloon	Description	Width & Item #			
		16 BF	22 BF	28 BF	34 BF
---	ELECTRICAL COMPONENTS	---	---	---	---
24	CABLE, MOTOR EXTENSION, 600, 1200, OR 2700 MM LONG	REFERENCE CABLE, MOTOR EXTENSION USED WITH STATED DRIVER CARD			
---	PE, ASY ITR UBT, PE AND RF	---	---	---	---
05/01	PE, REFLEX TYPE ZL, PNP, LIGHT OP, 2M CABLE	1138113	1138113	1138113	1138113
05/02	PE, REFLECTOR 20MM X 30MM ADHESIVE BACKED	1136359	1136359	1136359	1136359
05/03	PCB, DB, PE, EXTENSION (CBM-105FP)	1138198	1138198	1138198	1138198
---	PL, ASY ITR CB UBT, LH/RH CBM-105	---	---	---	---
12/03	DRIVERCARD, ITOH CBM-105FP	1153930	1153930	1153930	1153930
12/04	PCB, DB, PE, 4A8 STATION	1138197	1138197	1138197	1138197
12/07	CONNECTOR, IDC SCOTCH LOK 567 - BROWN	3M567	3M567	3M567	3M567
12/09	FUSE, HOLDER IN-LINE, CARTRIDGE	102222	102222	102222	102222
12/10	FUSE, 4A, 125V, CARTRIDGE	1102221	1102221	1102221	1102221
12/24	CONNECTOR, IDC SCOTCH LOK 558 - RED	1120174	1120174	1120174	1120174

Reference Dwg: 130E018

18.47 ITR UBT (PNEUMATIC LIFT) - ELECTRICAL COMPONENTS IB-E03, 5s & 6s

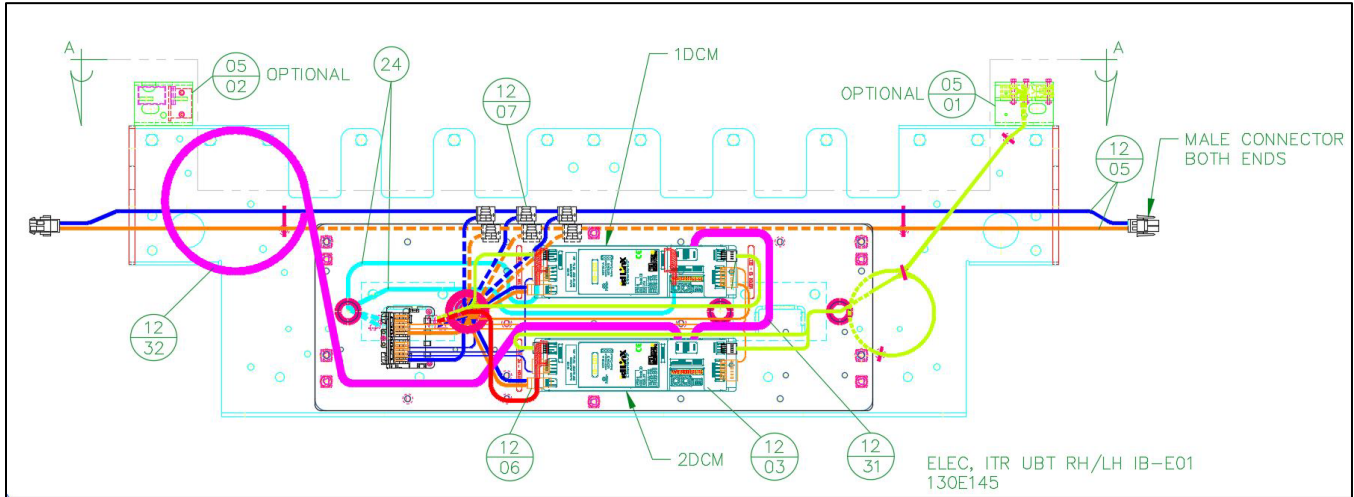

18.47.1 Replacement Parts - ITR UBT (Pneumatic Lift) - Electrical Components IB-E03 5s & 6s

REPLACEMENT PARTS - ITR UBT PNEUMATIC, ELECTRICAL COMPONENTS, IBE, 5s & 6s					
Balloon	Description	Width & Item #			
		16 BF	22 BF	28 BF	34 BF
----	ELECTRICAL COMPONENTS	----	----	----	----
24	CABLE, MOTOR EXTENSION, 600, 1200, OR 2700 MM LONG	REFERENCE CABLE, MOTOR EXTENSION USED WITH STATED DRIVER CARD			
----	PE, ASY ITR UBT		----	----	----
05/01	PE, REFLEX TYPE ZL, PNP, LIGHT OPERATE	1163456	1163456	1163456	1163456
05/02	PE, REFLECTOR 20MM X 30MM ADHESIVE BACKED	1136359	1136359	1136359	1136359
----	PL, ASY ITR CB UBT, LH/RH IB-E03	----	----	----	----
12/03	DRIVERCARD, ITOH IB-E03BP	1166286	1166286	1166286	1166286
12/06	CONN, WAGO 231-302/026-000	1162204	1162204	1162204	1162204
12/07	CONNECTOR, IDC SCOTCH LOK 567 - BROWN	3M567	3M567	3M567	3M567
---	CABLE, CTRLS-CAT5E-_-GRAY	REFERENCE Cat5E COMMUNICATION CABLE			

Reference Dwg: 130E145

18.48 ITR UBT (ELECTRIC LIFT) - MECHANICAL COMPONENTS 5s & 6s

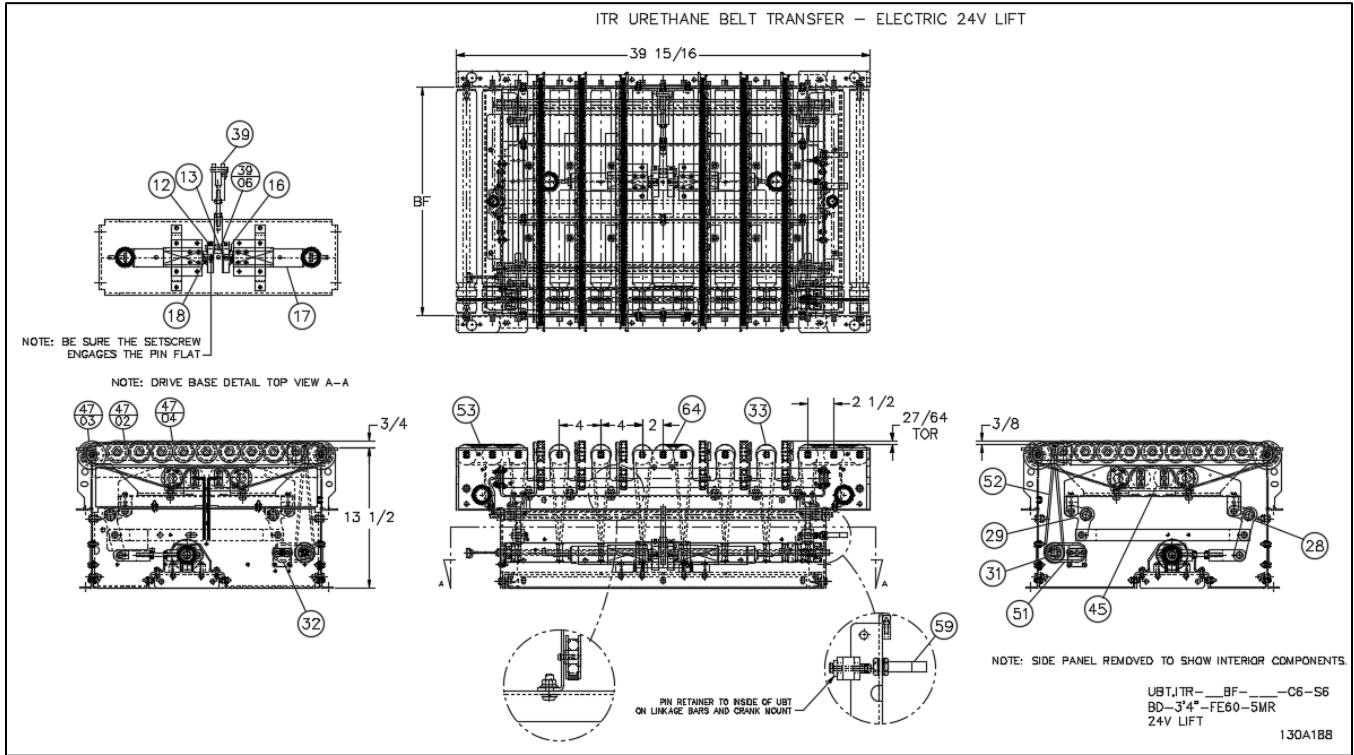

18.48.1 Replacement Parts – ITR UBT (Electric Lift) - Mechanical Components 5s & 6s

REPLACEMENT PARTS - ITR UBT (ELECTRIC LIFT), BI-DIRECTIONAL, IBE, 5S or 6S					
UBT, ITR- _BF-IBE-C6-5S OR 6S-BD-FE60- _MR-ELIFT-W/PE		Width & Item #			
Balloon	Description	16 BF	22 BF	28 BF	34 BF
12	CAM, DRIVE ELECTRIC LIFT UBT, ERS, WING BED	1196464	1196464	1196464	1196464
17	DRIVE, KYOWA 24VDC PULSE GEAR PULSE ROLLER	1177986	1177986	1177986	1177986
---	ASY, DRIVE CRANK & ASY, IDLE CRANK	---	---	---	---
28 & 29	BUSHING, BRONZE, FLANGED 3/4 X 1/2 X 1 LG, 1/8 FLNG THK	1177970	1177970	1177970	1177970
28 & 29	BUSHING, BRONZE, PLAIN 1/2 X 5/8 X 3/8 LG	1184965	1184965	1184965	1184965
31	ROLLER, CARRIER DRIVE ITR 2 UBT 4"C, 5-STRAND ELECTRIC LIFT (5S)	1196474	1196474	1196474	1196474
32	ROLLER, ITR 23BF 2G ITOH PM 486 FE-60 - (5S)	1191569	1191569	1191569	1191569
31	ROLLER, CARRIER DRIVE ITR, UBT 4"C, 6-STRAND ELECTRIC LIFT (6S)	1187651	1187651	1187651	1187651
32	ROLLER, ITR 31BF 2G ITOH PM 486 FE-60 - (6S)	1191570	1191570	1191570	1191570
33	ROLLER, _ _ ITR 1.9 PLTD PRBG ELECTRIC LIFT UBT	1196522	1196523	1196524	1196525
39	ASY, DRIVE LINKAGE ELECTRIC LIFT	1196442	1196442	1196442	1196442
---	ASY, DRIVE LINKAGE	---	---	---	---
39/06	BUSHING, BRONZE, FLANGED 3/8 X 1/2 X 3/8 LG 1/16 FLNG THK	1184963	1184963	1184963	1184963
---	ROLLER, ASY ITR _ _ BF NG	---	---	---	---
45	ROLLER, ITR 23BF NG ITOH-PM486FP-55- (5S)	1214900	1214900	1214900	1214900
45	ROLLER, ITR 31BF NG ITOH-PM486FP-55- (6S)	1215118	1215118	1215118	1215118
---	WHEEL BRKT, ASY ITR UBT _ _ "BF	---	---	---	---
47/02	IDLER, ASY FLAT FACE ITR UBT	1132379	1132379	1132379	1132379
47/03	IDLER, ASY FLANGED ITR UBT	1159961	1159961	1159961	1159961
47/04	BELT, 83A .188 X .468 X 66" _ _ BF ITR2 UBT	1132754	1132755	1132756	1132757
51	ORING, 3/16 DIA X 8-1/4" HT BLUE	E0034023	E0034023	E0034023	E0034023
52	ORING, 83A ST TRNS 3/16X21-3/8	1149850	1149850	1149850	1149850
53	ORING, 3/16 DIA X 8.688 HT BLUE	1137420	1137420	1137420	1137420
59	SWITCH, PROX, 12MM DIA, FLUSH MT4MM RANGE	1184770	1184770	1184770	1184770
64	ORING, 3/16 DIA X 7-3/4" HT BLUE ITR 2"CTR	1142656	1142656	1142656	1142656
---	CABLE, M12 TO WAGO 733-104, 2M5P FEMALE	1183766	1183766	1183766	1183766
---	CABLE, MOTOR EXTENSION, 600, 1200, OR 2700 MM LONG	REFERENCE CABLE, MOTOR EXTENSION USED WITH STATED DRIVER CARD			

Reference Dwg: 130A188

18.49 ITR UBT, (ELECTRIC LIFT) - ELECTRICAL COMPONENTS IB-E03, 5s & 6s

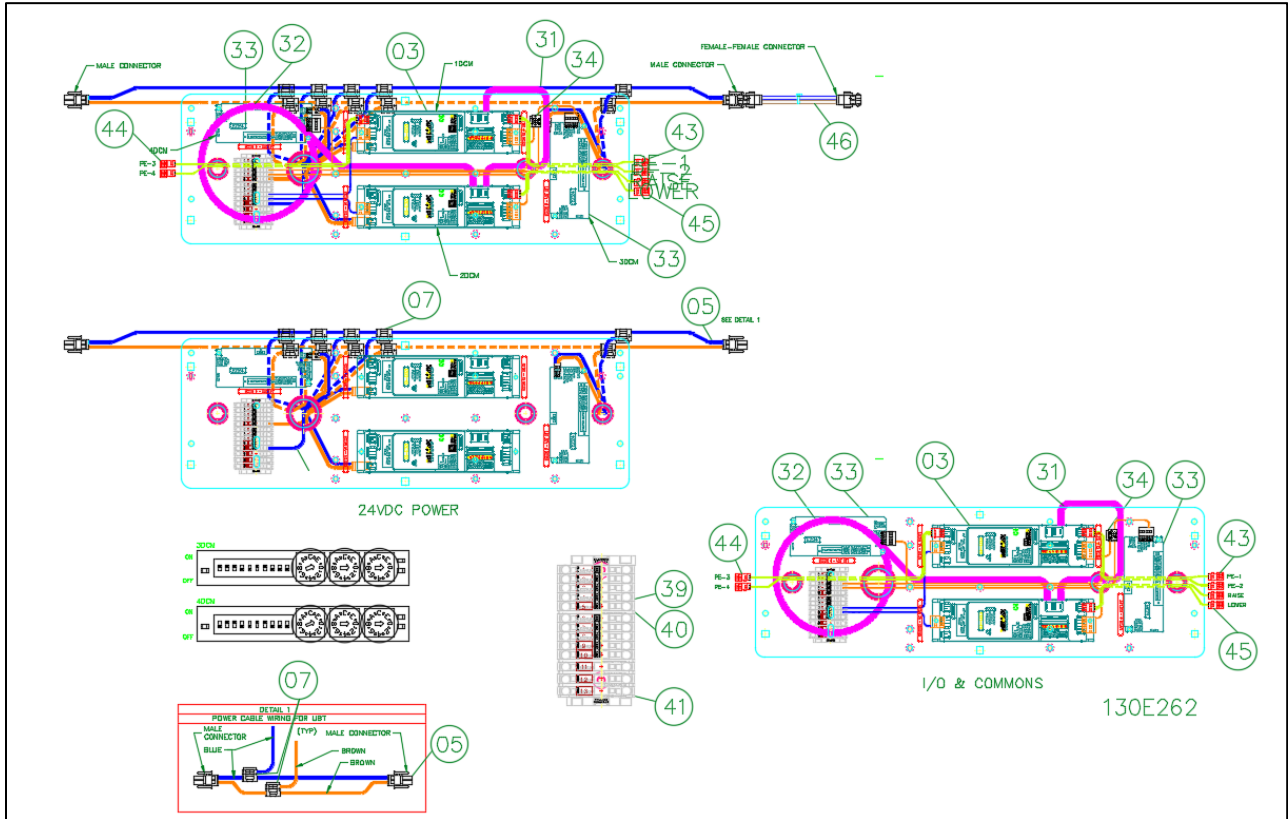

18.49.1 Replacement Parts – ITR UBT (Electric Lift) - Electrical Components IB-E03, 5s & 6s

REPLACEMENT PARTS - ITR UBT (ELECTRIC LIFT) ELECTRICAL COMPONENTS, BI-DIRECTIONAL, IBE, 5S OR 6S					
UBT,ITR-_BF-IBE-C6-5S OR 6S-BD-FE60-_MR-ELIFT-W/PE		Width & Item #			
Balloon	Description	16 BF	22 BF	28 BF	34 BF
----	ELECTRICAL COMPONENTS	----	----	----	----
03	DRIVERCARD,ITOH IB-E03BP	1166286	1166286	1166286	1166286
----	PE,REFLEX TYPE ZL, PNP,LIGHT OPERATE	1163456	1163456	1163456	1163456
----	PE,REFLECTOR 20MM X 30MM ADHESIVE BACKED	1136359	1136359	1136359	1136359
12/05	HARNES,POWER,10AWG	REFERENCE HARNESS TABLES			
06	CONN,WAGO 231-302/026-000	1162204	1162204	1162204	1162204
07	CONNECTOR,IDC SCOTCH LOK 567 - BROWN	3M567	3M567	3M567	3M567
31 & 32	CABLE,CTRLS-CAT5E-_-GRAY	REFERENCE Cat5E COMMUNICATION CABLE			
33	DRIVERCARD,INSIGHT EZ24 HTBS HIGH TORQUE PULSE ROLLER	1173108	1173108	1173108	1173108
34	CONNECTOR,IDC SCOTCH LOK 558 - RED	1120174	1120174	1120174	1120174
39	TERM,BLOCK,2-COND,20-10AWG600V,30A,GRAY,6.2mm	1145413	1145413	1145413	1145413
40	TERM,SEPARATOR,ORANGE,2mm	1180509	1180509	1180509	1180509
41	TERM,END BARRIER,GRAY,1mm	1145415	1145415	1145415	1145415
Reference Dwg: 130E262					

18.50 ITR UBT LIFT TABLE TRANSFER OPTIONAL SPARE PARTS



18.50.1 Optional Replacement Parts – ITR Lift Table Transfer

Optional Replacement Part Numbers Lift Table Transfer	
ITEM #	DESCRIPTION
E0009398	BRG,BUSHING THOMSON A-162536
E0009399	RING,GRIP THOMSON W 1000
Dwg# 130W003	

18.51 ITR GATE

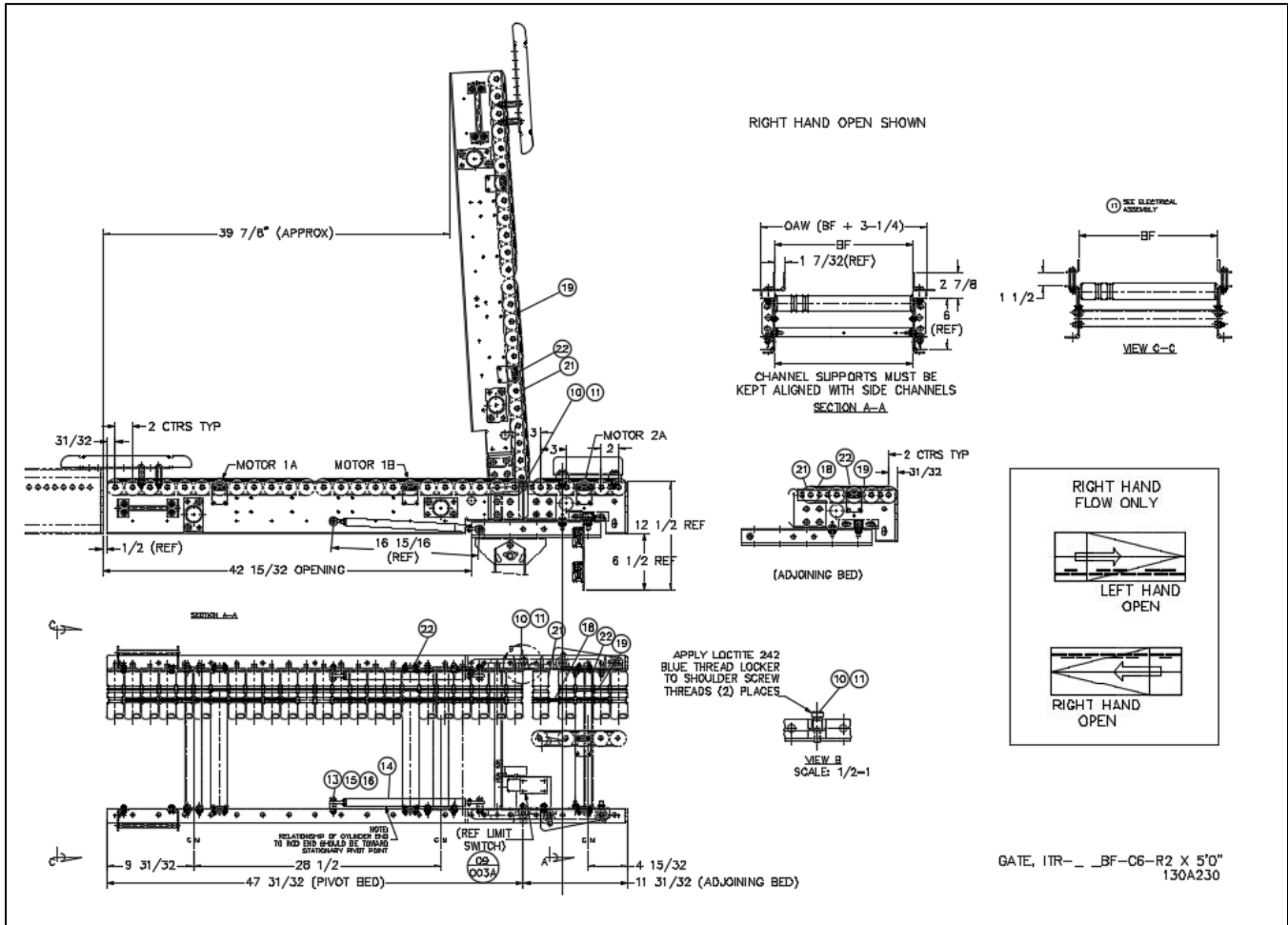

18.51.1 ITR Gate, Electrical with Limit Switch CBM-105

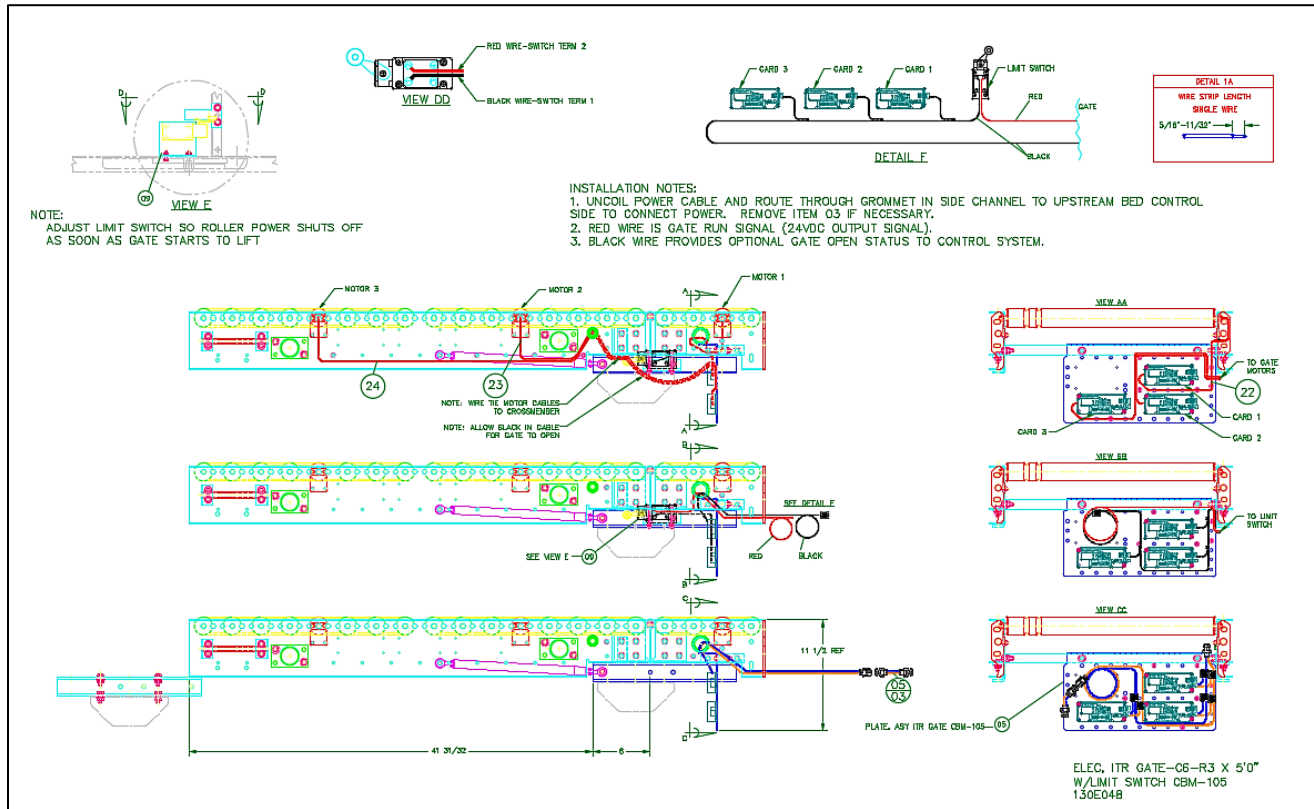

18.51.2 ITR Gate, Plate Assembly Electrical Components CBM-105

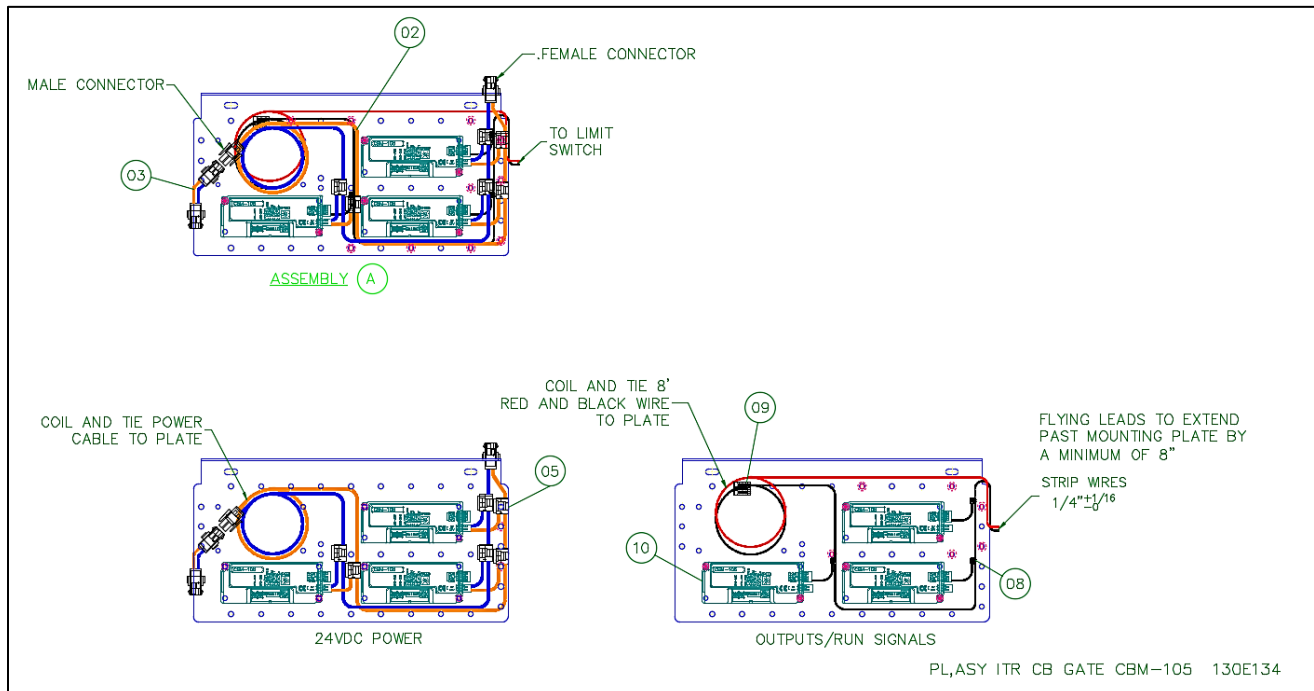

18.51.3 Replacement Parts – ITR Gate, CBM-105, 2RC & 3RC

REPLACEMENT PARTS - ITR GATE, CB, 2RC & 3RC					
GATE, ITR-__BF CB-C6-(2RC OR 3RC)-__"-FE60		Width & Item #			
Balloon	Description	16 BF	22 BF	28 BF	34 BF
1	ADJOINING GATE	---	---	---	---
19	ORING, 3/16DIA X 9.5" HT BLUE ITR 3"CTR (USED WITH 3RC)	E0005536	E0005536	E0005536	E0005536
18	ORING, 3/16DIA X 9.5" HT BLUE ITR 3"CTR (USED WITH 2RC)	E0005536	E0005536	E0005536	E0005536
19	ORING, 3/16DIA X 7-3/4" HT BLUE ITR 2"CTR (USED WITH 2RC)	1142656	1142656	1142656	1142656
21	ROLLER, __ITR 1.9PLTD PRBG	E0002412	E0002413	E0002414	E0006220
22	ROLLER, ITR __6BF 2G ITOH	1138722	1138723	1138724	1138725
2	PIVOT GATE	---	---	---	---
10	BRG, BRONZE BOSTON FB-810-5	90050017	90050017	90050017	90050017
14	SPRING, GAS 16-4, ___ NEWTONS (USED WITH 2RC)	1115812	E0004269	E0004270	E0004271
14	SPRING, GAS 16-4, ___ NEWTONS (USED WITH 3RC)	E0004267	E0004268	E0004269	E0004270
16	ROD, END PLAIN SPHERICAL DURBAL	E0003165	E0003165	E0003165	E0003165
19	ORING, 3/16DIA X 7-3/4" HT BLUE	1142656	1142656	1142656	1142656
11	ELEC, GATE, ITR IB-E03, LIMIT SWITCH	---	---	---	---
22	CABLE, MOTOR EXTENSION, 600MM USE W/ CB-016 OR HB-510	1138704	1138704	1138704	1138704
23	CABLE, MOTOR EXTENSION, 1200MM USE W/ CB-016 OR HB-510	1138705	1138705	1138705	1138705
24	CABLE, MOTOR EXTENSION, 2700MM USE W/ CB-016 OR HB-510	1138706	1138706	1138706	1138706
11/05	PL, ASY ITR GATE CB	---	---	---	---
2	HARNESS, ITR-POWER-10AWG 5.5'	1102288	1102288	1102288	1102288
3	HARNESS, ITR-POWER-10AWG, 4"-FEMALE/FEMALE CONN	1141549	1141549	1141549	1141549
5	CONNECTOR, IDC SCOTCHLOK 567	3M567	3M567	3M567	3M567
8	CONNECTOR, IDC SCOTCHLOK 558 - RED	1120174	1120174	1120174	1120174
9	CONN, 3 COND, W/LEVERS	1102816	1102816	1102816	1102816
10	DRIVERCARD, ITOH CBM-105FP	1153930	1153930	1153930	1153930
11/09	ASY, GATE LIMIT SWITCH ITR	---	---	---	---
003A	SWITCH, LIMIT 802T-AP AB	802TAP	802TAP	802TAP	802TAP

Ref Dwg# 130A230, 130E048, 130E134

18.51.4 ITR Gate, Electrical with Limit Switch IB-E03

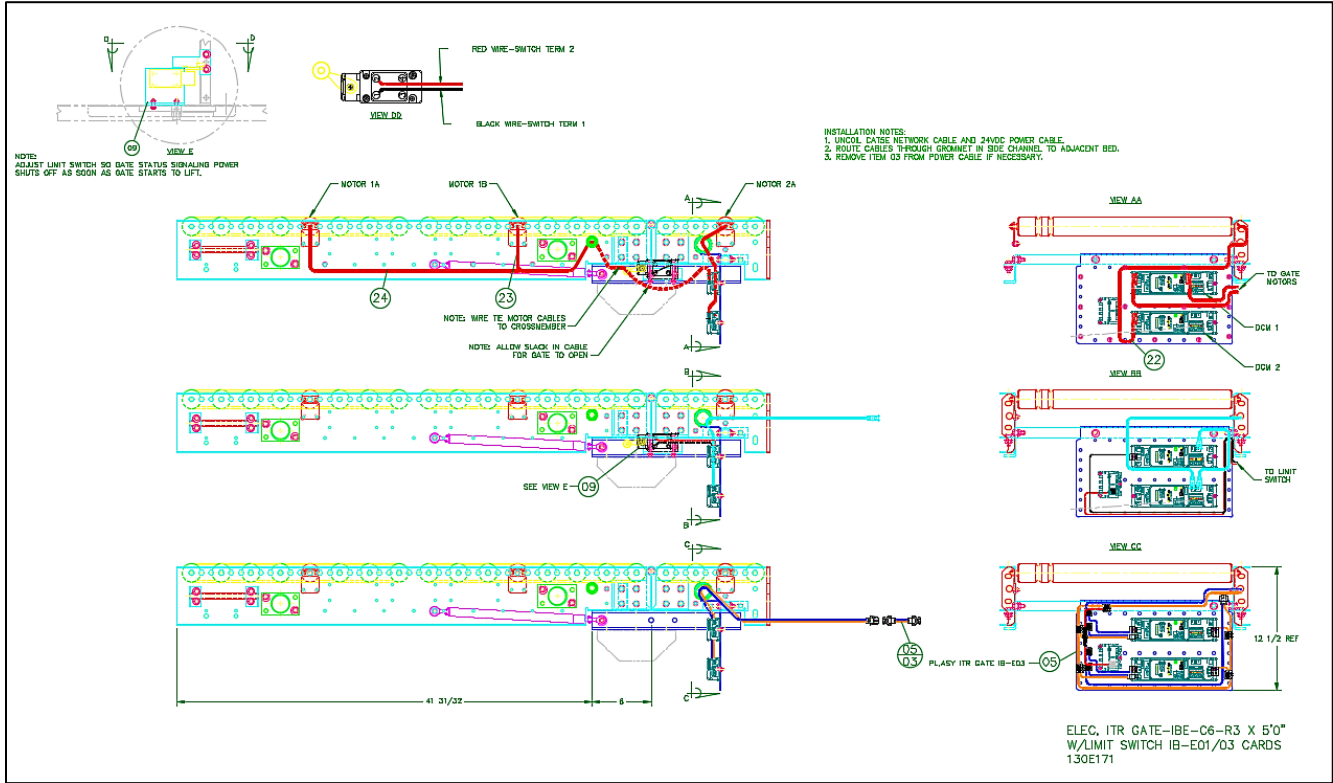

18.51.5 ITR Gate, Plate Assembly Electrical Components IB-E03

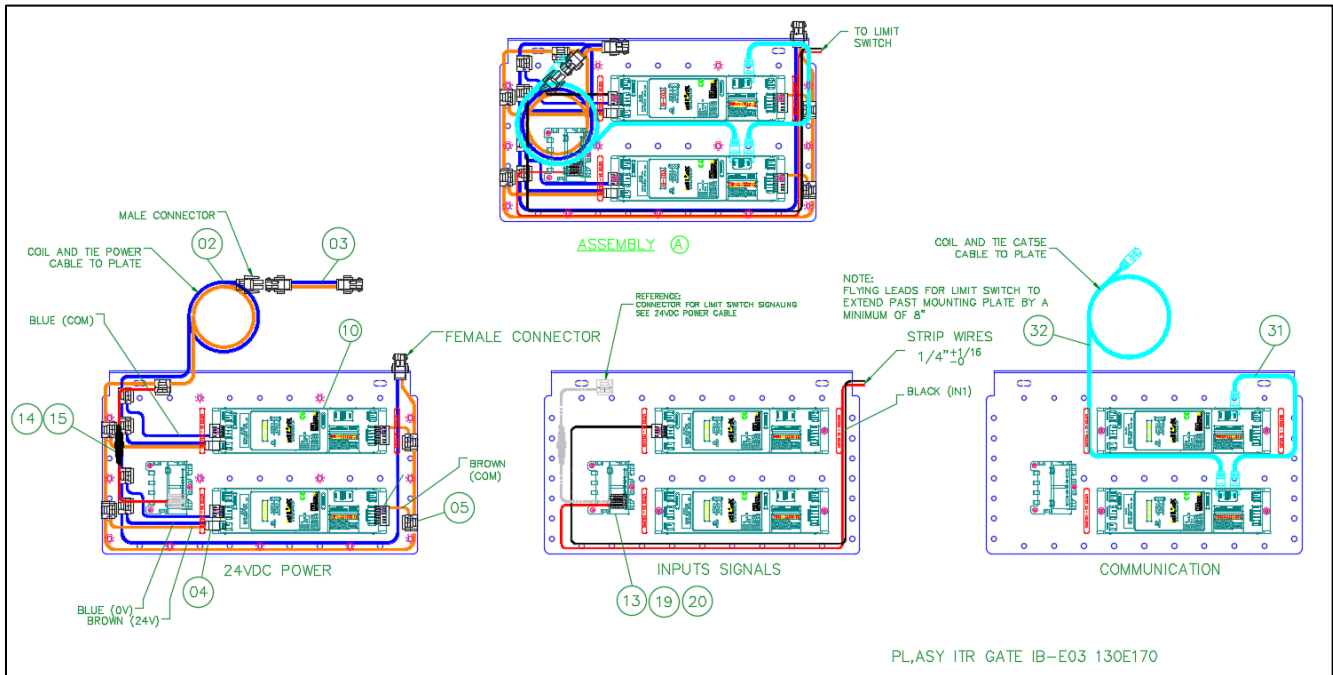

18.51.6 Replacement Parts – ITR Gate, 2RC & 3RC, IB-E03

REPLACEMENT PARTS - ITR GATE, IBE, 2RC & 3RC					
GATE, ITR-__BF IBE-C6-(2RC OR 3RC)-__-FE60		Width & Item #			
Balloon	Description	16 BF	22 BF	28 BF	34 BF
1	ADJOINING GATE	---	---	---	---
19	ORING, 3/16DIA X 9.5" HT BLUE ITR 3"CTR (USED WITH 3RC)	E0005536	E0005536	E0005536	E0005536
18	ORING, 3/16DIA X 9.5" HT BLUE ITR 3"CTR (USED WITH 2RC)	E0005536	E0005536	E0005536	E0005536
19	ORING, 3/16DIA X 7-3/4" HT BLUE ITR 2"CTR (USED WITH 2RC)	1142656	1142656	1142656	1142656
21	ROLLER, __ITR 1.9PLTD PRBG	E0002412	E0002413	E0002414	E0006220
22	ROLLER, ITR __BF 2G ITOH PM486 FE-60	1163471	1163472	1163473	1163474
2	PIVOT GATE	---	---	---	---
10	BRG, BRONZE BOSTON FB-810-5	90050017	90050017	90050017	90050017
14	SPRING, GAS 16-4, ___ NEWTONS (USED WITH 2RC)	E0004268	1205446	E0004270	E0004271
14	SPRING, GAS 16-4, ___ NEWTONS (USED WITH 3RC)	E0004267	E0004268	E0004269	E0004270
16	ROD, END PLAIN SPHERICAL DURBAL	E0003165	E0003165	E0003165	E0003165
21	ROLLER, __ITR 1.9PLTD PRBG	E0002412	E0002413	E0002414	E0006220
11	ELEC, GATE, ITR IB-E03, LIMIT SWITCH	---	---	---	---
22	CABLE, MOTOR EXTENSION, 600MM USE W/ IB-N03/IB-E/HBM-604/BRAKE	1135339	1135339	1135339	1135339
23	CABLE, MOTOR EXTENSION, 1200MM USE W/ IB-N03/IB-E/HBM-604/BRAKE	1135340	1135340	1135340	1135340
24	CABLE, MOTOR EXTENSION, 2700MM USE W/ IB-N03/IB-E/HBM-604/BRAKE	1135341	1135341	1135341	1135341
11/05	PL, ASY ITR GATE IB-E03	---	---	---	---
2	HARNESS, ITR-POWER-10AWG 5.5'	1102288	1102288	1102288	1102288
3	HARNESS, ITR-POWER-10AWG, 4"-FEMALE/FEMALE CONN	1141549	1141549	1141549	1141549
4	CONN, WAGO 231-302/026-000	1162204	1162204	1162204	1162204
5	CONNECTOR, IDC SCOTCHLOK 567	3M567	3M567	3M567	3M567
10	DRIVERCARD, ITOH IB-E03BP	1166286	1166286	1166286	1166286
13	CONN, 3 COND, W/LEVERS	1102816	1102816	1102816	1102816
14	FUSE, 4A, 125V, CARTRIDGE, GMA	1102221	1102221	1102221	1102221
15	FUSE, HOLDER IN-LINE, CARTRIDGE	1102222	1102222	1102222	1102222
31	CABLE, CTRLS-CAT5E-3'-GRAY	E0034025	E0034025	E0034025	E0034025
32	CABLE, CTRLS-CAT5E-5'-GRAY	E0034026	E0034026	E0034026	E0034026
11/09	ASY, GATE LIMIT SWITCH ITR	---	---	---	---
003A	SWITCH, LIMIT 802T-AP AB	802TAP	802TAP	802TAP	802TAP

Ref Dwg# 130A230, 130E170, 130E171

INTELLIROL REVISION HISTORY

Revision Date	Chapter and Description	Initials
4/16/2021	<p>Pneumatic Requirements</p> <ol style="list-style-type: none"> 1. A more accurate name for pop-off is pressure-relief. 2. This is not a switch but a valve (just vents to atmosphere) 3. Pressure settings above and below operating range are general recommendations, subject to the accuracy of the devices. 4. Pneumatic actuators used in ITR product line are rated for high pressure, 45 psi pressure-relief valve could be considered unnecessary. 	CN /SL
04/16/2021	Spare Parts Chapter - Updated drawings 130A034-038 & 130A640-643	DG
07/6/2021	Added optional spare parts for Transfer Lift Table	AB CN
08/10/2021	Add merge bracket kit part number 1208351 for clarity per ECN 11891.	EN EB DP
09/22/2021	Added MHS Conveyor name, logo, and format	AB MD
12/08/2021	Updated Coated Roller part list descriptions	AB / DG
08/08/2022	Add Description of Operation chapter	TE
08/08/2022	Removed Noseover and Noseunder Decline 15 Degrees	DG
09/06/2022	Add safety warnings	MM
11/04/2022	Updated chapter 15.6 IB-E03 ELECTRICAL COMPONENTS chart to include Photoeye	MD CN
01/31/2023	Update Shroud part list. No new revision	MD
02/16/2023	Spare Parts section Noseover and Noseunder updated belt part numbers.	DG

WORKS CITED

- CEMA. (2014). *Conveyor Equipment Manufacturers Association*. Retrieved 2014, from Conveyor Equipment Manufacturers Association: <http://www.cemanet.org/>
- DENKI, I. (2014). *ITOH DENKI* . Retrieved 1 14, 2015, from <http://itohdenki.com/>
- OSHA. (2014). *Occupational Safety & Health Administration*. Retrieved 2014, from OSHA QuickTakes: <https://www.osha.gov/>

MHS CONVEYOR GENERAL INFORMATION

For additional manuals, videos, and other resources visit our website at:

mhs-conveyor.com

ABOUT MHS CONVEYOR

About MHS Conveyor

MHS Conveyor, located in Norton Shores, Michigan, is a leading deliverer of “smart” material handling systems, technologies, products, and services, creating solutions for material flow applications. As a global supplier of conveyor systems and equipment since 1964, MHS Conveyor provides sorters, conveyors, and accessories to satisfy a broad spectrum of accumulation, transportation, and sortation applications.



MHS Conveyor Corp.
1300 E. Mount Garfield Road
Norton Shores MI 49441-6097 USA
231.798.4547
Email : usinfo@mhs-conveyor.com
Web Site : mhs-conveyor.com



Regional sales offices and authorized Business Partners located throughout the United States and Canada. Licensees and Business Partners in Europe, South America, and Southeast Asia.